

Audio Limiter

■ GENERAL DESCRIPTION

The **NJM2761** is the audio limiter for speaker protection. The limit level is adjustable by external resistor. It is suitable for PC, portable audio and others.

■ PACKAGE OUTLINE



NJM2761RB2

■ FEATURES

- Wide Operating Voltage +2.7V to +13.0V
- Variable Limit Level by external resistor 0.2 to 1V
- Low Output Noise -90dBV max.
- Bipolar Technology
- Package Outline TVSP10

■ PIN CONFIGURATION

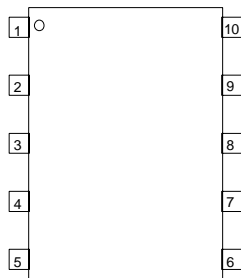

1. V+
2. OUTa
3. INa
4. INT
5. VREF
6. SENCE
7. SW
8. INb
9. OUTb
10. GND

■ BLOCK DIAGRAM

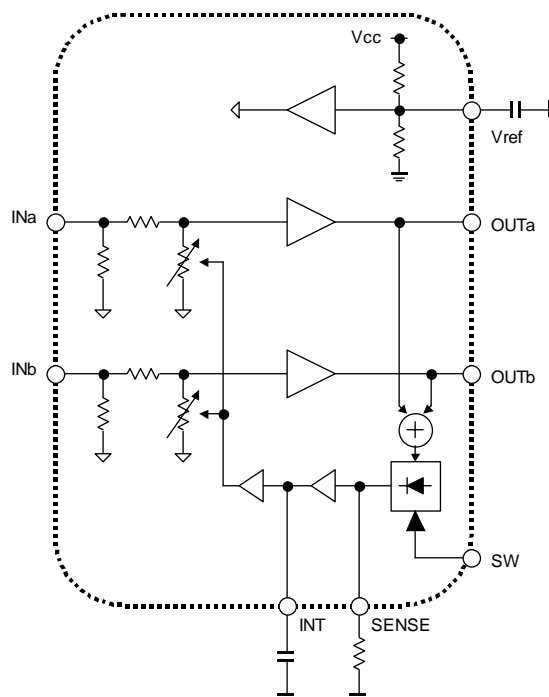

NJM2761

■ABSOLUTE MAXIMUM RATING (Ta=25°C)

PARAMETER	SYMBOL	RATINGS	UNIT
Supply Voltage	V ⁺	14	V
Power Dissipation	P _D	320	mW
Operating Temperature Range	T _{opr}	-20 to +75	°C
Storage Temperature Range	T _{stg}	-40 to +125	°C

■ELECTRICAL CHARACTERISTICS

● POWER SUPPLY (Ta=25°C, V⁺=5V unless otherwise specified)

PARAMETER	SYMBOL	TEST CONDITION	MIN.	TYP.	MAX.	UNIT
Operating Voltage	V ⁺	-	2.7	5.0	13.0	V
Operating Current	I _{CC}	No Signal	-	1.5	2.0	mA
Reference Voltage	V _{ref}	No Signal	2.2	2.5	2.7	V

● AC CHARACTERISTICS

(Ta=25°C, V⁺=5V, V_{IN}=1V_{rms}/f=1kHz, R_{sense}=20kΩ, BW=400-30kHz unless otherwise specified)

PARAMETER	SYMBOL	TEST CONDITION	MIN.	TYP.	MAX.	UNIT
Limit Level 1	G _{LIM1}		150	200	250	mV _{rms}
Limit Level 2	G _{LIM2}	V ⁺ =13V, R _{sense} =4kΩ	0.7	1.0	1.3	V _{rms}
Limit Off	G _{OFF}	SW=2V	0.9	1.0	1.1	V _{rms}
Output Noise	V _{NO}	R _S =0Ω, A-weighting, V _{IN} =2V _{rms}	-	-100 (10)	-90 (31.6)	dBV (μV _{rms})
Total Harmonic Distortion	THD+N		-	-	1	%
Cross Talk	CT		-	-	-70	dB
Ripple Rejection	RR	V _{ripple} =100mV _{rms} , f=1kHz	-	-	-70 (316)	dBV (μV _{rms})

● CONTROL CHARACTERISTICS (Ta=25°C, V⁺=5V unless otherwise specified)

PARAMETER	SYMBOL	TEST CONDITION	MIN.	TYP.	MAX.	UNIT
Low Level Input Voltage	V _{IL}	-	-	-	0.5	V
High Level Input Voltage	V _{IH}	-	2.0	-	-	V

■CONTROL TERMINAL EXPLANATION

SW(7pin)

MODE	STATUS	NOTE
Limiter ON	L	Limiter is active.
Limiter OFF	H	Limiter is not active.

■TERMINAL DESCRIPTION

No.	SYMBOL	FUNCTION	EQUIVALENT CIRCUIT	VOLTAGE
1	V+	Power Supply Terminal	—	-
2 9	OUTa OUTb	Ach Output Terminal Bch Output Terminal		$V+/2$
3 8	INa INb	Ach Input Terminal Bch Input Terminal		$V+/2$
4	INT	Smoothing Capacitor Connection Terminal		0.7V
5	VREFIN	Reference Voltage Stabilizing Capacitor Connection Terminal		$V+/2$

NJM2761

■TERMINAL DESCRIPTION

No.	SYMBOL	FUNCTION	EQUIVALENT CIRCUIT	VOLTAGE
6	SENSE	Resister Connection Terminal for Limit Level Setting		0V
7	SW	Limiter ON/OFF Switch		-
10	GND	Ground Terminal		-

APPLICATION CIRCUIT

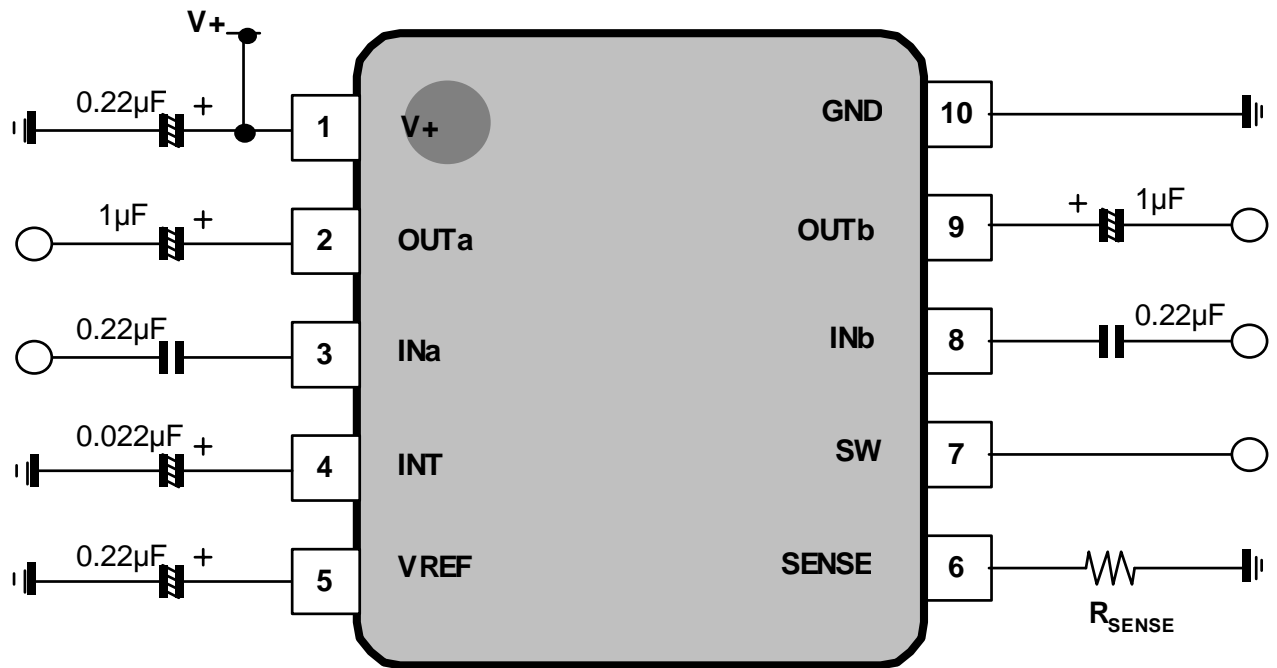

$$R_{\text{SENSE}} = 4000 / V_{\text{LIMIT}} [\Omega]$$

NJM2761

TYPICAL CHARACTERISTICS

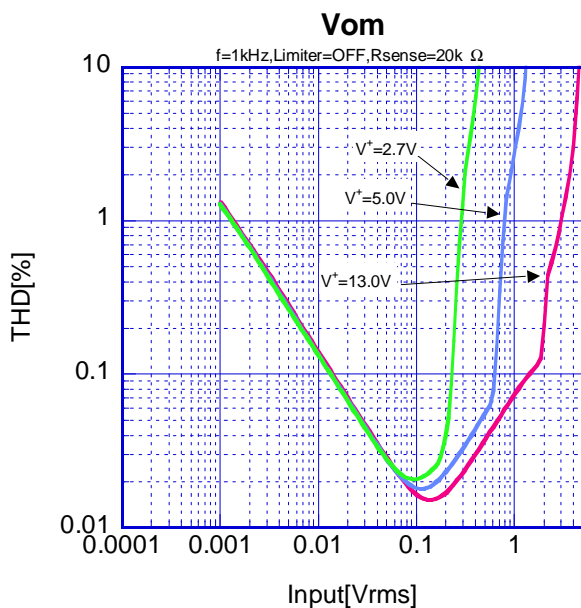
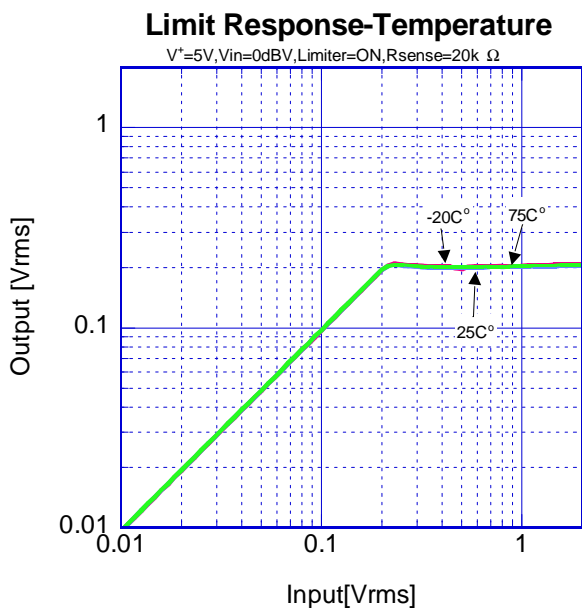
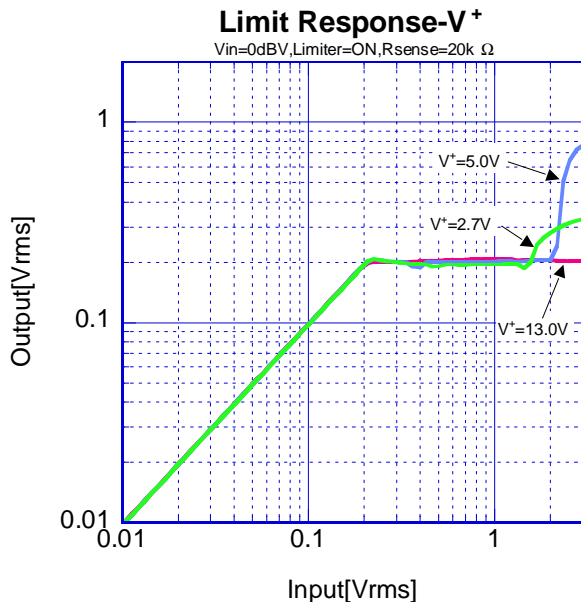
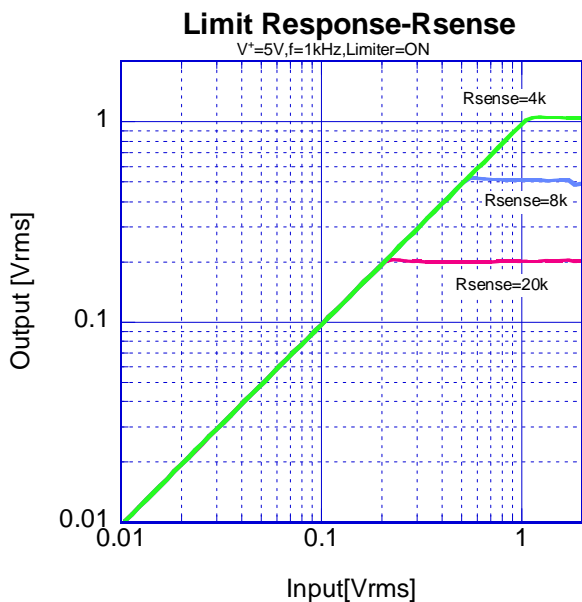
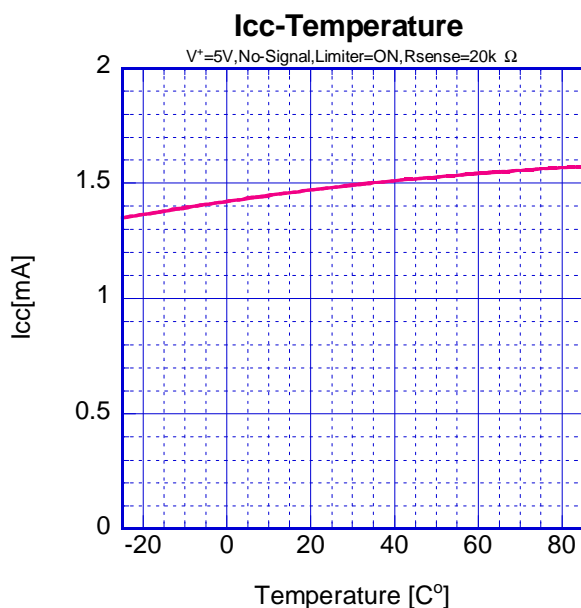
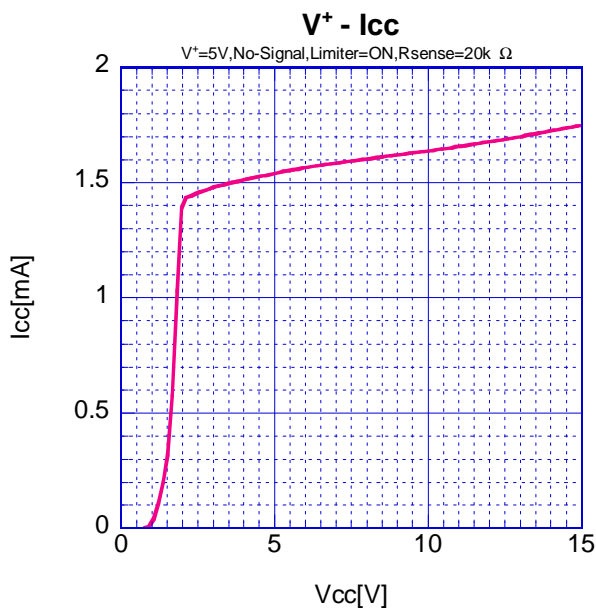

TYPICAL CHARACTERISTICS

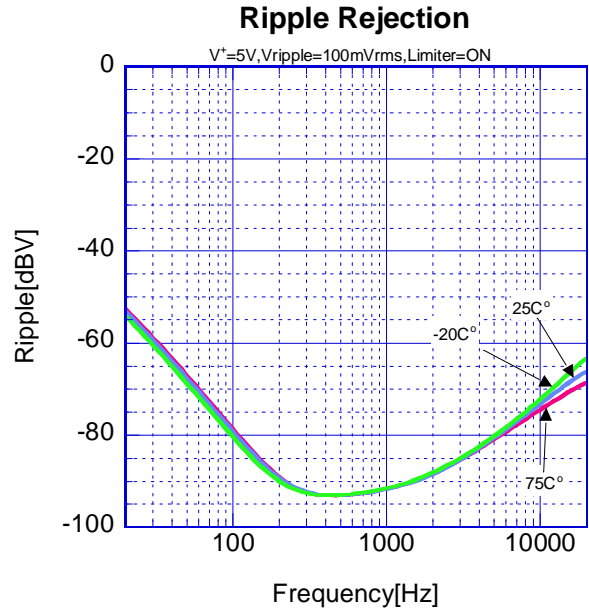
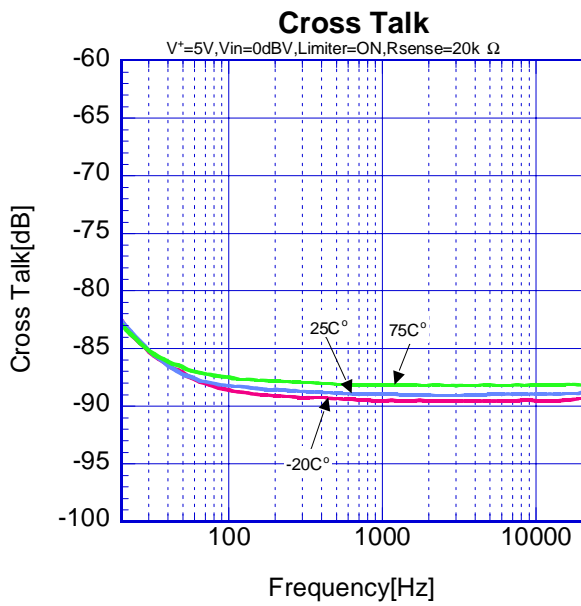
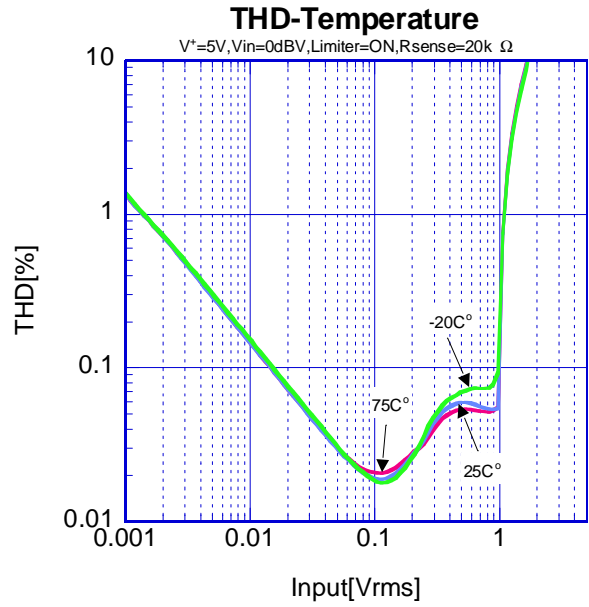
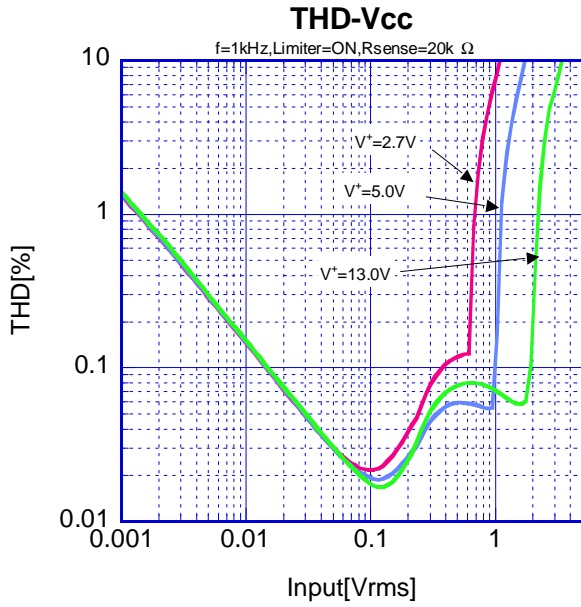

[CAUTION]
The specifications on this databook are only given for information, without any guarantee as regards either mistakes or omissions. The application circuits in this databook are described only to show representative usages of the product and not intended for the guarantee or permission of any right including the industrial rights.