

TOSHIBA TRANSISTOR SILICON NPN EPITAXIAL PLANAR TYPE (PCT PROCESS)

2SC2668

HIGH FREQUENCY AMPLIFIER APPLICATIONS.
FM, RF, IF AMPLIFIER APLIFIER APPLICATIONS.

Unit in mm

- Small Reverse Transfer Capacitance : $C_{re}=0.70\text{pF}$ (Typ.)
- Low Noise Figure : $NF=2.5\text{dB}$ (Typ.)

MAXIMUM RATINGS (Ta = 25°C)

CHARACTERISTIC	SYMBOL	RATING	UNIT
Collector-Base Voltage	V_{CBO}	40	V
Collector-Emitter Voltage	V_{CEO}	30	V
Emitter-Base Voltage	V_{EBO}	4	V
Collector Current	I_C	20	mA
Emitter Current	I_B	4	mA
Collector Power Dissipation	P_C	100	mW
Junction Temperature Range	T_j	125	°C
Storage Temperature Range	T_{stg}	-55~125	°C

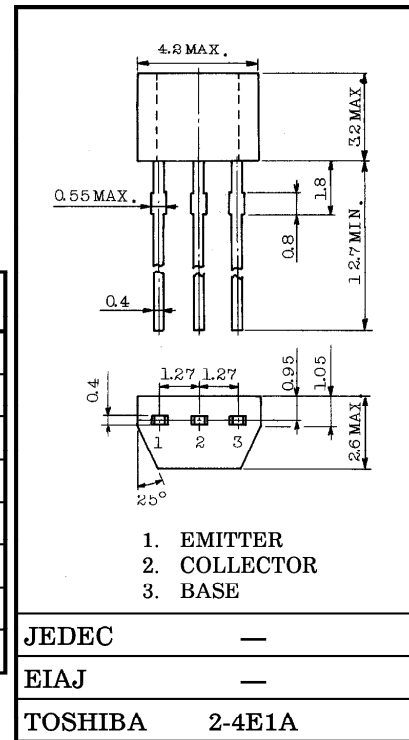

Weight : 0.13g

ELECTRICAL CHARACTERISTICS (Ta = 25°C)

CHARACTERISTIC	SYMBOL	TEST CONDITION	MIN.	TYP.	MAX.	UNIT
Collector Cut-off Current	I_{CBO}	$V_{CB}=40\text{V}, I_E=0$	—	—	0.5	μA
Emitter Cut-off Current	I_{EBO}	$V_{EB}=4\text{V}, I_C=0$	—	—	0.5	μA
DC Current Gain	h_{FE} (Note)	$V_{CE}=6\text{V}, I_C=1\text{mA}$	40	—	200	—
Reverse Transfer Capacitance	C_{re}	$V_{CE}=6\text{V}, f=1\text{MHz}$	—	0.70	—	pF
Transistion Frequency	f_T	$V_{CE}=6\text{V}, I_C=1\text{mA}$	—	550	—	MHz
Collector-Base Time Constant	$C_c \cdot r_{bb}'$	$V_{CE}=6\text{V}, I_E=-1\text{mA}, f=30\text{MHz}$	—	—	30	ps
Noise Figure	NF	$V_{CC}=6\text{V}, I_E=-1\text{mA}, f=100\text{MHz}$ (Fig.1)	—	2.5	5.0	dB
Power Gain	G_{pe}		—	18	—	dB

Note : h_{FE} Classification R : 40~80, O : 70~140, Y : 100~200

961001EAA2

- TOSHIBA is continually working to improve the quality and the reliability of its products. Nevertheless, semiconductor devices in general can malfunction or fail due to their inherent electrical sensitivity and vulnerability to physical stress. It is the responsibility of the buyer, when utilizing TOSHIBA products, to observe standards of safety, and to avoid situations in which a malfunction or failure of a TOSHIBA product could cause loss of human life, bodily injury or damage to property. In developing your designs, please ensure that TOSHIBA products are used within specified operating ranges as set forth in the most recent products specifications. Also, please keep in mind the precautions and conditions set forth in the TOSHIBA Semiconductor Reliability Handbook.
- The information contained herein is presented only as a guide for the applications of our products. No responsibility is assumed by TOSHIBA CORPORATION for any infringements of intellectual property or other rights of the third parties which may result from its use. No license is granted by implication or otherwise under any intellectual property or other rights of TOSHIBA CORPORATION or others.
- The information contained herein is subject to change without notice.

Fig.1. NF, G_{pe} TEST CIRCUIT

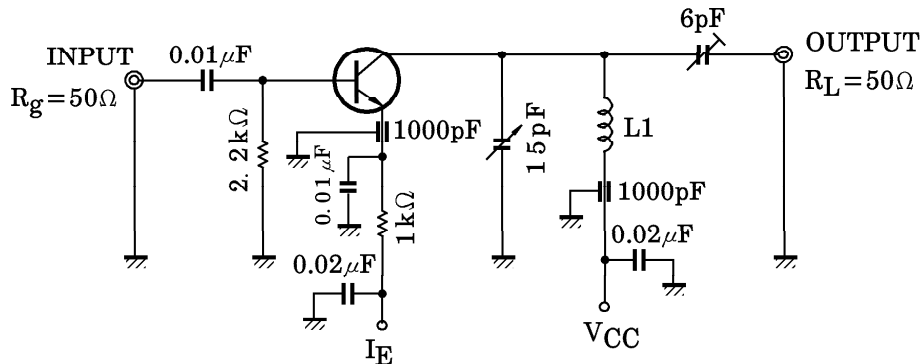

L1 : 0.8mm ϕ SILVER PLATED COPPER WIRE, 4Turns. 10mm ID, 8mm Lengh.

Y PARAMETER (Typ.)

(1) COMMON EMITTER ($V_{CE} = 6V, I_E = -1mA, f = 100MHz$)

CHARACTERISTIC	SYMBOL	TYP.	UNIT
Input Conductance	g_{ie}	2.9	ms
Input Capacitance	C_{ie}	10.2	pF
Reverse Transfer Admittance	$ Y_{re} $	0.33	ms
Phase Angle of Reverse Transfer Admittance	θ_{re}	-90	$^{\circ}$
Forward transfer Admittance	$ Y_{fe} $	40	ms
Phase Angle of Forward Transfer Admittance	θ_{fe}	-20	$^{\circ}$
Output Conductance	g_{oe}	45	μS
Output Capacitance	C_{oe}	1.1	pF

(2) COMMON BASE ($V_{CB} = 6V, I_E = -1mA, f = 100MHz$)

CHARACTERISTIC	SYMBOL	TYP.	UNIT
Input Conductance	g_{ib}	34	ms
Input Capacitance	C_{ib}	-10	pF
Reverse Transfer Admittance	$ Y_{rb} $	0.27	ms
Phase Angle of Reverse Transfer Admittance	θ_{rb}	-105	$^{\circ}$
Forward Transfer Admittance	$ Y_{fb} $	34	ms
Phase Angle of Forward Transfer Admittance	θ_{fb}	165	$^{\circ}$
Output Conductance	g_{ob}	45	μS
Output Capacitance	C_{ob}	1.1	pF

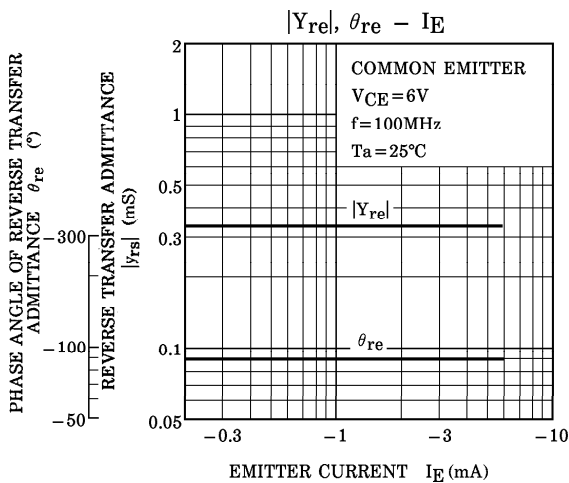
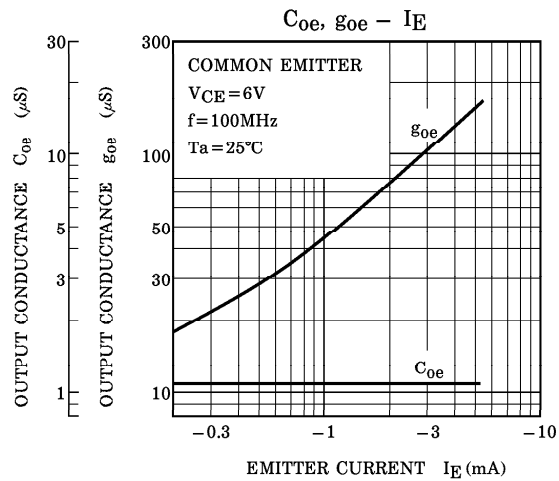
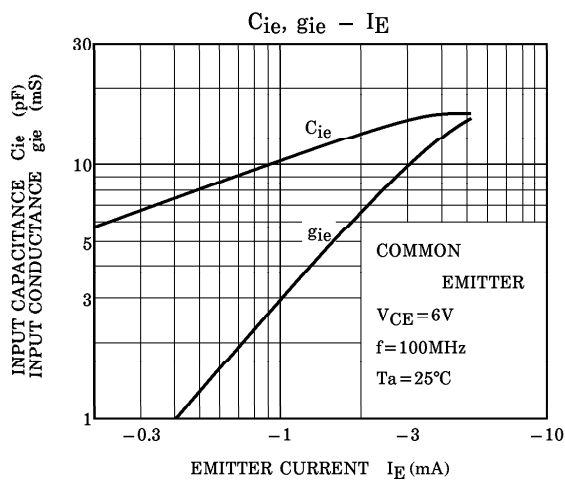
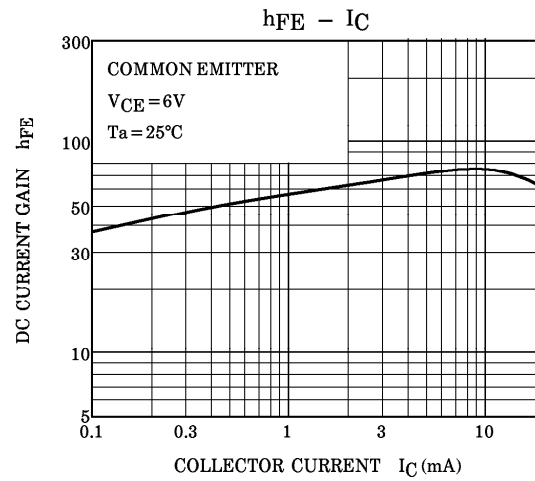
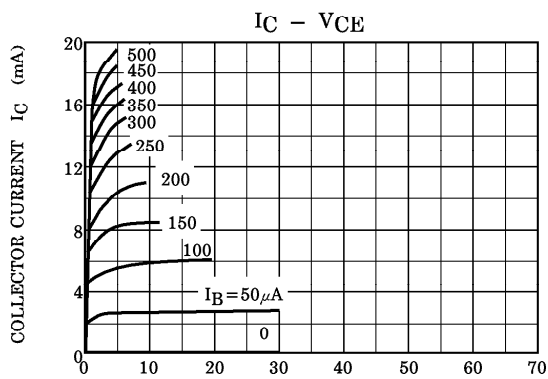

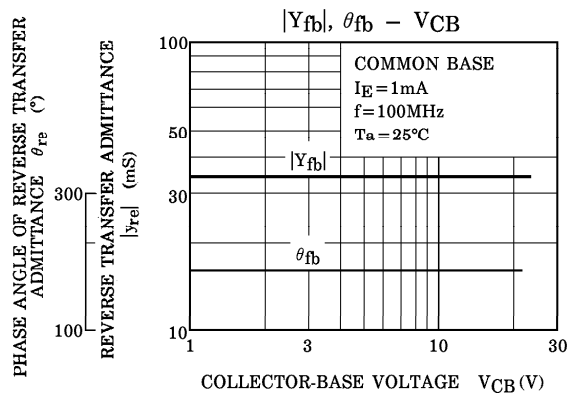
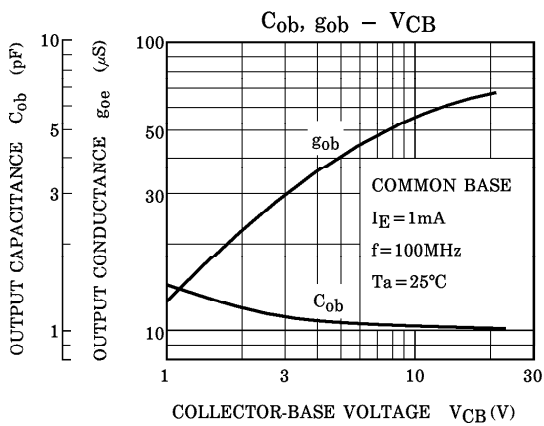
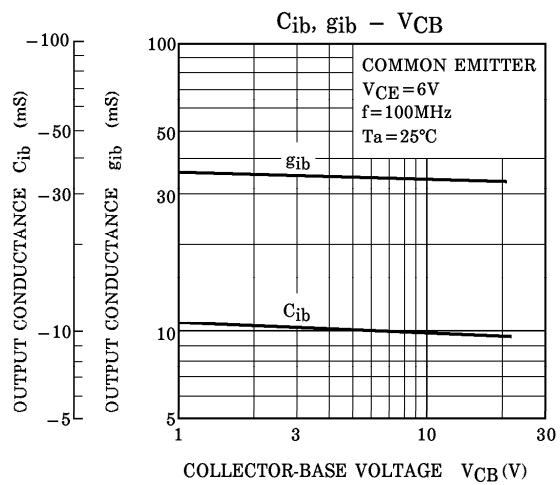
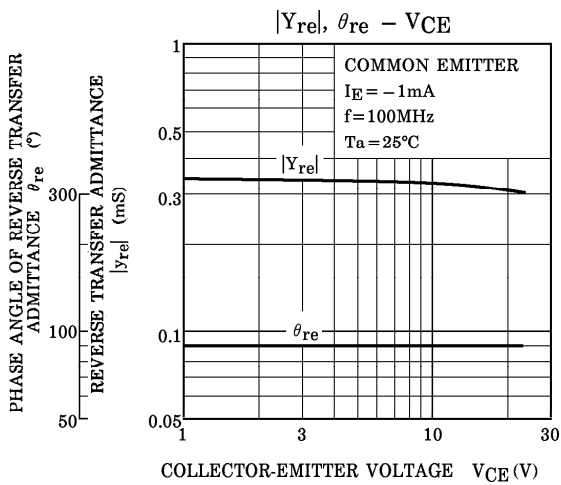
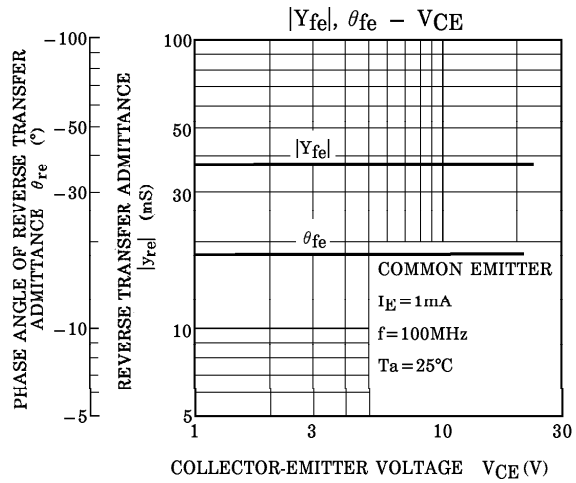
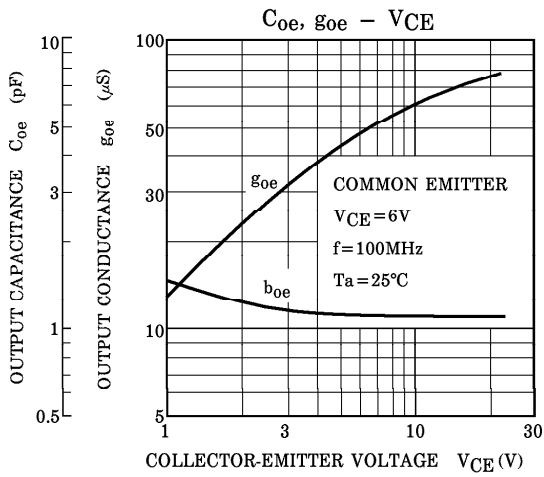

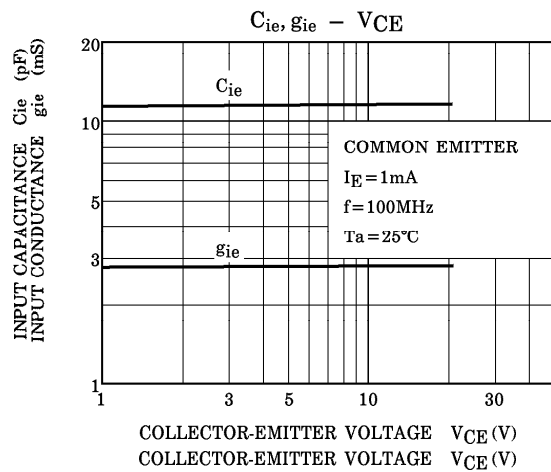
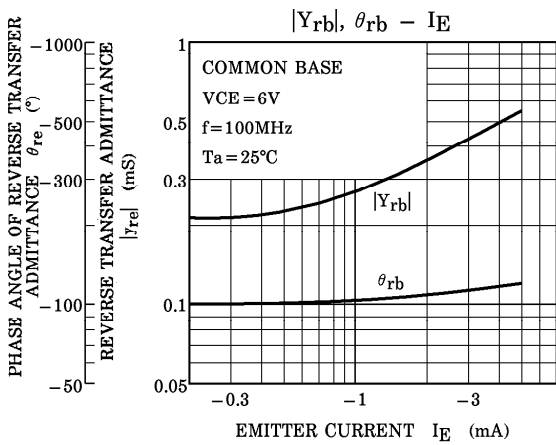
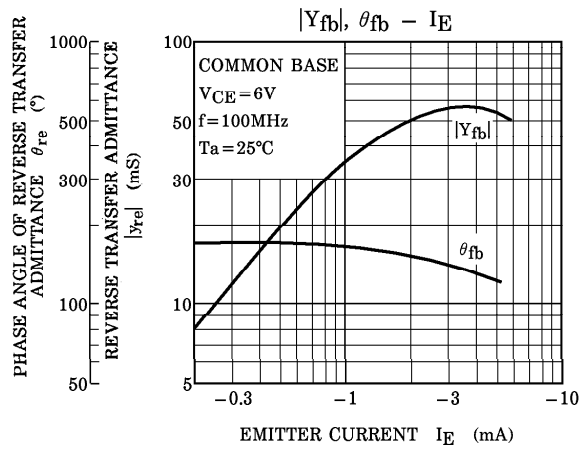
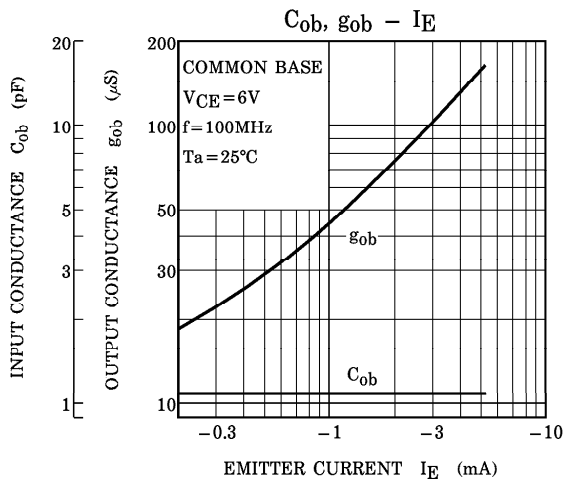
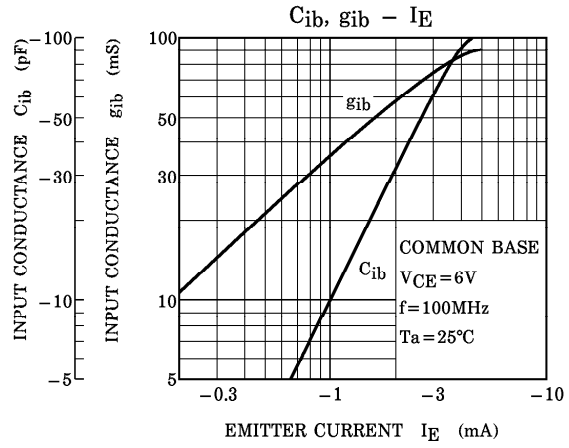
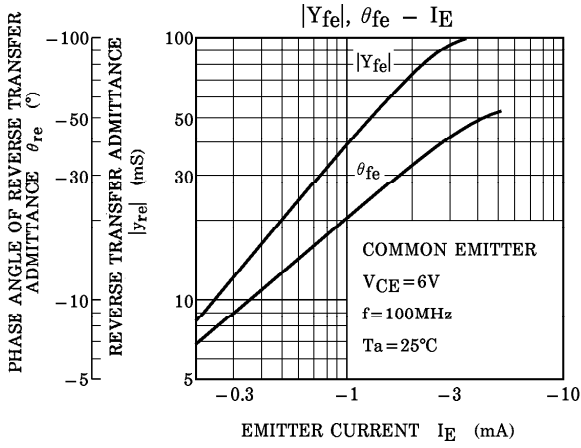

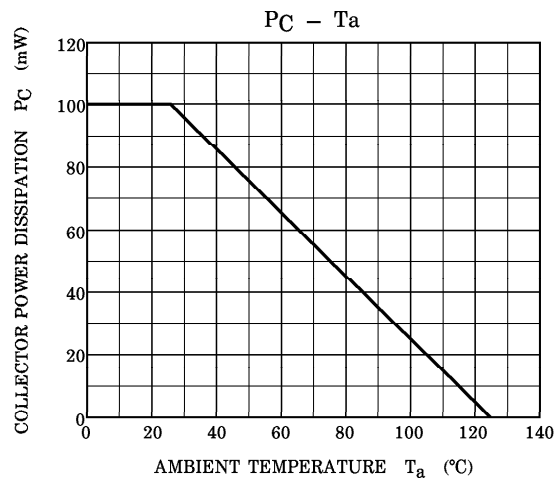
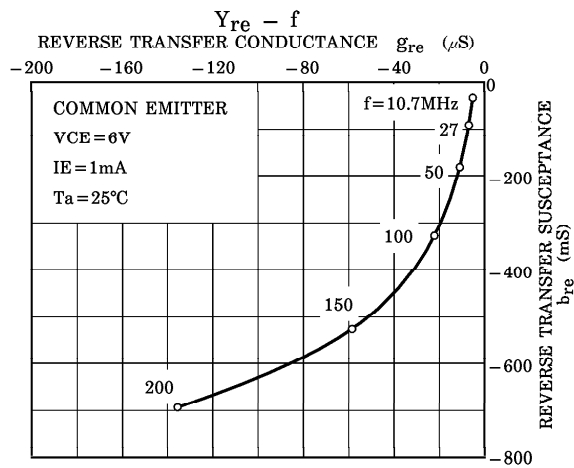
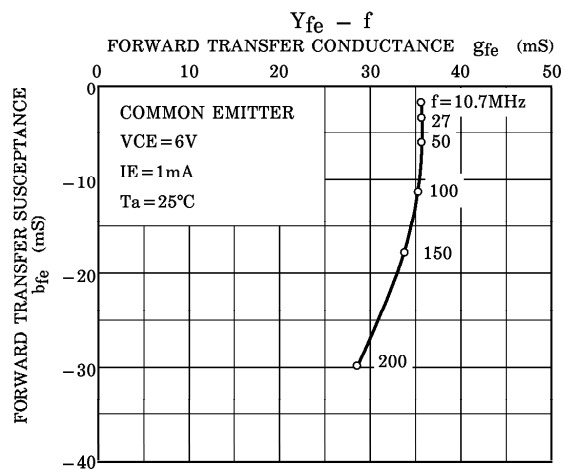
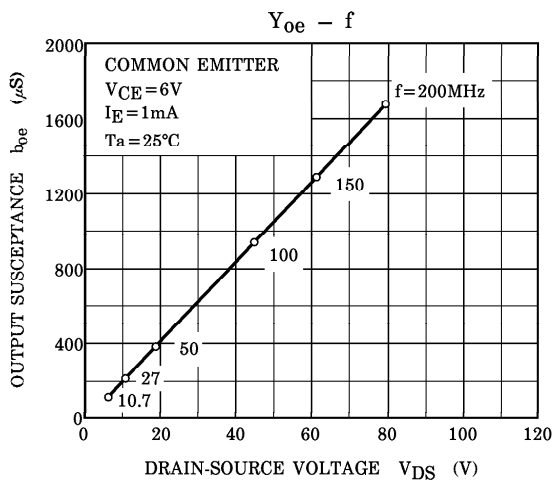
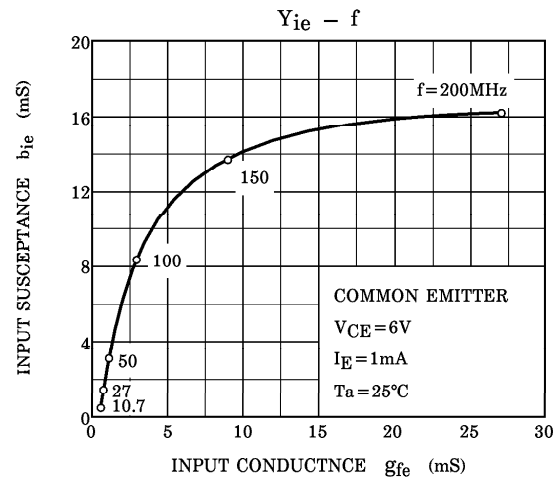
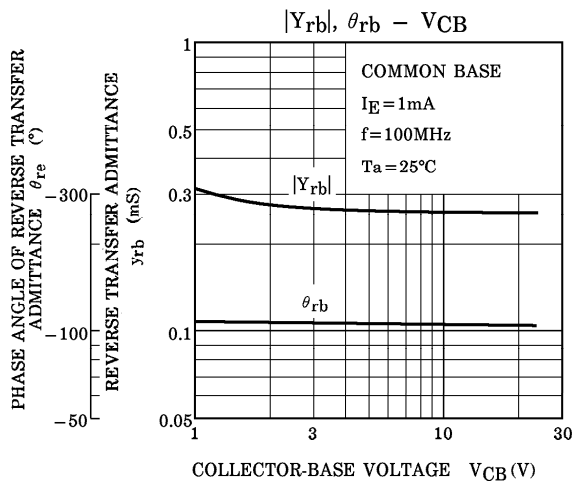

Copyright Each Manufacturing Company.

All Datasheets cannot be modified without permission.

This datasheet has been download from :

www.AllDataSheet.com

100% Free DataSheet Search Site.

Free Download.

No Register.

Fast Search System.

www.AllDataSheet.com