

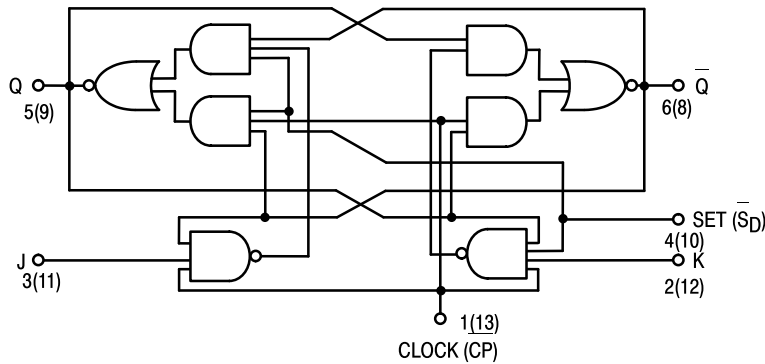

# DUAL JK NEGATIVE EDGE-TRIGGERED FLIP-FLOP

The SN54/74LS113A offers individual J, K, set, and clock inputs. These monolithic dual flip-flops are designed so that when the clock goes HIGH, the inputs are enabled and data will be accepted. The logic level of the J and K inputs may be allowed to change when the clock pulse is HIGH and the bistable will perform according to the truth table as long as minimum setup times are observed. Input data is transferred to the outputs on the negative-going edge of the clock pulse.

LOGIC DIAGRAM (Each Flip-Flop)



MODE SELECT — TRUTH TABLE

| OPERATING MODE   | INPUTS         |   |   | OUTPUTS |    |
|------------------|----------------|---|---|---------|----|
|                  | S <sub>D</sub> | J | K | Q       | Q̄ |
| Set              | L              | X | X | H       | L  |
| Toggle           | H              | h | h | q       | q  |
| Load "0" (Reset) | H              | l | h | L       | H  |
| Load "1" (Set)   | H              | h | l | H       | L  |
| Hold             | H              | l | l | q       | q  |

H, h = HIGH Voltage Level  
 L, l = LOW Voltage Level  
 X = Don't Care  
 l, h (q) = Lower case letters indicate the state of the referenced input (or output) one set-up time prior to the HIGH to LOW clock transition.

## SN54/74LS113A

DUAL JK NEGATIVE  
 EDGE-TRIGGERED FLIP-FLOP  
 LOW POWER SCHOTTKY

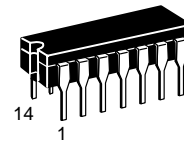

J SUFFIX  
 CERAMIC  
 CASE 632-08

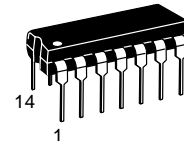

N SUFFIX  
 PLASTIC  
 CASE 646-06

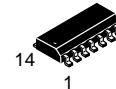

D SUFFIX  
 SOIC  
 CASE 751A-02

ORDERING INFORMATION

- SN54LSXXXJ Ceramic
- SN74LSXXXN Plastic
- SN74LSXXXD SOIC

LOGIC SYMBOL

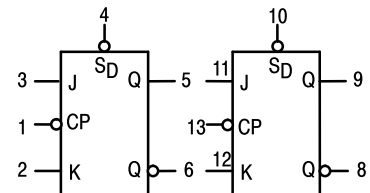

V<sub>CC</sub> = PIN 14  
 GND = PIN 7

# SN54/74LS113A

## GUARANTEED OPERATING RANGES

| Symbol          | Parameter                           |          | Min         | Typ        | Max         | Unit |
|-----------------|-------------------------------------|----------|-------------|------------|-------------|------|
| V <sub>CC</sub> | Supply Voltage                      | 54<br>74 | 4.5<br>4.75 | 5.0<br>5.0 | 5.5<br>5.25 | V    |
| T <sub>A</sub>  | Operating Ambient Temperature Range | 54<br>74 | -55<br>0    | 25<br>25   | 125<br>70   | °C   |
| I <sub>OH</sub> | Output Current — High               | 54, 74   |             |            | -0.4        | mA   |
| I <sub>OL</sub> | Output Current — Low                | 54<br>74 |             |            | 4.0<br>8.0  | mA   |

## DC CHARACTERISTICS OVER OPERATING TEMPERATURE RANGE (unless otherwise specified)

| Symbol          | Parameter                      | Limits               |       |      | Unit              | Test Conditions  |   |
|-----------------|--------------------------------|----------------------|-------|------|-------------------|--|---|
|                 |                                | Min                  | Typ   | Max  |                   |  |   |
| V <sub>IH</sub> | Input HIGH Voltage             | 2.0                  |       |      | V                 | Guaranteed Input HIGH Voltage for All Inputs   |   |
| V <sub>IL</sub> | Input LOW Voltage              | 54                   |       | 0.7  | V                 | Guaranteed Input LOW Voltage for All Inputs  |   |
|                 |                                | 74                   |       | 0.8  |                   |  |   |
| V <sub>IK</sub> | Input Clamp Diode Voltage      |                      | -0.65 | -1.5 | V                 | V <sub>CC</sub> = MIN, I <sub>IN</sub> = -18 mA  |   |
| V <sub>OH</sub> | Output HIGH Voltage            | 54                   | 2.5   | 3.5  | V                 | V <sub>CC</sub> = MIN, I <sub>OH</sub> = MAX, V <sub>IN</sub> = V <sub>IH</sub> or V <sub>IL</sub> per Truth Table |   |
|                 |                                | 74                   | 2.7   | 3.5  | V                 |  |   |
| V <sub>OL</sub> | Output LOW Voltage             | 54, 74               |       | 0.25 | 0.4               | I <sub>OL</sub> = 4.0 mA   | V <sub>CC</sub> = V <sub>CC</sub> MIN, V <sub>IN</sub> = V <sub>IL</sub> or V <sub>IH</sub> per Truth Table |
|                 |                                | 74                   |       | 0.35 | 0.5               | I <sub>OL</sub> = 8.0 mA   |   |
| I <sub>IH</sub> | Input HIGH Current             | J, K<br>Set<br>Clock |       |      | 20<br>60<br>80    | μA   | V <sub>CC</sub> = MAX, V <sub>IN</sub> = 2.7 V  |
|                 |                                | J, K<br>Set<br>Clock |       |      | 0.1<br>0.3<br>0.4 | mA   | V <sub>CC</sub> = MAX, V <sub>IN</sub> = 7.0 V  |
| I <sub>IL</sub> | Input LOW Current              | J, K<br>Set, Clock   |       |      | -0.4<br>-0.8      | mA   | V <sub>CC</sub> = MAX, V <sub>IN</sub> = 0.4 V  |
| I <sub>OS</sub> | Short Circuit Current (Note 1) |                      | -20   |      | -100              | mA   | V <sub>CC</sub> = MAX   |
| I <sub>CC</sub> | Power Supply Current           |                      |       |      | 6.0               | mA   | V <sub>CC</sub> = MAX   |

Note 1: Not more than one output should be shorted at a time, nor for more than 1 second.

## AC CHARACTERISTICS (T<sub>A</sub> = 25°C, V<sub>CC</sub> = 5.0 V)

| Symbol           | Parameter                                 | Limits |     |     | Unit | Test Conditions                                   |
|------------------|---|--------|-----|-----|------|---|
|                  |   | Min    | Typ | Max |      |   |
| f <sub>MAX</sub> | Maximum Clock Frequency                   | 30     | 45  |     | MHz  | V <sub>CC</sub> = 5.0 V<br>C <sub>L</sub> = 15 pF |
| t <sub>PLH</sub> | Propagation Delay, Clock<br>Set to Output |        | 15  | 20  | ns   |   |
| t <sub>PHL</sub> |   |        | 15  | 20  | ns   |   |

## AC SETUP REQUIREMENTS (T<sub>A</sub> = 25°C, V<sub>CC</sub> = 5.0 V)

| Symbol         | Parameter              | Limits |     |     | Unit | Test Conditions         |
|----------------|------------------------|--------|-----|-----|------|-------------------------|
|                |                        | Min    | Typ | Max |      |                         |
| t <sub>W</sub> | Clock Pulse Width High | 20     |     |     | ns   | V <sub>CC</sub> = 5.0 V |
| t <sub>W</sub> | Set Pulse Width        | 25     |     |     | ns   |                         |
| t <sub>s</sub> | Setup Time             | 20     |     |     | ns   |                         |
| t <sub>h</sub> | Hold Time              | 0      |     |     | ns   |                         |

**Case 751A-02 D Suffix  
14-Pin Plastic  
SO-14**

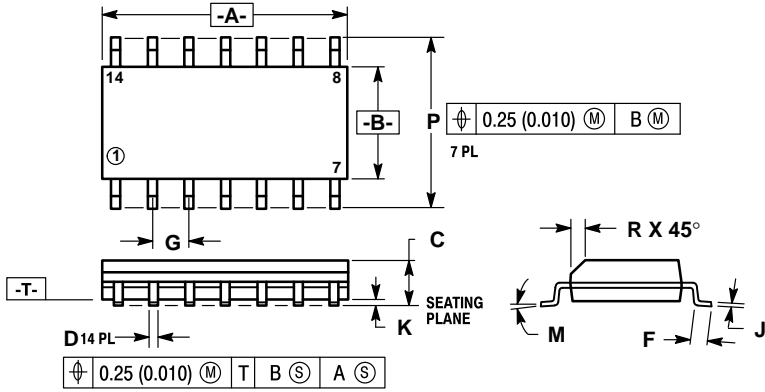

- NOTES:
1. DIMENSIONS "A" AND "B" ARE DATUMS AND "T" IS A DATUM SURFACE.
  2. DIMENSIONING AND TOLERANCING PER ANSI Y14.5M, 1982.
  3. CONTROLLING DIMENSION: MILLIMETER.
  4. DIMENSION A AND B DO NOT INCLUDE MOLD PROTRUSION.
  5. MAXIMUM MOLD PROTRUSION 0.15 (0.006) PER SIDE.
  6. 751A-01 IS OBSOLETE, NEW STANDARD 751A-02.

| DIM | MILLIMETERS |      | INCHES    |       |
|-----|-------------|------|-----------|-------|
|     | MIN         | MAX  | MIN       | MAX   |
| A   | 8.55        | 8.75 | 0.337     | 0.344 |
| B   | 3.80        | 4.00 | 0.150     | 0.157 |
| C   | 1.35        | 1.75 | 0.054     | 0.068 |
| D   | 0.35        | 0.49 | 0.014     | 0.019 |
| F   | 0.40        | 1.25 | 0.016     | 0.049 |
| G   | 1.27 BSC    |      | 0.050 BSC |       |
| J   | 0.19        | 0.25 | 0.008     | 0.009 |
| K   | 0.10        | 0.25 | 0.004     | 0.009 |
| M   | 0°          | 7°   | 0°        | 7°    |
| P   | 5.80        | 6.20 | 0.229     | 0.244 |
| R   | 0.25        | 0.50 | 0.010     | 0.019 |

**Case 632-08 J Suffix  
14-Pin Ceramic Dual In-Line**

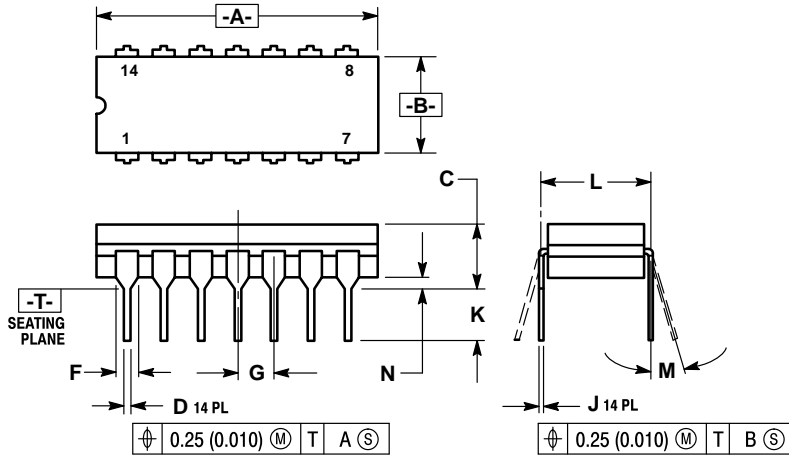

- NOTES:
1. DIMENSIONING AND TOLERANCING PER ANSI Y14.5M, 1982.
  2. CONTROLLING DIMENSION: INCH.
  3. DIMENSION L TO CENTER OF LEAD WHEN FORMED PARALLEL.
  4. DIM F MAY NARROW TO 0.76 (0.030) WHERE THE LEAD ENTERS THE CERAMIC BODY.
  5. 632-01 THRU -07 OBSOLETE, NEW STANDARD 632-08.

| DIM | MILLIMETERS |       | INCHES    |       |
|-----|-------------|-------|-----------|-------|
|     | MIN         | MAX   | MIN       | MAX   |
| A   | 19.05       | 19.94 | 0.750     | 0.785 |
| B   | 6.23        | 7.11  | 0.245     | 0.280 |
| C   | 3.94        | 5.08  | 0.155     | 0.200 |
| D   | 0.39        | 0.50  | 0.015     | 0.020 |
| F   | 1.40        | 1.65  | 0.055     | 0.065 |
| G   | 2.54 BSC    |       | 0.100 BSC |       |
| J   | 0.21        | 0.38  | 0.008     | 0.015 |
| K   | 3.18        | 4.31  | 0.125     | 0.170 |
| L   | 7.62 BSC    |       | 0.300 BSC |       |
| M   | 0°          | 15°   | 0°        | 15°   |
| N   | 0.51        | 1.01  | 0.020     | 0.040 |

**Case 646-06 N Suffix  
14-Pin Plastic**

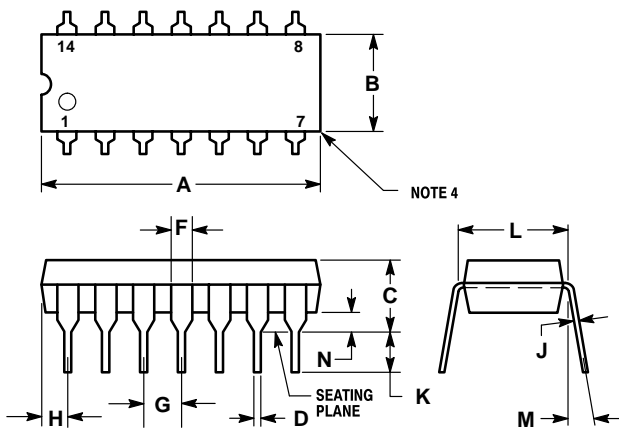

- NOTES:
1. LEADS WITHIN 0.13 mm (0.005) RADIUS OF TRUE POSITION AT SEATING PLANE AT MAXIMUM MATERIAL CONDITION.
  2. DIMENSION "L" TO CENTER OF LEADS WHEN FORMED PARALLEL.
  3. DIMENSION "B" DOES NOT INCLUDE MOLD FLASH.
  4. ROUNDED CORNERS OPTIONAL.
  5. 646-05 OBSOLETE, NEW STANDARD 646-06.

| DIM | MILLIMETERS |       | INCHES    |       |
|-----|-------------|-------|-----------|-------|
|     | MIN         | MAX   | MIN       | MAX   |
| A   | 18.16       | 19.56 | 0.715     | 0.770 |
| B   | 6.10        | 6.60  | 0.240     | 0.260 |
| C   | 3.69        | 4.69  | 0.145     | 0.185 |
| D   | 0.38        | 0.53  | 0.015     | 0.021 |
| F   | 1.02        | 1.78  | 0.040     | 0.070 |
| G   | 2.54 BSC    |       | 0.100 BSC |       |
| H   | 1.32        | 2.41  | 0.052     | 0.095 |
| J   | 0.20        | 0.38  | 0.008     | 0.015 |
| K   | 2.92        | 3.43  | 0.115     | 0.135 |
| L   | 7.62 BSC    |       | 0.300 BSC |       |
| M   | 0°          | 10°   | 0°        | 10°   |
| N   | 0.39        | 1.01  | 0.015     | 0.039 |

Motorola reserves the right to make changes without further notice to any products herein. Motorola makes no warranty, representation or guarantee regarding the suitability of its products for any particular purpose, nor does Motorola assume any liability arising out of the application or use of any product or circuit, and specifically disclaims any and all liability, including without limitation consequential or incidental damages. "Typical" parameters can and do vary in different applications. All operating parameters, including "Typicals" must be validated for each customer application by customer's technical experts. Motorola does not convey any license under its patent rights nor the rights of others. Motorola products are not designed, intended, or authorized for use as components in systems intended for surgical implant into the body, or other applications intended to support or sustain life, or for any other application in which the failure of the Motorola product could create a situation where personal injury or death may occur. Should Buyer purchase or use Motorola products for any such unintended or unauthorized application, Buyer shall indemnify and hold Motorola and its officers, employees, subsidiaries, affiliates, and distributors harmless against all claims, costs, damages, and expenses, and reasonable attorney fees arising out of, directly or indirectly, any claim of personal injury or death associated with such unintended or unauthorized use, even if such claim alleges that Motorola was negligent regarding the design or manufacture of the part. Motorola and  are registered trademarks of Motorola, Inc. Motorola, Inc. is an Equal Opportunity/Affirmative Action Employer.

**Literature Distribution Centers:**

USA: Motorola Literature Distribution; P.O. Box 20912; Phoenix, Arizona 85036.

EUROPE: Motorola Ltd.; European Literature Centre; 88 Tanners Drive, Blakelands, Milton Keynes, MK14 5BP, England.

JAPAN: Nippon Motorola Ltd.; 4-32-1, Nishi-Gotanda, Shinagawa-ku, Tokyo 141, Japan.

ASIA PACIFIC: Motorola Semiconductors H.K. Ltd.; Silicon Harbour Center, No. 2 Dai King Street, Tai Po Industrial Estate, Tai Po, N.T., Hong Kong.

