

CMOS 8-Bit Microcontroller

TMP87C408M, TMP87C408N, TMP87C808M, TMP87C808N TMP87C408LM, TMP87C408LN, TMP87C808LM, TMP87C808LN TMP87C408DM

TMP87C408/808/408L/808L is high speed and high performance 8-bit single chip microcomputers to operate on low voltage and low power consumption. This MCU contains ROM, RAM, input/output ports, multi-function timer/counter, a serial interface, and 8-bit A/D converter.

Part No.	ROM	RAM	Package	OTP MCU	Operation Voltage Range
TMP87C408M	4K × 8-bit	256 × 8-bit	P-SOP28-450-1.27	TMP87P808M	2.7 V to 5.5 V at 4.2 MHz
TMP87C408N			P-SDIP28-400-1.78	TMP87P808N	
TMP87C408DM			P-SSQP30-56-0.65		
TMP87C808M	8K × 8-bit		P-SOP28-450-1.27	TMP87P808M	1.8 V to 4.0 V at 4.2 MHz
TMP87C808N			P-SDIP28-400-1.78	TMP87P808N	
TMP87C408LM	4K × 8-bit		P-SOP28-450-1.27	TMP87P808LM	
TMP87C408LN		P-SDIP28-400-1.78	TMP87P808LN		
TMP87C808LM	8K × 8-bit	P-SOP28-450-1.27	TMP87P808LM		
TMP87C808LN		P-SDIP28-400-1.78	TMP87P808LN		

Features

- ◆ 8-bit single chip microcomputer TLCS-870 series
- ◆ Minimum instruction execution time: 0.5 μ s (at 8 MHz)
(TMP87C408/C808/P808)
0.95 μ s (at 4.2 MHz)
(TMP87C408L/C808L/P808L)
- ◆ 129 types & 412 basic instructions
 - Multiplication (8 bits × 8 bits, 16 bits ÷ 8 bits)
: Execution time 3.5 μ s (at 8 MHz)
(TMP87C408/C808/P808)
7.0 μ s (at 4 MHz)
(TMP87C408L/C808L/P808L)
 - Bit manipulations
(Set / Clear / Complement / Load / Store / Test / Exclusive or)
 - 16-bit data operations
 - 1-byte jump / call (Short relative jump / Vector call)

P-SOP28-450-1.27

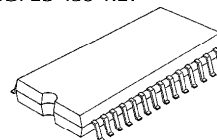

TMP87C408M
 TMP87C408LM
 TMP87C808M
 TMP87C808LM
 TMP87P808M
 TMP87P808LM

P-SDIP28-400-1.78

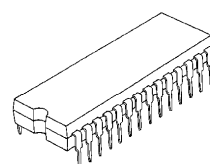

TMP87C408N
 TMP87C408LN
 TMP87C808N
 TMP87C808LN
 TMP87P808N
 TMP87P808LN

P-SSQP30-56-0.65

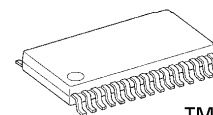

TMP87C408DM

000707EBP1

- For a discussion of how the reliability of microcontrollers can be predicted, please refer to Section 1.3 of the chapter entitled Quality and Reliability Assurance / Handling Precautions.
- TOSHIBA is continually working to improve the quality and reliability of its products. Nevertheless, semiconductor devices in general can malfunction or fail due to their inherent electrical sensitivity and vulnerability to physical stress. It is the responsibility of the buyer, when utilizing TOSHIBA products, to comply with the standards of safety in making a safe design for the entire system, and to avoid situations in which a malfunction or failure of such TOSHIBA products could cause loss of human life, bodily injury or damage to property. In developing your designs, please ensure that TOSHIBA products are used within specified operating ranges as set forth in the most recent TOSHIBA products specifications. Also, please keep in mind the precautions and conditions set forth in the "Handling Guide for Semiconductor Devices," or "TOSHIBA Semiconductor Reliability Handbook" etc..
- The TOSHIBA products listed in this document are intended for usage in general electronics applications (computer, personal equipment, office equipment, measuring equipment, industrial robotics, domestic appliances, etc.). These TOSHIBA products are neither intended nor warranted for usage in equipment that requires extraordinarily high quality and/or reliability or a malfunction or failure of which may cause loss of human life or bodily injury ("Unintended Usage"). Unintended Usage include atomic energy control instruments, airplane or spaceship instruments, transportation instruments, traffic signal instruments, combustion control instruments, medical instruments, all types of safety devices, etc.. Unintended Usage of TOSHIBA products listed in this document shall be made at the customer's own risk.
- The products described in this document are subject to the foreign exchange and foreign trade laws.
- The information contained herein is presented only as a guide for the applications of our products. No responsibility is assumed by TOSHIBA CORPORATION for any infringements of intellectual property or other rights of the third parties which may result from its use. No license is granted by implication or otherwise under any intellectual property or other rights of TOSHIBA CORPORATION or others.
- The information contained herein is subject to change without notice.

- ◆ 10 interrupt sources (External: 4, Internal: 6)
 - All sources have independent latches each, and nested interrupt control is available.
 - Edge-selectable external interrupts with noise reject
 - High-speed task switching by register bank changeover
- ◆ Input / Output ports (22 pins)
 - Middle current output: 6 pins (Typ. 7 mA)
(TMP87C408/C808/P808)
(Typ. 6 mA)
(TMP87C408L/C808L/P808L)
- ◆ Two 16-bit Timer/Counters
 - Timer, Eventcounter, Programmable pulse generator output, Pulse width measurement, External trigger timer, Window modes
- ◆ Time Base Timer
 - Interrupt frequency types: 8 types (1 to 16384 Hz)
- ◆ Divider output function (frequency: 4 types)
- ◆ Watchdog Timer
- ◆ One 8-bit Serial Interface
 - With 8 bytes transmit/receive data buffer
 - Internal / external serial clock, and 4/8-bit mode
- ◆ 8-bit Successive approximate type A/D converter with sample and hold
 - 6 analog inputs
 - Conversion time: 23 μ s / 92 μ s at 8 MHz programmable selectable (TMP87C408/C808/P808)
46 μ s / 184 μ s at 4 MHz programmable selectable (TMP87C408L/C808L/P808L)
- ◆ Two Power saving operating modes
 - STOP mode: Oscillation stops. Battery/Capacitor back-up
Port output hold/high-impedance
 - IDLE mode : CPU stops, and Peripherals operate using high-frequency clock. Release by interrupts.
- ◆ Operating voltage : 2.7 to 5.5 V at 4.2 MHz/4.5 to 5.5 V at 8 MHz (TMP87C408/C808/P808)
1.8 to 4.0 V at 4.2 MHz (TMP87C408L/C808L/P808L)
- ◆ Emulation pod : BM87C408M0A

Pin Assignments (Top View)

P-SOP28-450-1.27 / P-SDIP28-400-1.78

P-SOP30-56-0.65

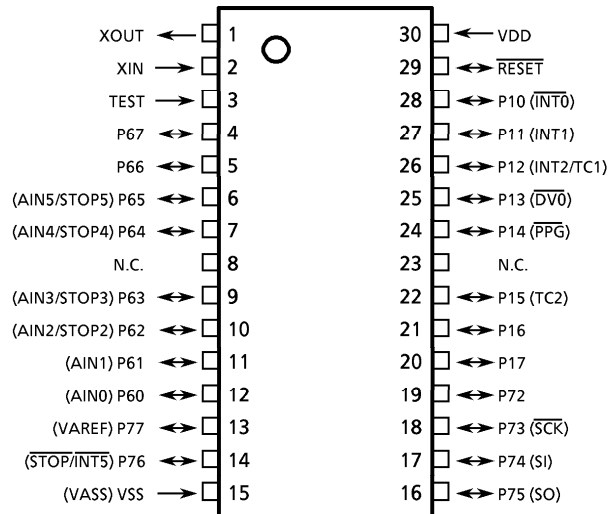
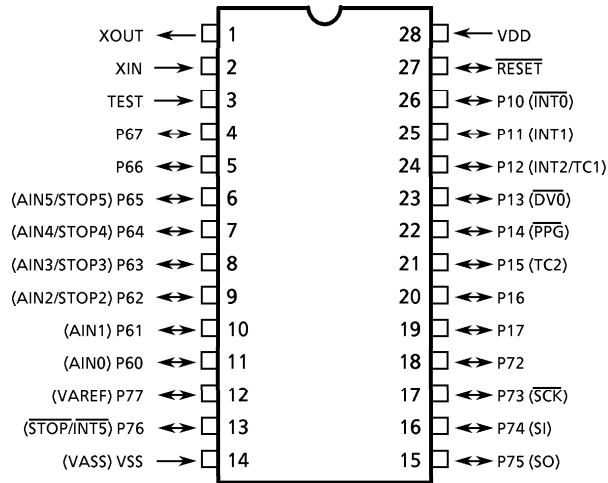

Block Diagram

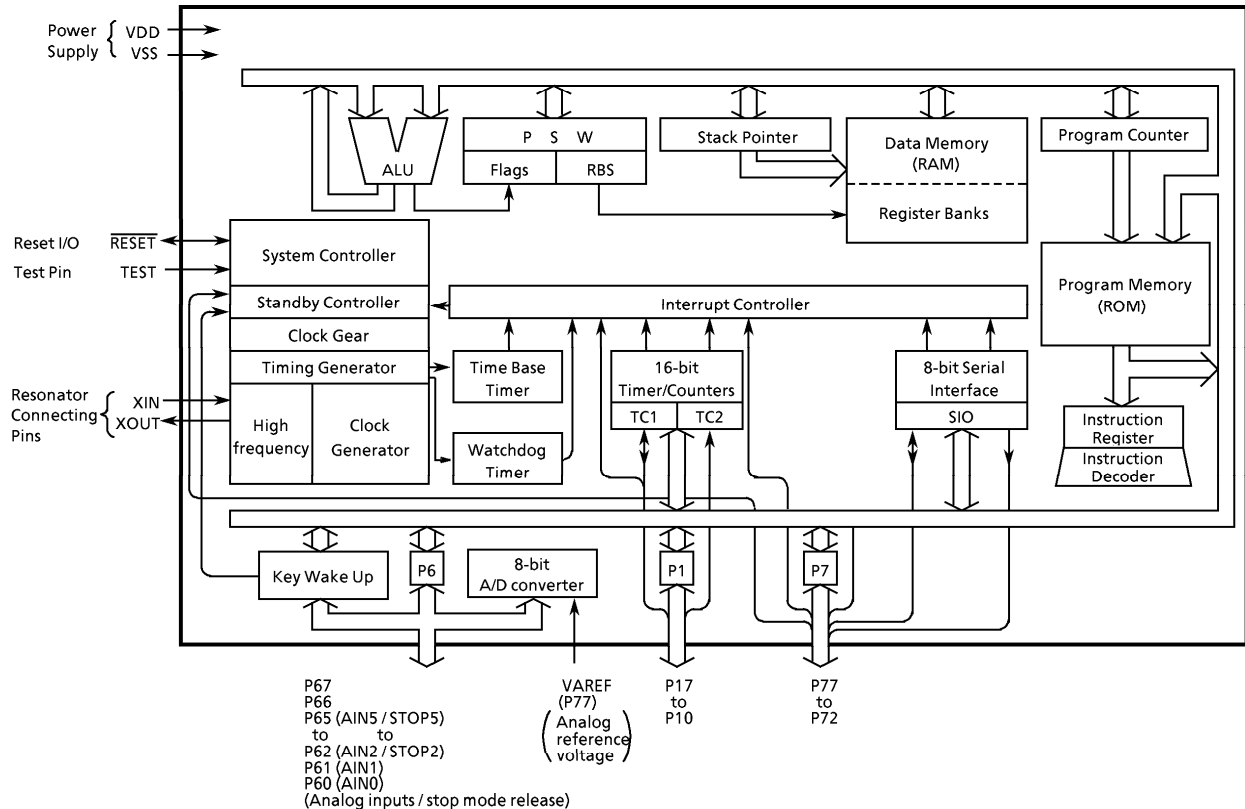

Pin Function

Pin Name	Input / Output	Function		
P17, P16	I/O	8-bit programmable input/output ports (tri-states)		
P15 (TC2)	I/O (Input)	Each bit of these ports can be individually configured as an input or an output under software control. When used as an external interrupt input or a timer counter input, the input mode is configured. When used as a divider output or a PPG output, the latch must be set to "1" and the output mode is configured.		
P14 ($\overline{\text{PPG}}$)	I/O (Output)	Timer/Counter 2 input		
P13 ($\overline{\text{DVO}}$)		Programmable pulse generator output		
P12 (INT2 / TC1)	I/O (Input)	Divider output		
P11 (INT1)		External interrupt input 2 or Timer/Counter 1 input		
P10 (INT0)		External interrupt input 1		
P67, P66	I/O (Input)	8-bit programmable input/output port (tri-states). Each bit of the port can be individually configured as an input or an output under software control. When used as an analog input or stop mode release input, the input mode is configured.		
P65 (AIN5 / STOP5)		A/D converter analog inputs	Stop mode release inputs	
P64 (AIN4 / STOP4)		A/D converter analog inputs		
P63 (AIN3 / STOP3)				
P62 (AIN2 / STOP2)				
P61 (AIN1)				
P60 (AIN0)				
P77 (VAREF)	I/O (Output)	6-bit programmable input/output port (tri-states). Analog reference power supply		
P76 ($\overline{\text{STOP}}/\text{INT5}$)	I/O (Output)	Each bit of these ports can be individually configured as an input or an output under software control. STOP mode release input/External interrupt 5 input		
P75 (SO)		SIO serial data output		
P74 (SI)	I/O (Input)	When used as an external interrupt input or a serial interface input pin, the input mode is configured. SIO serial data input		
P73 ($\overline{\text{SCK}}$)	I/O (I/O)	SIO serial clock input/output		
P72	I/O	When used as a serial interface output pin, the latch must be set to "1" and the output mode is configured.		
XIN, XOUT	Input, Output	Resonator connecting pins for clock. For inputting external clock, XIN is used and XOUT is opened.		
$\overline{\text{RESET}}$	I/O	Reset signal input or watchdog timer output/address-trap-reset output/system-clock-reset output.		
TEST	Input	Test pin for outgoing test. Be tied to low.		
VDD	Power Supply	2.7 to 5.5 V (TMP87C408/C808/P808), 1.8 to 4.0 V (TMP87C408L/C808L/P808L)		
VSS (VASS)		0 V (GND)	Analog reference GND	

Operational Description

1. CPU Core Functions

The CPU core consists of a CPU, a system clock controller, an interrupt controller, and a watchdog timer. This section provides a description of the CPU core, the program memory, the data memory, and the reset circuit.

1.1 Memory Address Map

The TLCS-870 Series is capable of addressing 64 Kbytes of memory. Figure 1-1 shows the memory address maps of the 87C408/808/408L/808L. In the TLCS-870 Series, the memory is organized 4 address spaces (ROM, RAM, SFR, and DBR). It uses a memory mapped I/O system, and all I/O registers are mapped in the SFR/DBR address spaces. There are 16 banks of general-purpose registers. The register banks are also assigned to the RAM address space.

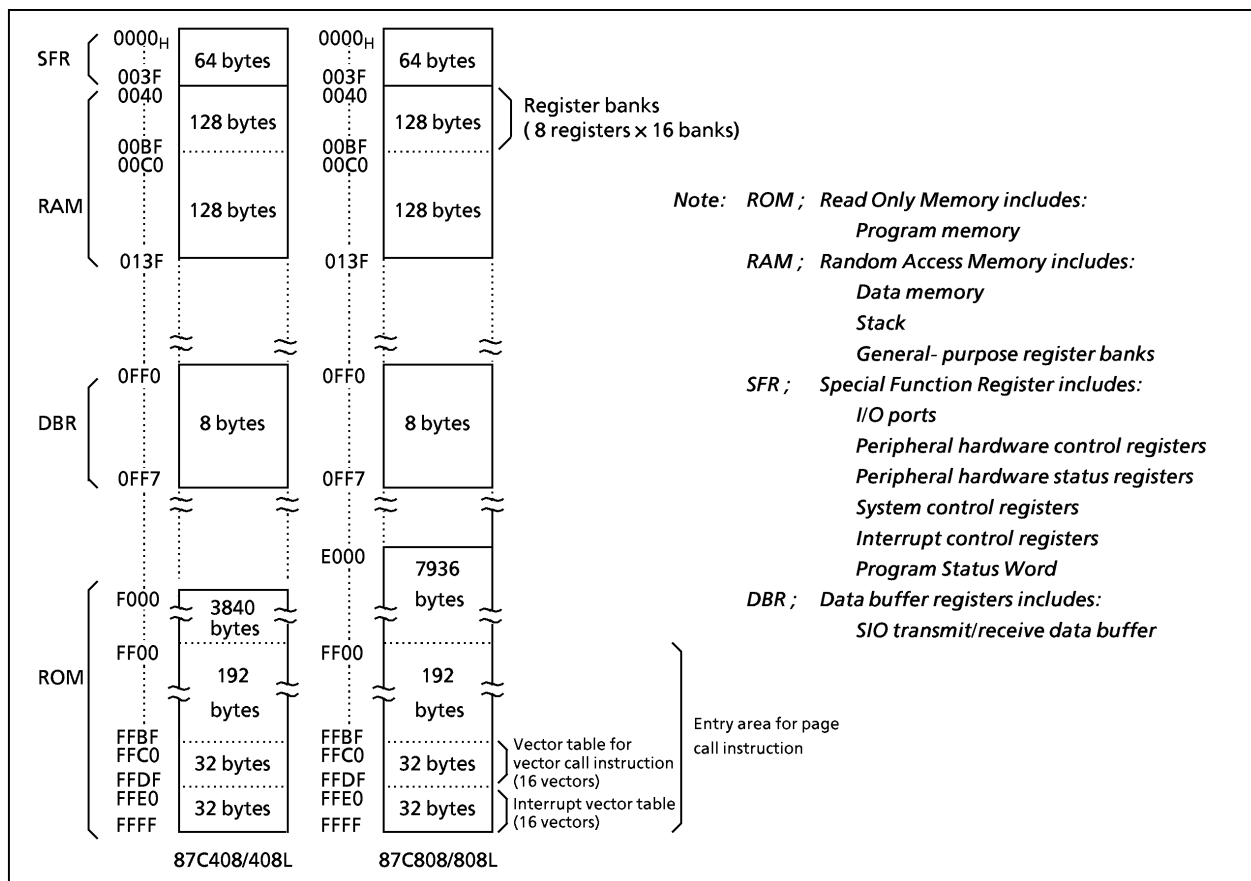

Figure 1-1. Memory Address Map

Electrical Characteristics

(1) 87C408/808

Absolute Maximum Ratings

 $(V_{SS} = 0\text{ V})$

Parameter	Symbol	Conditions	Ratings	Unit	
Supply Voltage	V_{DD}		- 0.3 to 6.5	V	
Input Voltage	V_{IN}		- 0.3 to $V_{DD} + 0.3$	V	
Output Voltage	V_{OUT}		- 0.3 to $V_{DD} + 0.3$	V	
Output Current (Per 1 pin)	IOL	I_{OUT1}	P1, P6	3.2	mA
		I_{OUT2}	P7 (Middle current port)	15	mA
	IOH	I_{OUT3}	P1, P6, P7	- 1.8	mA
Output Current (Total)	IOL	ΣI_{OUT1}	P1, P6	50	mA
		ΣI_{OUT2}	P7 (Middle current port)	60	mA
	IOH	ΣI_{OUT3}	P1, P6, P7	30	mA
Power Dissipation [$T_{opr} = 70^\circ\text{C}$]	PD		SDIP	300	mW
			SOP	180	
Input Current	I_{IN1}	P1, P6, P7		1.0	mA
	I_{IN2}			- 1.0	
Soldering Temperature (time)	T_{sld}		260 (10 s)	$^\circ\text{C}$	
Storage Temperature	T_{stg}		- 55 to 125	$^\circ\text{C}$	
Operating Temperature	T_{opr}		- 30 to 70	$^\circ\text{C}$	

Note: The absolute maximum ratings are rated values which must not be exceeded during operation, even for an instant. Any one of the ratings must not be exceeded. If any absolute maximum rating is exceeded, a device may break down or its performance may be degraded, causing it to catch fire or explode resulting in injury to the user. Thus, when designing products which include this device, ensure that no absolute maximum rating value will ever be exceeded.

Recommended Operating Conditions

 $(V_{SS} = 0\text{ V}, T_{opr} = -30\text{ to }70^\circ\text{C})$

Parameter	Symbol	Pins	Conditions	Min	Max	Unit	
Supply Voltage	V_{DD}		$f_c = 8\text{ MHz}$	NORMAL mode	4.5	5.5	V
				IDLE mode			
			$f_c = 4.2\text{ MHz}$	NORMAL mode	2.7		
				IDLE mode			
		STOP mode	2.0				
Input High Voltage	V_{IH1}	Except hysteresis input	$V_{DD} \geq 4.5\text{ V}$	$V_{DD} \times 0.70$	V_{DD}	V	
	V_{IH2}	Hysteresis input		$V_{DD} \times 0.75$			
	V_{IH3}			$2.7\text{ V} \leq V_{DD} < 4.5\text{ V}$			$V_{DD} \times 0.90$
Input Low Voltage	V_{IL1}	Except hysteresis input	$V_{DD} \geq 4.5\text{ V}$		$V_{DD} \times 0.30$	V	
	V_{IL2}	Hysteresis input			$V_{DD} \times 0.25$		
	V_{IL3}			$2.7\text{ V} \leq V_{DD} < 4.5\text{ V}$			$V_{DD} \times 0.10$
Clock Frequency	f_c	XIN, XOUT	$V_{DD} = 4.5\text{ to }5.5\text{ V}$	1.0	8.0	MHz	
			$V_{DD} = 2.7\text{ to }5.5\text{ V}$		4.2		

Note 1: The recommended operating conditions for a device are operating conditions under which it can be guaranteed that the device will operate as specified. If the device is used under operating conditions other than the recommended operating conditions (supply voltage, operating temperature range, specified AC/DC values etc.), malfunction may occur. Thus, when designing products which include this device, ensure that the recommended operating conditions for the device are always adhered to.

Note 2: Clock frequency f_c : Supply voltage range is specified in NORMAL mode and IDLE mode.

Note 3: Minimum of clock frequency: $1\text{ MHz} \leq f_{c\text{gck}}$

D.C. Characteristics

(V_{SS} = 0 V, T_{opr} = -30 to 70°C)

Parameter	Symbol	Pins	Conditions	Min	Typ.	Max	Unit		
Hysteresis Voltage	V _{HS}	Hysteresis inputs		-	0.9	-	V		
Input Current	I _{IN1}	TEST	V _{DD} = 5.5 V V _{IN} = 5.5 V / 0 V	-2	-	2	μA		
	I _{IN2}	Tri-state ports							
	I _{IN3}	RESET, STO _{Pi}							
Input Resistance	R _{IN1}	TEST		30	70	150	kΩ		
	R _{IN2}	RESET		100	220	450			
	R _{IN3}	STO _{Pi}	i = 2 to 5	30	70	150			
Output Leak Current	I _{LO}	Tri-state ports	V _{DD} = 5.5 V, V _{OUT} = 5.5 V / 0 V	-2	-	2	μA		
Output High Voltage	V _{OH2}	Tri-state ports	V _{DD} = 4.5 V, I _{OH} = -0.7 mA	4.1	-	-	V		
Output Low Voltage	V _{OL}	Except XOUT and P7	V _{DD} = 4.5 V, I _{OL} = 1.6 mA	-	-	0.4	V		
Output Low Current	I _{OL3}	P7	V _{DD} = 4.5 V, V _{OL} = 1.0 V	-	7	-	mA		
Supply Current in NORMAL mode	I _{DD}		V _{DD} = 5.5 V f _c = 8 MHz V _{IN} = 5.3 V / 0.2 V	fcgck	fc	-	6.5	10	mA
Supply Current in IDLE mode					fc/2	-	4.0	6.4	
					fc/4	-	2.6	4.7	
				fc/8	-	1.9	3.9		
Supply Current in NORMAL mode				fcgck	fc	-	3.3	5.0	
					fc/2	-	2.4	3.9	
			fc/4		-	1.9	3.5		
Supply Current in IDLE mode			fcgck	fc/8	-	1.6	3.3		
				fc	-	1.5	2.5		
				fc/2	-	0.85	1.6		
Supply Current in STOP mode			fcgck	fc/4	-	0.6	1.2		
				fc	-	0.8	1.4		
Supply Current in STOP mode			fcgck	fc/2	-	0.55	1.1		
	fc/4	-		0.45	0.9				
Supply Current in STOP mode			V _{DD} = 5.5 V V _{IN} = 5.3 V / 0.2 V	-	0.5	10	μA		

Note 1: Typical values show those at T_{opr} = 25°C, V_{DD} = 5 V.

Note 2: Input Current I_{IN1}, I_{IN3}: The current through resistor is not included, when the input resistor (pull-up or pull-down) is contained.

Note 3: I_{DD}; Except for I_{REF}

A/D Conversion Characteristics

 $(V_{SS} = 0\text{ V}, V_{DD} = 2.7\text{ to }5.5\text{ V}, T_{opr} = -30\text{ to }70^{\circ}\text{C})$

Parameter	Symbol	Conditions	Min	Typ.	Max	Unit
Analog Reference Voltage	V_{AREF}		2.7	–	V_{DD}	V
	V_{ASS}		V_{SS}			
Analog Input Voltage Range	V_{AIN}		V_{ASS}	–	V_{AREF}	V
Analog Reference Current	I_{REF}	$V_{AREF} = 5.5\text{ V}, V_{ASS} (V_{SS}) = 0.0\text{ V}$	–	0.8	1.0	mA
Nonlinearity Error		$V_{DD} = 5.0\text{ V}$ $V_{AREF} = 5.000\text{ V}$ $V_{ASS} (V_{SS}) = 0.000\text{ V}$ or $V_{DD} = 2.7\text{ V}$ $V_{AREF} = 2.700\text{ V}$ $V_{ASS} (V_{SS}) = 0.000\text{ V}$	–	–	± 1	LSB
Zero Point Error			–	–	± 1	
Full Scale Error			–	–	± 1	
Total Error			–	–	± 2	

Note: Quantizing error is not contained in those errors.

TMP87C408DM

Parameter	Symbol	Conditions	Min	Typ.	Max	Unit
Nonlinearity Error		$V_{DD} = 2.7\text{ V}$ $V_{AREF} = 2.700\text{ V}$ $V_{ASS} (V_{SS}) = 0.000\text{ V}$	–	–	± 1	LSB
Zero Point Error			–	–	± 3	
Full Scale Error			–	–	± 3	
Total Error			–	–	± 4	

Note: For the TMP87C408, the guaranteed value for A/D conversion accuracy is different when $V_{DD} = 2.7\text{ V}$.

A.C. Characteristics (I)

(V_{SS} = 0 V, V_{DD} = 4.5 to 5.5 V, T_{opr} = - 30 to 70°C)

Parameter	Symbol	Conditions	Min	Typ.	Max	Unit
Machine Cycle Time	t _{cy}	In NORMAL mode	0.5	-	4	μs
		In IDLE mode				
High Level Clock Pulse Width	t _{WCH}	For external clock operation fc = 8 MHz (XIN input)	50	-	-	ns
Low Level Clock Pulse Width	t _{WCL}					
A/D Conversion Time	t _{ADC}	ACK = 0	-	46	-	t _{cy}
		ACK = 1		184		
A/D Sampling Time	t _{AIN}		-	4		

A.C. Characteristics (II)

(V_{SS} = 0 V, V_{DD} = 2.7 to 5.5 V, T_{opr} = - 30 to 70°C)

Parameter	Symbol	Conditions	Min	Typ.	Max	Unit
Machine Cycle Time	t _{cy}	In NORMAL mode	0.95	-	4	μs
		In IDLE mode				
High Level Clock Pulse Width	t _{WCH}	For external clock operation fc = 4.2 MHz	110	-	-	ns
Low Level Clock Pulse Width	t _{WCL}					
A/D Conversion Time	t _{ADC}	ACK = 0	-	46	-	t _{cy}
		ACK = 1		184		
A/D Sampling Time	t _{AIN}		-	4		

Note: A/D conversion timing:
Internal circuit for AIN0 to 5

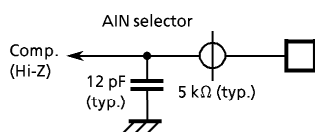

※ To keep the same level of an analog input during t_{AIN} is necessary for charging the electron to the sample hold circuit.

A/D conversion timing

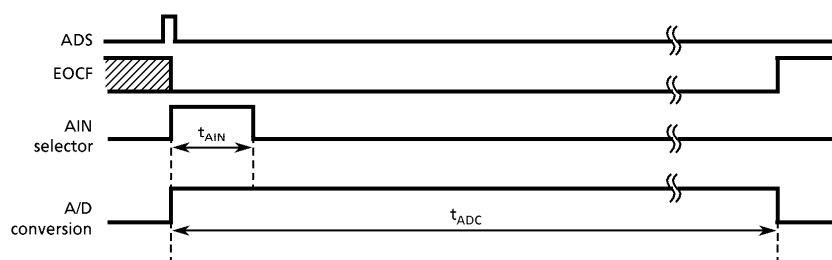

Recommended Oscillating Conditions (I)			(V _{SS} = 0 V, V _{DD} = 4.5 to 5.5 V, Topr = - 30 to 70°C)			
Parameter	Oscillator	Oscillation Frequency	Recommended Oscillator	Recommended Conditions		
				C ₁	C ₂	
High-frequency Oscillation	Ceramic Resonator	8 MHz (VDD = 4.5 to 5.5 V)	KYOCERA KBR8.0M	30 pF	30 pF	
			MURATA CSAC8.00MT	30 pF	30 pF	
			MURATA CSA8.00MTZ CST8.00MTW CST58.00MT	—	—	
	Crystal Oscillator	4.19 MHz (VDD = 2.7 to 5.5 V)	MURATA CSA4.19MG	30 pF	30 pF	
			MURATA CST4.19MGW	—	—	
			KYOCERA KBR4.0MS	30 pF	30 pF	
Crystal Oscillator	8 MHz (VDD = 4.5 to 5.5 V)	TOYOCOM 210B 8.0000	20 pF	20 pF		
		4 MHz (VDD = 2.7 to 5.5 V)			TOYOCOM 204B 4.000	

Recommended Oscillating Conditions (II)			(V _{SS} = 0 V, V _{DD} = 2.7 to 5.5 V, Topr = - 30 to 70°C)			
Parameter	Oscillator	Oscillation Frequency	Recommended Oscillator	Recommended Conditions		
				C ₁	C ₂	
High-frequency Oscillation	Ceramic Resonator	4.19 MHz (VDD = 2.7 to 5.5 V)	MURATA CSA4.19MG	30 pF	30 pF	
			MURATA CST4.19MGW	—	—	
			MURATA CSA4.00MG CSA4.00MGC	30 pF	30 pF	
		4 MHz (VDD = 2.7 to 5.5 V)	MURATA CST4.00MGW CSTC4.00MG	—	—	
			MURATA CSTCS4.00MG	—	—	

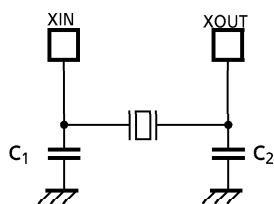

(1) High-frequency Oscillation

Note: When used in high electric field such as a picture tube, the package is recommended to be electrically shielded to maintain a regular operation.

Electrical Characteristics

(1) 87C408L/808L

Absolute Maximum Ratings

 $(V_{SS} = 0\text{ V})$

Parameter	Symbol	Conditions	Ratings	Unit	
Supply Voltage	V_{DD}		- 0.3 to 5.5	V	
Input Voltage	V_{IN}		- 0.3 to $V_{DD} + 0.3$	V	
Output Voltage	V_{OUT}		- 0.3 to $V_{DD} + 0.3$	V	
Output Current (Per 1 pin)	IOL	I_{OUT1}	P1, P6	3.2	mA
		I_{OUT2}	P7 (Middle current port)	15	mA
	IOH	I_{OUT3}	P1, P6, P7	- 1.8	mA
Output Current (Total)	IOL	ΣI_{OUT1}	P1, P6	50	mA
		ΣI_{OUT2}	P7 (Middle current port)	60	mA
	IOH	ΣI_{OUT3}	P1, P6, P7	30	mA
Power Dissipation [Topr = 70°C]	PD		SDIP	300	mW
			SOP	180	
Input Current	I_{IN1}	P1, P6, P7		1.0	mA
	I_{IN2}			- 1.0	
Soldering Temperature (time)	Tsld		260 (10 s)	°C	
Storage Temperature	Tstg		- 55 to 125	°C	
Operating Temperature	Topr		- 30 to 70	°C	

Note: The absolute maximum ratings are rated values which must not be exceeded during operation, even for an instant. Any one of the ratings must not be exceeded. If any absolute maximum rating is exceeded, a device may break down or its performance may be degraded, causing it to catch fire or explode resulting in injury to the user. Thus, when designing products which include this device, ensure that no absolute maximum rating value will ever be exceeded.

Recommended Operating Conditions

 $(V_{SS} = 0\text{ V}, \text{Topr} = -30\text{ to }70^\circ\text{C})$

Parameter	Symbol	Pins	Conditions	Min	Max	Unit	
Supply Voltage	V_{DD}		$f_c = 4.2\text{ MHz}$	NORMAL mode	1.8	4.0	V
				IDLE mode			
				STOP mode			
Input High Voltage	V_{IH}			$V_{DD} \times 0.90$	V_{DD}	V	
Input Low Voltage	V_{IL}			0	$V_{DD} \times 0.10$	V	
Clock Frequency	f_c	XIN, XOUT	$V_{DD} = 1.8\text{ to }4.0\text{ V}$	1.0	4.2	MHz	

Note 1: The recommended operating conditions for a device are operating conditions under which it can be guaranteed that the device will operate as specified. If the device is used under operating conditions other than the recommended operating conditions (supply voltage, operating temperature range, specified AC/DC values etc.), malfunction may occur. Thus, when designing products which include this device, ensure that the recommended operating conditions for the device are always adhered to.

Note 2: Clock frequency f_c : Supply voltage range is specified in NORMAL mode and IDLE mode.

Note 3: Minimum of clock frequency: $1\text{ MHz} \leq f_{cgck}$

D.C. Characteristics

(V_{SS} = 0 V, T_{opr} = -30 to 70°C)

Parameter	Symbol	Pins	Conditions	Min	Typ.	Max	Unit			
Hysteresis Voltage	V _{HS}	Hysteresis inputs		-	0.9	-	V			
Input Current	I _{IN1}	TEST	V _{DD} = 4.0 V V _{IN} = 4.0 V / 0 V	-2	-	2	μA			
	I _{IN2}	Tri-state ports								
	I _{IN3}	RESET, STOP								
Input Resistance	R _{IN1}	TEST		30	70	150	kΩ			
	R _{IN2}	RESET		100	220	450				
	R _{IN3}	STOP _i	i = 2 to 5	30	130	150				
Output Leak Current	I _{LO}	Tri-state ports	V _{DD} = 4.0 V, V _{OUT} = 4.0 V / 0 V	-2	-	2	μA			
Output High Voltage	V _{OH2}	Tri-state ports	V _{DD} = 4.0 V, I _{OH} = -0.5 mA	3.6	-	-	V			
Output Low Voltage	V _{OL}	Except XOUT and P7	V _{DD} = 4.0 V, I _{OL} = 1.3 mA	-	-	0.4	V			
Output Low Current	I _{OL3}	P7	V _{DD} = 4.0 V, V _{OL} = 1.0 V	-	6	-	mA			
Supply Current in NORMAL mode	I _{DD}			fcgck	fc	-	2.25	3.6	mA	
Supply Current in IDLE mode					fcgck	fc/2	-	1.35		2.5
						fc/4	-	0.9		1.9
						fc	-	1.2		1.9
Supply Current in NORMAL mode					fcgck	fc/2	-	0.9		1.7
						fc/4	-	0.7		1.5
						fc	-	1.5		2.5
Supply Current in IDLE mode					fcgck	fc/2	-	0.85		1.6
						fc/4	-	0.6		1.2
				fc		-	0.8	1.4		
Supply Current in NORMAL mode				fcgck	fc/2	-	0.55	1.1		
					fc/4	-	0.45	0.9		
					fc	-	0.9	1.3		
Supply Current in IDLE mode				fcgck	fc/2	-	0.5	0.8		
					fc/4	-	0.3	0.45		
					fc	-	0.35	0.5		
Supply Current in STOP mode				fcgck	fc/2	-	0.23	0.35		
					fc/4	-	0.17	0.26		
	V _{DD} = 5.5 V V _{IN} = 5.3 V / 0.2 V	-	0.5			μA				

Note 1: Typical values show those at T_{opr} = 25°C, V_{DD} = 4 V.

Note 2: Input Current I_{IN1}, I_{IN3}: The current through resistor is not included, when the input resistor (pull-up or pull-down) is contained.

Note 3: I_{DD}; Except for I_{REF}

A/D Conversion Characteristics (I)

 $(V_{SS} = 0V, V_{DD} = 1.8 \text{ to } 4.0V, T_{opr} = -30 \text{ to } 70^{\circ}\text{C})$

Parameter	Symbol	Conditions	Min	Typ.	Max	Unit
Analog Reference Voltage	V_{AREF}		1.8	-	V_{DD}	V
	V_{ASS}		V_{SS}			
Analog Input Voltage Range	V_{AIN}		V_{ASS}	-	V_{AREF}	V
Nonlinearity Error		$1.8V \leq V_{AREF} < 2.7V$ $V_{AREF} \leq V_{DD} \leq 4.0$ $V_{ASS} (V_{SS}) = 0.000V$ ACK = 1 (Note2)	-	-	± 2	LSB
Zero Point Error			-	-	± 2	
Full Scale Error			-	-	± 2	
Total Error			-	-	± 4	

Note1: Quantizing error is not contained in those errors.

Note2: ACK ; bit5 of ADCCR (#000E_H) . conversion time = 184 tcy (175.6 μ s / at f_{cgck} = 4.19 MHz)

A/D Conversion Characteristics (II)

 $(V_{SS} = 0V, V_{DD} = 2.7 \text{ to } 4.0V, T_{opr} = -30 \text{ to } 70^{\circ}\text{C})$

Parameter	Symbol	Conditions	Min	Typ.	Max	Unit
Analog Reference Voltage	V_{AREF}		2.7	-	V_{DD}	V
	V_{ASS}		V_{SS}			
Analog Input Voltage Range	V_{AIN}		V_{ASS}	-	V_{AREF}	V
Analog Reference Current	I_{REF}	$V_{AREF} = 4.0V, V_{ASS} (V_{SS}) = 0.0V$	-	0.5	1.0	mA
Nonlinearity Error		$V_{DD} = 4.0V$ $V_{AREF} = 4.000V$ $V_{ASS} (V_{SS}) = 0.000V$ or $V_{DD} = 2.7V$ $V_{AREF} = 2.700V$ $V_{ASS} (V_{SS}) = 0.000V$	-	-	± 1	LSB
Zero Point Error			-	-	± 1	
Full Scale Error			-	-	± 1	
Total Error			-	-	± 2	

Note: Quantizing error is not contained in those errors.

A.C. Characteristics

($V_{SS} = 0\text{ V}$, $V_{DD} = 1.8\text{ to }4.0\text{ V}$, $T_{opr} = -30\text{ to }70^\circ\text{C}$)

Parameter	Symbol	Conditions	Min	Typ.	Max	Unit
Machine Cycle Time	t _{cy}	In NORMAL mode	0.95	-	4	μs
		In IDLE mode				
High Level Clock Pulse Width	t _{WCH}	For external clock operation f _c = 4.2 MHz	110	-	-	ns
Low Level Clock Pulse Width	t _{WCL}					
A/D Conversion Time	t _{ADC}	ACK = 0	-	46	-	t _{cy}
		ACK = 1		184		
A/D Sampling Time	t _{AIN}		-	4		

Note: A/D conversion timing:
Internal circuit for AIN0 to 5

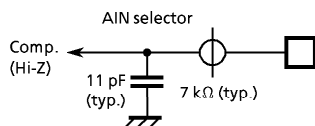

※ To keep the same level of an analog input during t_{AIN} is necessary for charging the electron to the sample hold circuit.

A/D conversion timing

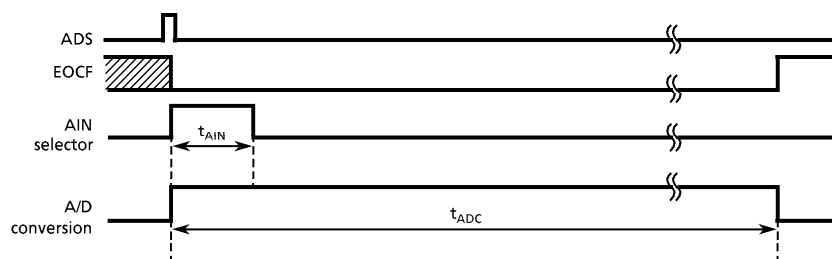

Recommended Oscillating Conditions

(V_{SS} = 0 V, Topr = -30 to 70°C)

Parameter	Oscillator	Oscillation Frequency	Recommended Oscillator	Recommended Conditions	
				C ₁	C ₂
High-frequency Oscillation	Ceramic Resonator	4.19 MHz (VDD = 2.7 to 5.5 V)	MURATA CSA4.19MG	30 pF	30 pF
			MURATA CST4.19MGW	—	—
		4 MHz (VDD = 2.7 to 5.5 V)	MURATA CSA4.00MG	30 pF	30 pF
			MURATA CSA4.00MGC	—	—
			MURATA CST4.00MGW	—	—
			MURATA CSTC4.00MG	—	—
MURATA CSTCS4.00MG	—	—			

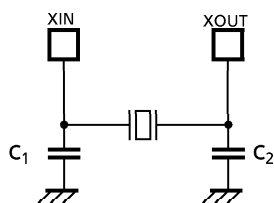

(1) High-frequency Oscillation

Note: When used in high electric field such as a picture tube, the package is recommended to be electrically shielded to maintain a regular operation.