

DE99060ff
4702-Q18710-42

Software Specification
for
Multi Colour TV
System

MN1871681 SB.

Panasonic

All Rights Reserved, 1999
Revision 1.1

Software Engineer Reviewed by *Sidney Lei*

Hardware Engineer Reviewed by _____

Issued by HKDC/PSI(HK)

Approved by _____

Contents

1. Outline	3
2. Main Features	4
3. Pin Configuration	6
4. Terminal Description	7
5. TV Function	8
5.1 Tuning.....	8
5.1.1 <i>Auto Program</i>	8
5.1.2 <i>Auto search up</i>	9
5.1.3 <i>Manual fine tune</i>	9
5.1.4 <i>System mode</i>	10
5.2 Position UP/DOWN.....	10
5.3 Direct Position Selection.....	11
5.4 Volume Control	11
5.5 Picture Control.....	12
5.6 Sound Control.....	12
5.7 Sound Mute.....	13
5.8 AV Control	13
5.9 Sleep Timer.....	14
5.10 Recall	14
5.11 Previous position channel call.....	15
5.12 Power on/off.....	15
5.13 AFC mute control.....	15
5.14 Skip	15
5.15 Normal	16
5.16 Preset picture control	16
5.17 Preset sound control	17
5.18 Languages Selection.....	17
6. Remote control key assign table	18
7. Local control key	19
7.1 Keys assignment	19
7.2 Key input detection voltage	19
8. Manual Adjustment	20
9. Option setting	21
10. Auto Adjustment	22
10.1 MCU process	22
10.2 Adapted computer process	22
11. Service Mode	23
12. Matching Chart of Pin Assigning	24
13. “Fu Lam Moon” Logo	25
14. Appendix	26
14.1 Characters Set	26
14.2 Logo Fonts set.....	34

1. Outline

This is a TV station selection system through the voltage synthesizer in which 8-bit microcontroller MN1871681, AN5195K for TV 1 chip and EEPROM 24C04 are used.

It can be used for both single and multi-system CTV, B/W TV.

2. Main Features

Tuning

- Auto program tuning function
- Auto search tuning function
- Manual fine tuning function
- Direct position selection function
- Position UP/DOWN function
- Previous position / Channel call function
- Position recall function
- Auto colour detection of PAL, SECAM and NTSC(3.58MHz) at TV mode, PAL PAL60, NTSC(3.58MHz & 4.43MHz) and SECAM at AV mode
- All colour system can be set by manual setting function
- Total of 40 program memory or 100 program memory

AV and Sound

- TV/AV function (TV-AV or TV-AV1-AV2 or TV-AV1-AV2-AV3) option
- SIF can be set by manual setting function(BG / DK / I / M)
- Sound Mute function
- Bass/Treble/Balance/Woofer sound control function

PWM

- 7-bit PWM for volume control

Timer

- Sleep timer (120 minutes, 10 minutes per step)

Others

- 8 colour OSD(including black)
- Auto detection of 50/60 Hz for proper OSD
- Automatic power off 10 minutes after no channel broadcasting in TV mode
- Audio and Video mute during channel position change
- 32-key remote control
- 8 local key control
- Last power status memory (channel, picture and sound level setting etc.)
- Last position and volume memory
- Auto audio mute after no channel broadcasting in TV mode
- Selective English/Chinese OSD menu function
- Preset direct picture control function (Standard, Mild, P.P and Dynamic)
- Preset direct sound control function (Standard, News and Music)
- Personal preference function and operation (P.P store and recall)
- Blue back screen function when no signal receiving

3. Pin Configuration

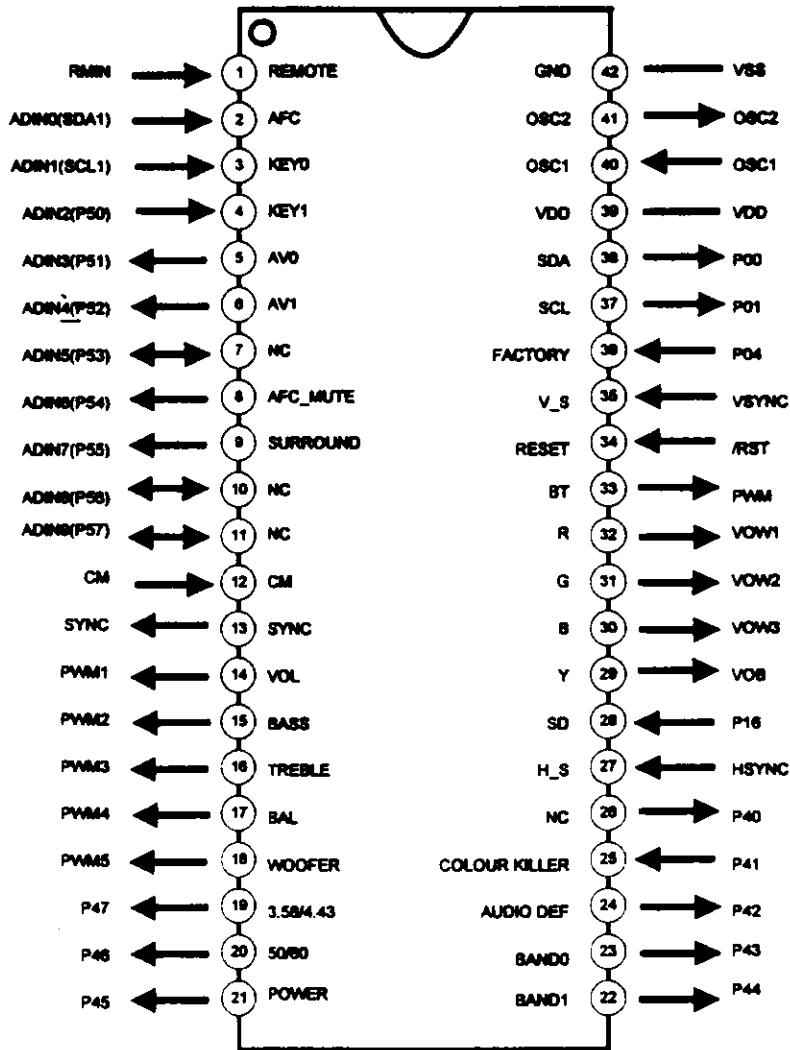

MN1871681 SDIL 42

4. Terminal Description

Pin No.	Name	Symbol	I/O	Description
1	RMIN	REMOTE	I	Remote control signal input terminal
2	ADIN0(SDA1)	AFC	I	AFC input terminal
3	ADIN1(SCL1)	KEY0	I	Key scan input
4	ADIN2(P50)	KEY1	I	Key scan input
5	ADIN3(P51)	AV0	O	AV1, AV2, AV3 selection ^{P52, P51}
6	ADIN4(P52)	AV1	O	(P51, P52 AV1, 10=AV2, 11=AV3)
7	ADIN5(P53)	NC	I/O	No connection
8	ADIN6(P54)	AFC_MUTE	O	No connection
9	ADIN7(P55)	SURROUND	O	Surround sound enable bit (0=off, 1=on)
10	ADIN8(P56)	NC	I/O	No connection
11	ADIN9(P57)	NC	I/O	No connection
12	CM	CM	I	No connection
13	SYNC	SYNC	O	No connection
14	PWM1	VOL	O	Volume control output
15	PWM2	BASS	O	Bass control output
16	PWM3	TREBLE	O	Treble control output
17	PWM4	BAL	O	Balance control output
18	PWM5	WOOFER	O	Woofers control output
19	P47	3.58/4.43	O	3.58/4.43 filter control bit (L=4.43, H=3.58)
20	P46	50/60	O	50/60 Hz selection bit (L=60, H=50)
21	P45	POWER	O	Power control output (H=on, L=off)
22	P44	BAND1	O	Band selection bits (P43, P44=00=UHF, 10=VHF-L, 01=VHF-H)
23	P43	BAND0	O	
24	P42	AUDIO DEF	O	Audio Mute control output (L=off, H=on)
25	P41	COLOUR KILLER	I	Colour killer detection (L=off, H=on)
26	P40	NC	O	No connection
27	HSYNC	H_S	I	Horizontal synchronizing for built in input character generator
28	P16	SD	I	This is a station detection terminal used for audio program and auto search
29	VOB	Y	O	OSD Blank output (L=disable, H=enable)
30	VOW3	B	O	OSD Blue output terminal
31	VOW2	G	O	OSD Green output terminal
32	VOW1	R	O	OSD Red output terminal
33	PWM	BT	O	14 bit PWM output for tuning voltage
34	/RST	RESET	I	Reset terminal (normal=H, active=L)
35	VSNC	V_S	I	Vertical synchronizing input terminal for built in character generator
36	P04	FACTORY	I	Factory mode selection input
37	P01	SCL	OD	Serial Clock pin for I2C
38	P00	SDA	OD	Data pin for I2C
39	VDD	VDD	-	Power supply pin (+5V)
40	OSC1	OSC1	I	MCU oscillator clock input (12MHz)
41	OSC2	OSC2	O	MCU oscillator clock input (12MHz)
42	VSS	GND	-	Ground

00 AV3
01 AV2
10 AV1
11 TV

5. TV Function

5.1 Tuning

TV Tuning function is basically done in tuning menu. The maximum numbers of memorized channel are 40 (0-39) and 100 (0-99) depending on the option bit setup.

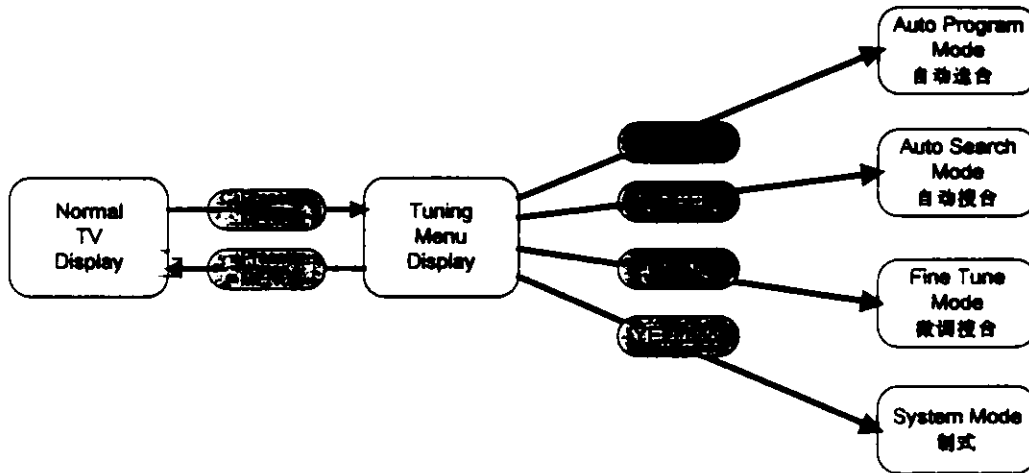

The following tuning functions are provided:

5.1.1 Auto Program

When auto program is activated, all the broadcasting channel in VHF-L, VHF-H and UHF (or UHF only) will be tuned to the best picture and memorized in EEPROM. The searching is in the sequence of VHF-L, VHF-H and UHF and from the minimum BT data to maximum. Upon completion, it will exit tuning menu and enter TV mode at position 1, the broadcasting channel is stored on EEPROM from position 1. Auto program function can only be activated by pressing the related key in tuning menu. If user want to exit during searching, simply press the menu key to exit.

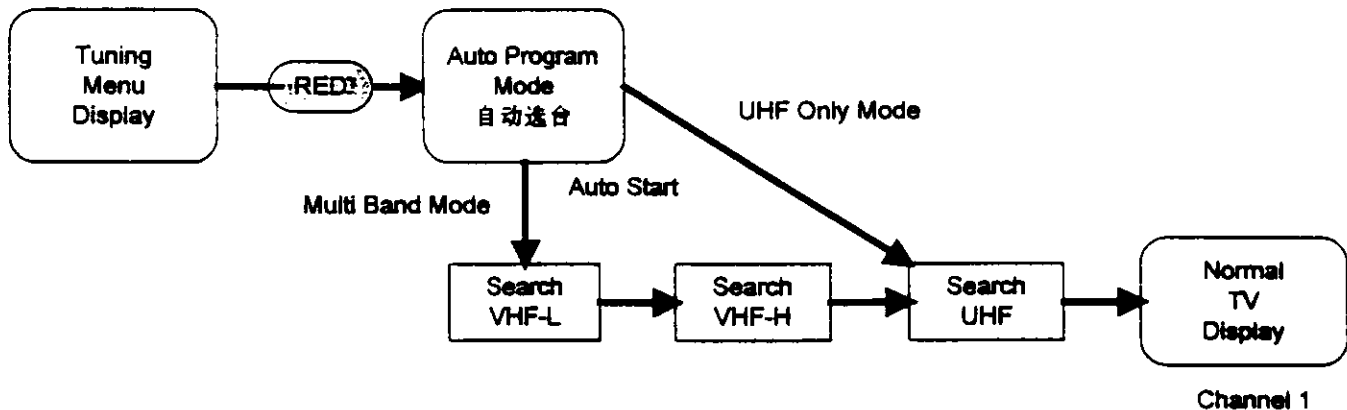

5.1.2 Auto search up

When this function is activated, it will search for the next upper broadcasting channel. When the best picture is found, it will be memorized in EEPROM and return to auto search in preset mode. The searching will go round robin in the sequence of VHF-L, VHF-H and UHF. Auto search UP function can only be activated by pressing the related key in tuning menu.

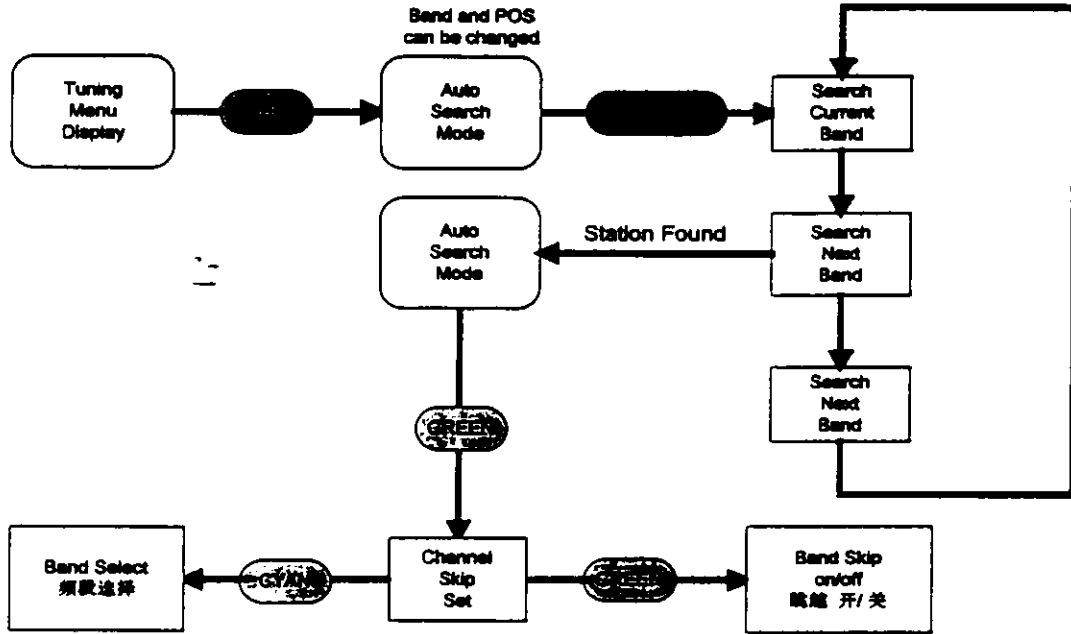

5.1.3 Manual fine tune

Manual fine tuning up and down can be done by pressing volume up or volume down key in tuning menu continuously until the best picture of a broadcasting channel found. The tuning data and band information will be memorized once up or down key was released.

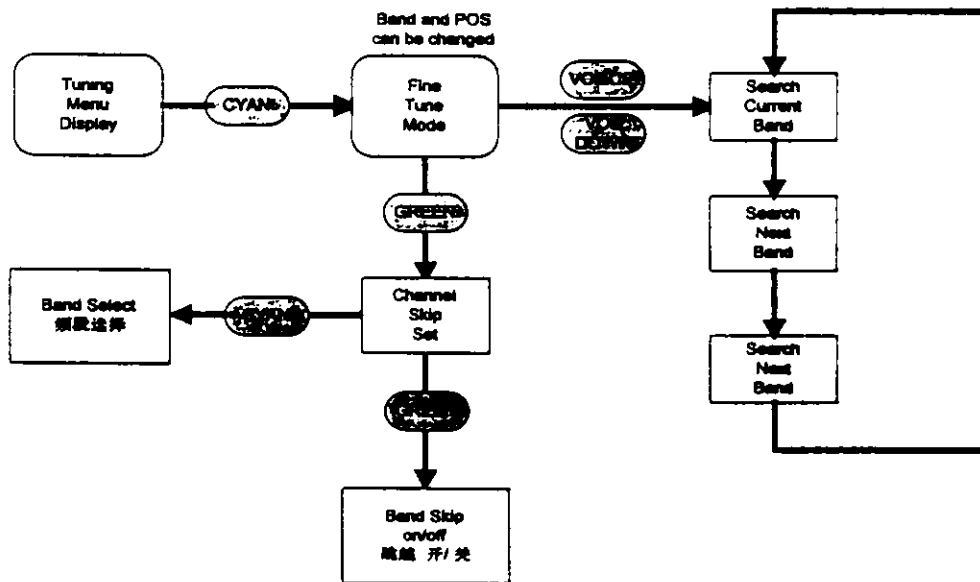

5.1.4 System mode

A Colour and sound system setting can be adjusted manually by the user. The number selection choice of colour and sound system setting would different depending on the option set up. When the system mode menu is selected, pressing the green key will go into the manual colour system setup, pressing the cyan key will go into the auto colour system setup, and pressing the yellow key will go to the sound system setup.

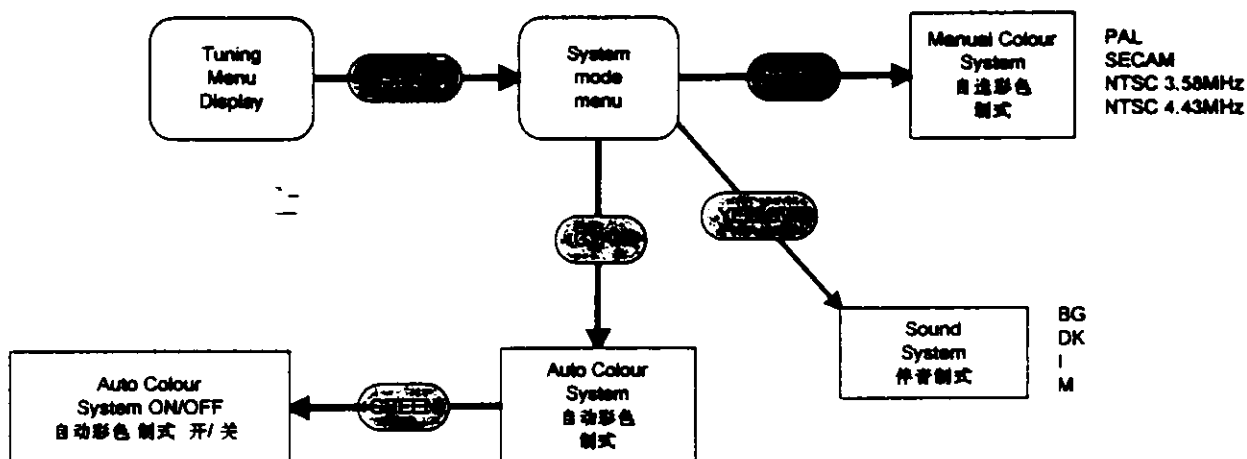

5.2 Position UP/DOWN

This function is carried out among the prestored position in the EEPROM. The sequence is

1. Select the next position number by reading skip position information.
2. Read the BT, Band data, colour and sound system from EEPROM.
3. Output the BT data to tuner through PWM, band data to output port, colour and sound system to AN5195K

In case there is only one station is stored, that mean all the others are skipped, therefore, this station will always be displayed.

In case there is no station is stored (all are skipped), every position will be selected.

5.3 Direct Position Selection

This function is possible by the use of remote control only. As the number of position from 0 up to 39 or 99, position selection is made easy by the use of ten-key. This function is performed by pressing “-/-” key followed by 2 Digits indicating the selecting position.

To select channel 3 : 1 digit input mode

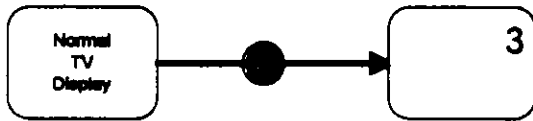

To select channel 47 : 2 digit input mode



5.4 Volume Control

The desired sound volume can be selected by the used of volume UP/DOWN key. Pressing volume key will recall volume OSD and adjustment can be done. At the maximum and minimum, the bar turns red.

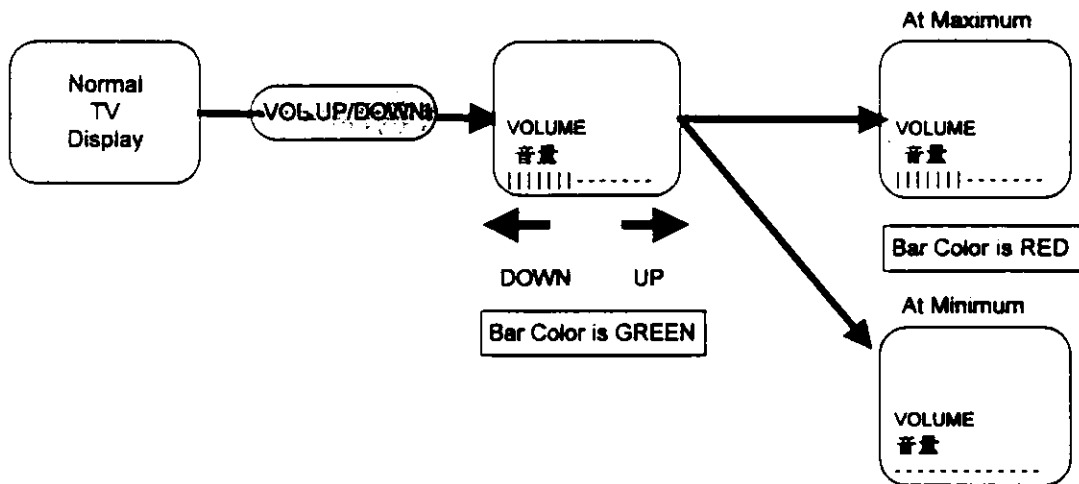

5.5 Picture Control

The Brightness, Contrast, Colour and Tint of the TV picture can be controlled in picture control menu. Pressing picture key will display the picture OSD menu, Brightness, Contrast and Colour setting level can be selected the keys RED, GREEN and CYAN respectively. Adjustment up and down for picture control can be done by volume up and volume down keys.

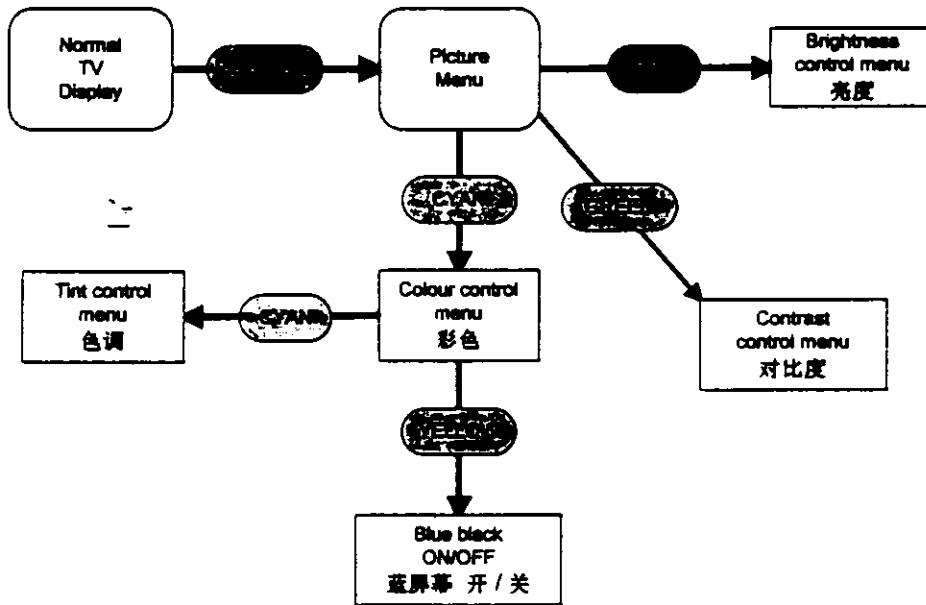

5.6 Sound Control

The Treble, Bass, Balance and Woofer of the TV sound can be controlled in sound control menu. Adjustment up and down for sound level control can be done by pressing volume up/down keys.

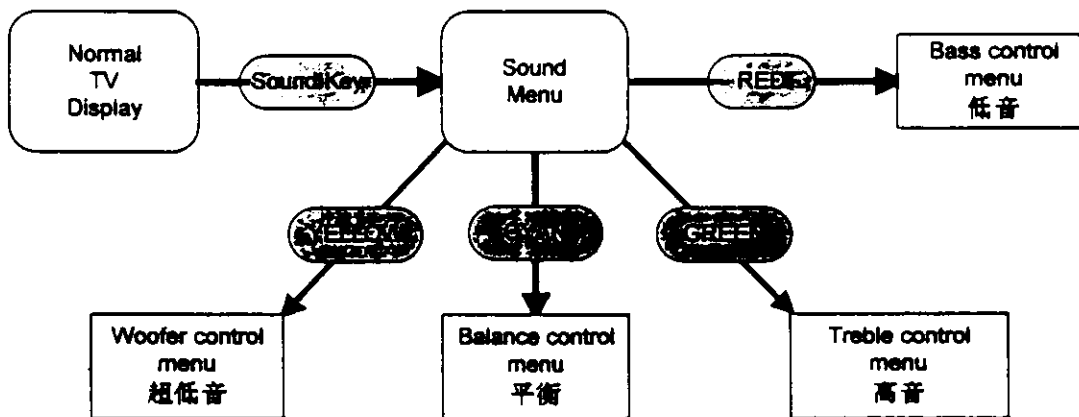

5.7 Sound Mute

The mute mode is controlled by the mute key in remote controller. Mute mode is a state in which the audio sound is completely erased. Pressing the mute key will release the TV from the sound mute state (minimum the output of volume PWM port[pin 14] and disable audio def pin[pin 24]).

Releasing mute mode can be done by pressing mute key itself, volume up/down keys and power off.

Mute function acts not only with this condition but during changing position and detecting no SD signal[pin 28].

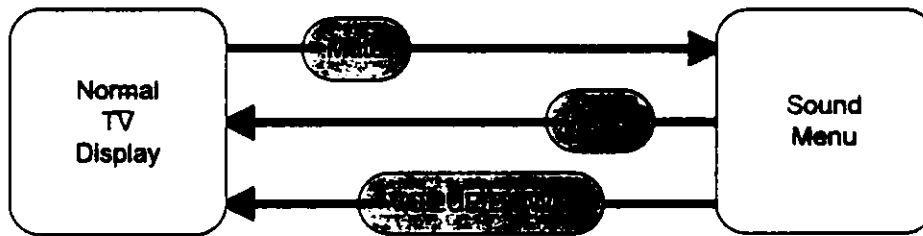

5.8 AV Control

The AV mode is controlled by the TV/AV key. Note that during in AV mode, tens keys, position up/down and tuning menu are not allowed. TV/AV1, TV/AV1/AV2 or TV/AV1/AV2/AV3 depend on the option bit of EEPROM.

Colour system is determined by reading EEPROM of each mode, and send its information to AN5195K.

5.9 Sleep Timer

Sleep key is used to set the sleep timer. At each time pressing the key, setting is made every 10 minutes up until 120 minutes; thereafter, it will be reset to sleep 00. At this state, the sleep timer is off. However, an embedded 10 minutes timer will turn off the TV set if SD pin(pin 28) is inactive for 10 minutes. Otherwise, the TV set will be turned off according to the time set by the sleep timer.

Sleep timer will be released when main power off, power key off, auto power off on no SD signal status.

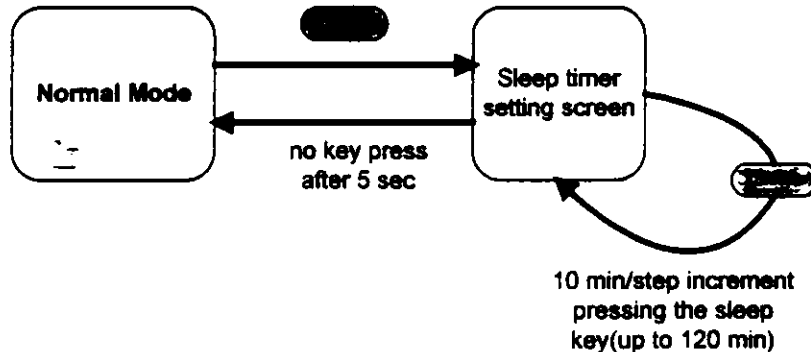

5.10 Recall

Pressing recall key will bring the position number on screen with big size and colour system except AV mode. All information for picture and sound control is displayed. If system is in sleep timer mode, sleep timer information is also displayed. There is no key input within 5 seconds, the big character display will be reduced to small one and it will display permanently. Pressing the key thereafter will cancel the position call.

Status of recall is stored to EEPROM when power on, OSD display determined depend on the EEPROM status.

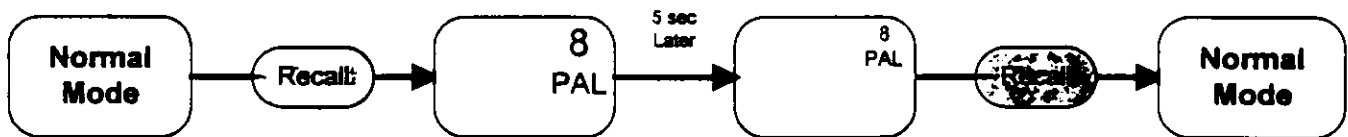

5.11 Previous position channel call

Whenever Q view in the remote control is pressed, the position will be returned to the previous position will be returned to the previous position except in the case that no position channel was changed after the TV power on.

In the case of main power on or power on, last position which stored in EEPROM (means current selected position) become the previous position channel. Therefore, no position channel was changed after the TV power on.

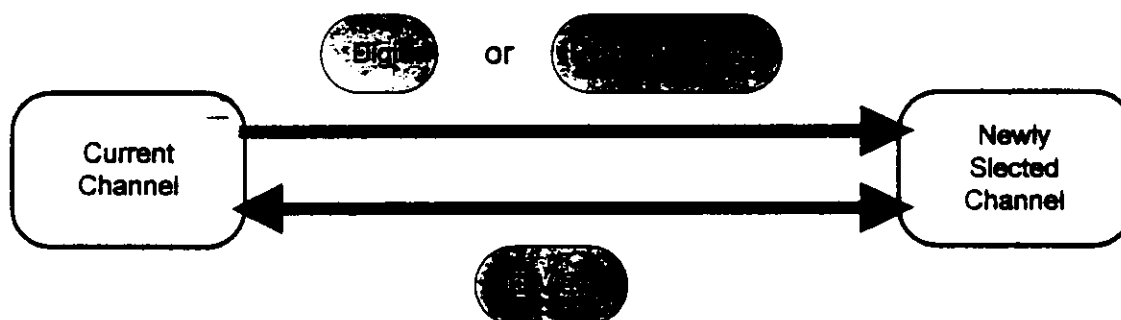

5.12 Power on/off

At each time pressing the power key in the remote control, power on/off control output is reversed. At time of power off, it will accept the local key position up/down key.

5.13 AFC mute control

All auto program and auto search position are initialized to have AFT mute operation off.

5.14 Skip

Skip all position will not be used in after auto program. The position number will change to red. All skip program number change to red colour.

When auto program in process, all BT and band data of tuned station is stored to EEPROM from position 1, the rest of all position will be the skip position. (e.g. when 12 stations tuned, then position 13 to 99 and 0 become skip position.)

During auto search and fine tune, pressing RED key makes that position to skip position. Skip information of each channel is stored in EEPROM.

5.15 Normal

Pressing normal key will bring the Brightness, Contrast, Colour and Tint to defined position stored in EEPROM.

	Min.	Center	Max.	Step
Brightness	0	32	63	64
Contrast	0	32	63	64
Colour	0	32	63	64
Tint	0	32	63	64
Treble	0	32	63	64
Bass	0	32	63	64
Balance	0	32	63	64

Note:

Brightness data is calculated by user adjusted data and factory data. Factory brightness data(sub-brightness) can be adjusted in 64 steps (i.e. 00-3F).

When pressed normal key, no special OSD display appears.

When pressed normal key, all data are stored to EEPROM and send to AN5195K.

5.16 Preset picture control

The Dynamic, Standard, Mild and P.P picture mode can be selected by the user, Dynamic, Standard and Mild are predefined by the factory, Personal Preference(P.P) is presetted by the user. Pressing the picture mode key will display the picture mode menu, at each time of pressing key, setting will be made and switch to another mode. The following illustrated the procedure of setting picture mode.

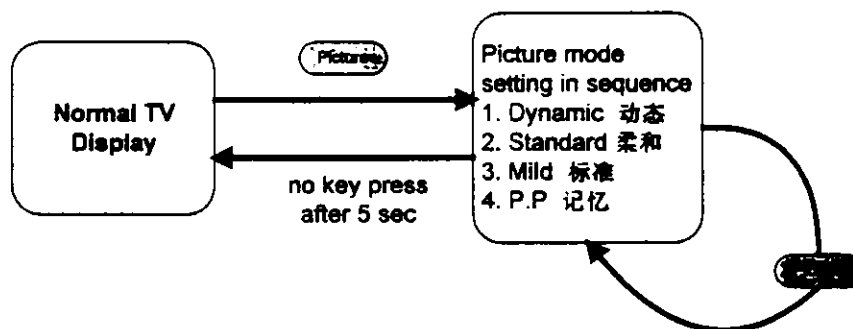

	Dynamic	Standard	Mild	P.P.
Brightness	32	32	32	user defined
Contrast	63(max)	32	20	user defined

5.17 Preset sound control

The News, Music and standard sound mode can be selected by the user, pressing the sound mode key will display the sound mode menu, at each time of pressing key, setting will be made and switch to another mode. The following illustrated the procedure of setting sound mode.

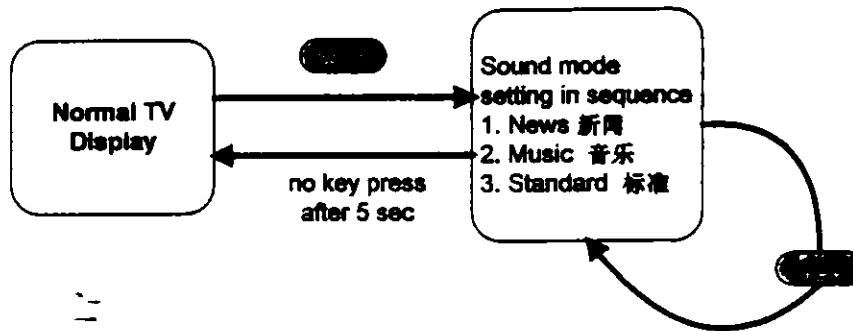

	News	Music	Standard
Bass	22	63(max)	32
Treble	22	63(max)	32

5.18 Languages Selection

Chinese and English OSD menu can be selected by pressing the language key. Once the key has been pressed, a Language selection menu will be shown on TV screen, pressing the same key can be selected between Chinese and English menu display.

6. Remote control key assign table

The Remote Controller is using NEC protocol and customer code is 2 byte format which is x'0a' and x'00'. The following table show the remote control key assign.

	Assigned name	Function
00	0	Direct Function
01	1	Direct Function
02	2	Direct Function
03	3	Direct Function
04	4	Direct Function
05	5	Direct Function
06	6	Direct Function
07	7	Direct Function
08	8	Direct Function
09	9	Direct Function
0A	- / --	Direct position selection, up to 99 positions
0B	Mute	Audio mute control
0C	Picture	TV: Brightness, Contrast, Colour, Tint, Sharpness control
0D	VOL UP	Volume, Tuning & Picture adjustment up
0E	VOL DOWN	Volume, Tuning & Picture adjustment up
0F	POS UP	Position up
10	POS DOWN	Position down
11	Preset	Preset Key
12	Power	Power on/off
13	Sleep	Sleep timer
14	TV/AV	TV/AV changeover
15	Reserved	Reserved
16	recall	Recall the position number
17	Q. View	Quick View
18	Normal	Normal key
19	RED	Item selection key RED
1A	GREEN	Item selection key GREEN
1B	YELLOW	Item selection key YELLOW
1C	()	Item selection key CYAN
1D	Surround	Surround sound key
1E	Sound	Sound control menu
1F	Lang.	English/Chinese selection

40 PreAud preset and TD
 2 Pic Pic preset picture

7. Local control key

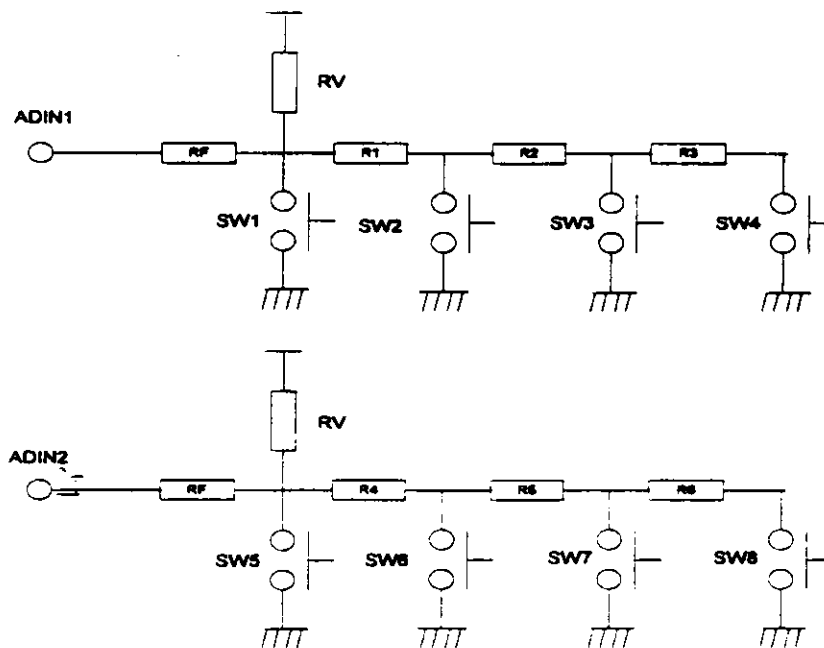

7.1 Keys assignment

Switch	Key function
SW1	TV/AV
SW2	VOL UP
SW3	POS UP
SW4	Preset menu <i>Sound menu</i>
SW5	Standby
SW6	VOL DOWN
SW7	POS DOWN
SW8	Picture menu

7.2 Key input detection voltage

Input Voltage V <i>(±1.5%)</i>	A/D conversion data range	ADIN1	ADIN2
0 - 0.9 <i>0.925</i>	< 06H	TV/AV	Standby
1.1 - 1.7 <i>1.25</i>	< 0CH	VOL UP	VOL DOWN
2.1 - 2.7 <i>2.2125</i>	< 12H	POS UP	POS DOWN
3.0 - 3.6 <i>3.25</i>	< 18H	Preset menu	Picture menu

data (5 bits)

8. Manual Adjustment

To go into the adjustment menu, press the local volume up and down keys simultaneously in switching on the TV set. A picture with adjust menu will be displayed on the screen. All items can be selected in sequence by position up and down keys. Selecting the item then the volume bar is green in colour will be displayed indicating the current value in the EEPROM of adjust item. Change the item value by volume up/down keys, the new adjustment value will be stored in the EEPROM. The screen will stay until power off.

Manual Adjustment function

Key	Item	Display	Ranges	Step
0	Video Adjust	VAD	0-7	8
1	AFT	AFT	0-1FF	512
2	RFAGC	RFAGC	0-3F	64
3	VCO	VCO	0-7F	128
4	Cutoff-R	C-R	0-FF	256
5	Cutoff-G	C-G	0-FF	256
6	Cutoff-B	C-B	0-FF	256
7	Drive-R	D-R	0-7F	128
8	Drive-B	D-B	0-7F	128
9	Sub-Brightness	S-B	0-3F	64
Mute	H Center	H-C	0-7	8

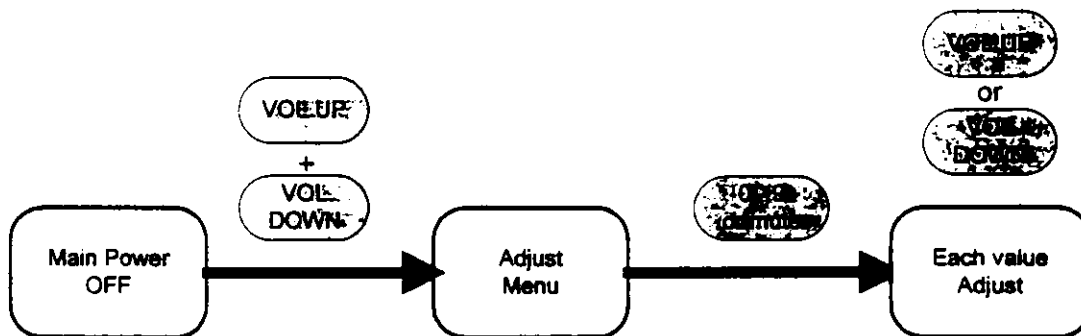

9. Option setting

To go into the option menu, press the local position up and down keys simultaneously in switching on the TV set. A picture with option number will be shown on the screen. The upper line represent the group of setting according to the following table, lower line represent the option value in the range of 0-7.

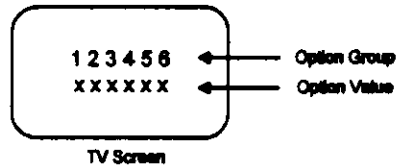

The number is in GREEN colour indicating the current options in the EEPROM. With 0-7 keys, change the digits position from left to right by volume up/down key and change the digit value by direct digit keys. Changed digit will become RED. Every Time the option setting is changed, the new option number will be stored in the EEPROM.

EEPROM Data Address	Data bit	Option Group	Bit	Item	Option value								
					0	1	2	3	4	5	6	7	
00H	0	1	Stereo	0	Bass/Treble/Balance	x	✓	x	✓	-	-	-	-
	1			Woofer	x	x	✓	✓	-	-	-	-	
	2			Reserved	-	-	-	-	-	-	-	-	
00H	4	2	Colour Sys	0	SECAM	x	✓	x	✓	-	-	-	-
	5			RF NTSC	x	x	✓	✓	-	-	-	-	
	6			Reserved	-	-	-	-	-	-	-	-	
01H	0	3	AV Mode	0	0 = AV1 only 1 = AV1 & AV2	x	✓	x	✓	-	-	-	-
	1			2 = AV1 only 3 = AV1, AV2 & AV3	x	x	✓	✓	-	-	-	-	
	2			Reserved	-	-	-	-	-	-	-	-	
01H	4	4	Sound Sys 1	0	B/G (5.5MHz)	x	✓	x	✓	x	✓	x	✓
	5			D/K (6.5MHz)	x	x	✓	✓	x	x	✓	✓	
	6			I (6.0MHz)	x	x	x	x	✓	✓	✓	✓	
02H	0	5	Sound Sys 2	0	M (4.5MHz)	x	✓	x	✓	-	-	-	-
	1			Start up LOGO	x	x	✓	✓	-	-	-	-	
	2			Reserved	-	-	-	-	-	-	-	-	
02H	4	6	Auto Tuning	0	Search Down	x	✓	x	✓	x	✓	x	✓
	5			UHF Only (✓=UHF, x=UHF/VHF-L/H)	x	x	✓	✓	x	x	✓	✓	
	6			Channel (✓=100, x=40)	x	x	x	x	✓	✓	✓	✓	

x = Disable ✓ = Enable

10. Auto Adjustment

When the factory pin of MCU (pin 36) goes LOW, it will go into factory mode. The factory mode will disable the TV operation and the I2C bus transmission. When main power is off, then exit the auto adjustment mode.

10.1 MCU process

1. When MCU detect the factory pin (pin36) is "L" level, then it make I2C bus terminal in hi-impedance status whiten 100ms and release these bus.
2. In this mode, all local key, remote key disable and all action become prohibited.
3. All the terminal status except I2C bus and OSD port remain the latest status just before the factory pin detected "L".
4. OSD display are prohibited.
5. After this mode when factory pin detect "H", then read EEPROM data to on-chip RAM and restart from the "RESET START" status (branch to reset start address).
6. After this process all data stored in EEPROM and send to AN5195K is based on on-chip RAM.

10.2 Adapted computer process

1. Make factory pin "L" and wait 100ms.
2. Initial setting of AN5195K is operated by operator.
3. The same data set on AN5195K must be sent to EEPROM.
4. Make factory pin "H"

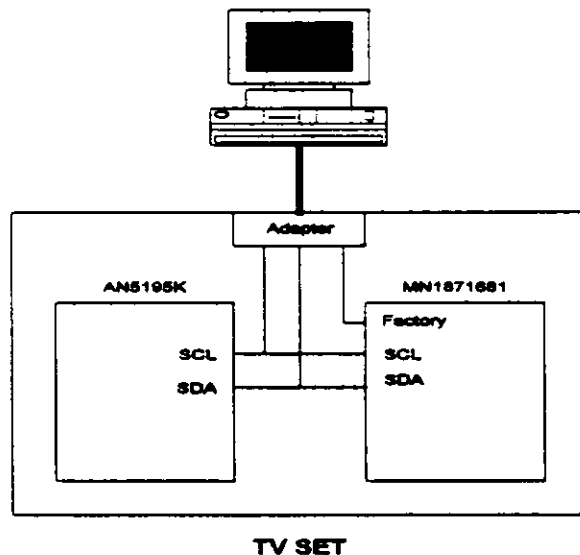

11. Service Mode

To go into the service mode, press local keys TV/AV and stand-by simultaneously in switching on the TV set. The TV set will power on such as normal power on. This service mode is for disabling the automatic power off 10 minutes after no channel broadcasting in production line.

12. Matching Chart of Pin Assigning

Pin No.	Pin Name MN1876476	I/O	Pin No.	Pin Name MN1871681	I/O
1	P06/RMIN	I	1	RMIN	I
2	ADIN0(SDA1)	I/O	2	ADIN0(SDA1)	I
3	ADIN1(SCL1)	I/O	3	ADIN1(SCL1)	I
4	ADIN2(P50)	I/O	4	ADIN2(P50)	I
5	ADIN3(P51)	I/O	5	ADIN3(P51)	O
6	ADIN4(P52)	I/O	6	ADIN4(P52)	O
7	ADIN5(P53)	I/O	7	ADIN5(P53)	I/O
8	ADIN6(P54)	I/O	8	ADIN6(P54)	O
9	ADIN7(P55/IRQ2)	I/O	9	ADIN7(P55)	O
10	ADIN8(P56/IRQ3)	I/O	10	ADIN8(P56)	I/O
11	ADIN9(P57/ACIN)	I/O	11	ADIN9(P57)	I/O
12	CM	I	12	CM	I
13	SYNC	O	13	SYNC	O
14	PWM1(P30)	I/O	14	PWM1	O
15	PWM2(P31)	I/O	15	PWM2	O
16	PWM3(P32)	I/O	16	PWM3	O
17	PWM4(P33)	I/O	17	PWM4	O
18	PWM5(P34)	I/O	18	PWM5	O
19	PWM6(P35)	I/O			
20	PWM7(P36)	I/O			
21	PWM8(P37)	I/O			
22	AVDD	-			
23	CREF	O			
24	VPH	O			
25	VCP	O			
26	CVBS	I			
27	AVSS	-			
28	P47	I/O	19	P47	O
29	P46	I/O	20	P46	O
30	P45	I/O	21	P45	O
31	P44	I/O	22	P44	O
32	P43	I/O	23	P43	O
33	P42	I/O	24	P42	O
34	P41	I/O	25	P41	I
35	P40	I/O	26	P40	O
36	P21/XO	I/O			
37	P20/XI	I/O			
38	VSS	-			
39	HSYNC	I	27	HSYNC	I
40	P16/SD	I	28	P16	I
41	P15/(VOB)	I/O	29	VOB	O
42	P14(VOW3)	I/O	30	VOW3	O
43	P13(VOW2)	I/O	31	VOW2	O
44	P12(VOW1)	I/O	32	VOW1	O

Pin No.	Pin Name MN1876476	I/O	Pin No.	Pin Name MN1871681	I/O
46	P10(PWM/VOI)	I/O	33	PWM	O
47	P66	O			
48	P65	O			
49	P64	O			
50	P63	O			
51	P62	O			
52	P61	O			
53	P60	O			
54	P07//RST	I/O	34	/RST	I
55	P05/IRQ1/VSYN	I	35	VSYN	I
56	P04/IRQ0	I/O	36	P04	I
57	P03(/SBD)	I/O			
58	P02(/SBT0)	I/O			
59	P01(SDA0)	I/O	37	P01	OD
60	P00(SCL0)	I/O	38	P00	OD
61	VDD	-	39	VDD	-
62	OSC1	I	40	OSC1	I
63	OSC2	O	41	OSC2	O
64	VSS	-	42	VSS	-

13. “Fu Lam Moon” Logo

When the TV is turned into the operation mode, in no signal mode (Blue Back option is “ON”) and by pressing RECALL KEY, the “Fu Lam Moon” logo will appear on the screen. It will last for 5 seconds. Seven different color of the graphic logo can be selected by pressing the “RECALL KEY”. The default color of the logo is red in color. The default color will be resumed by the TV “ON/OFF POWER KEY”. “STAND BY KEY” will keep the current graphic color.

13. Appendix

13.1 Characters Set

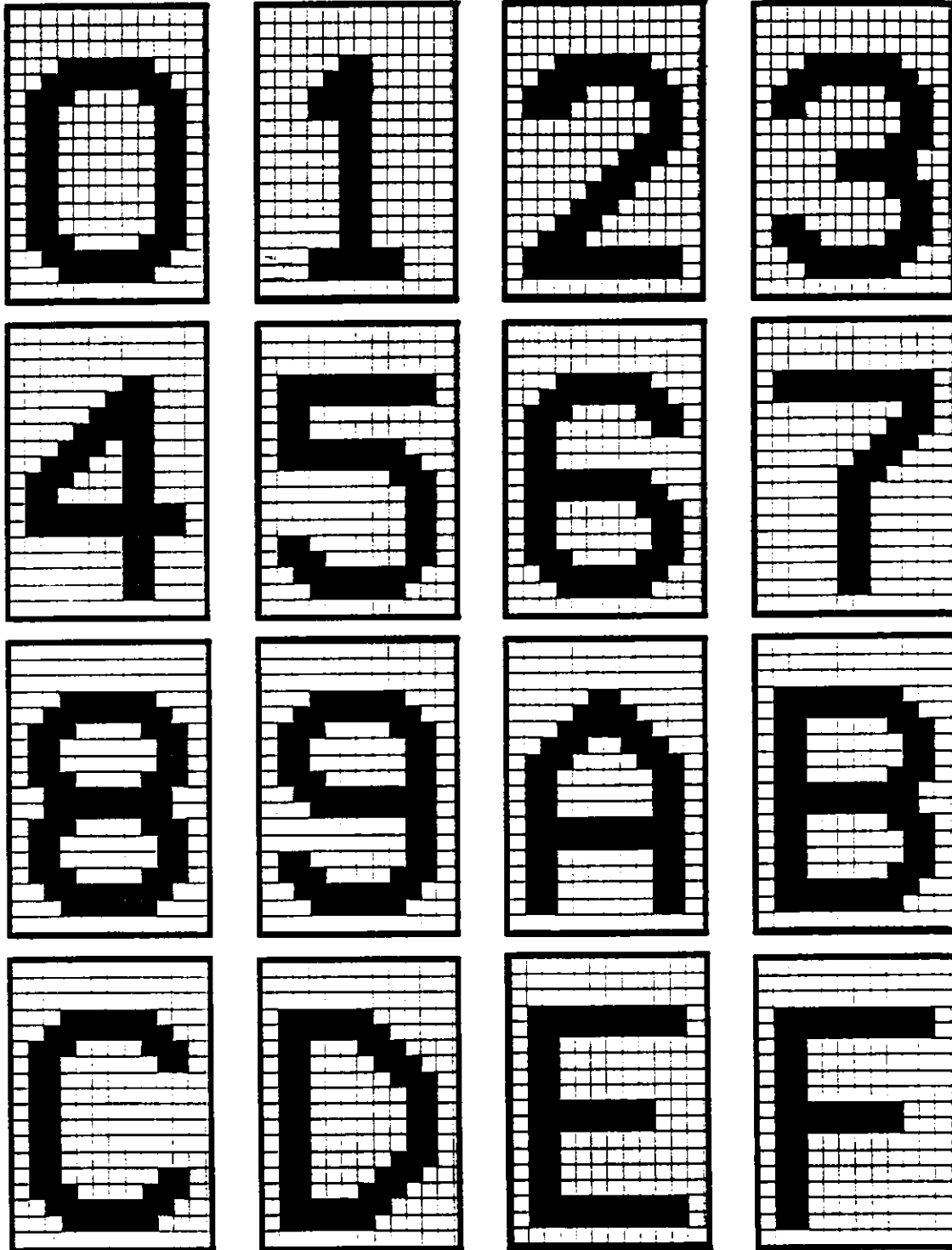

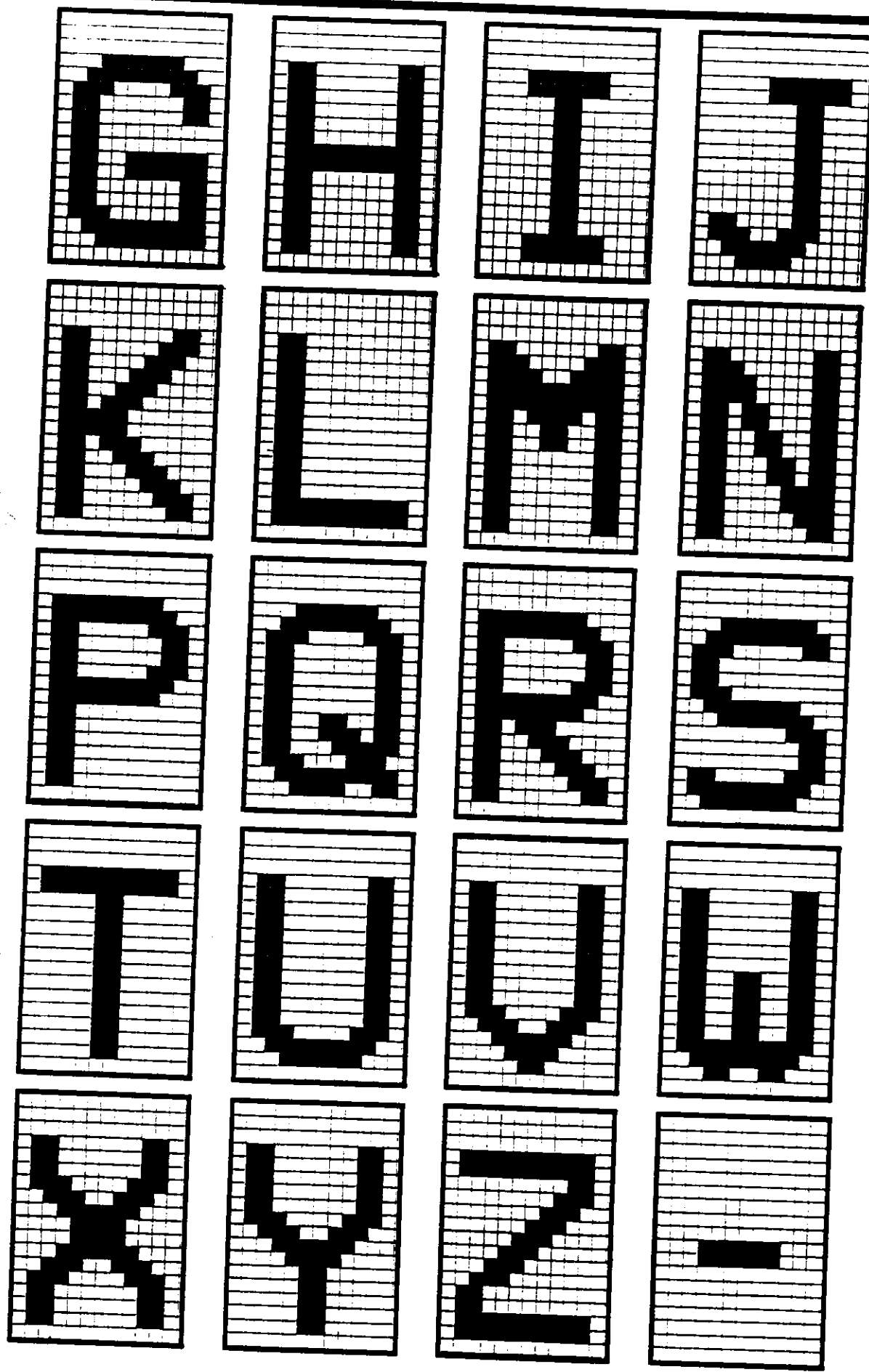

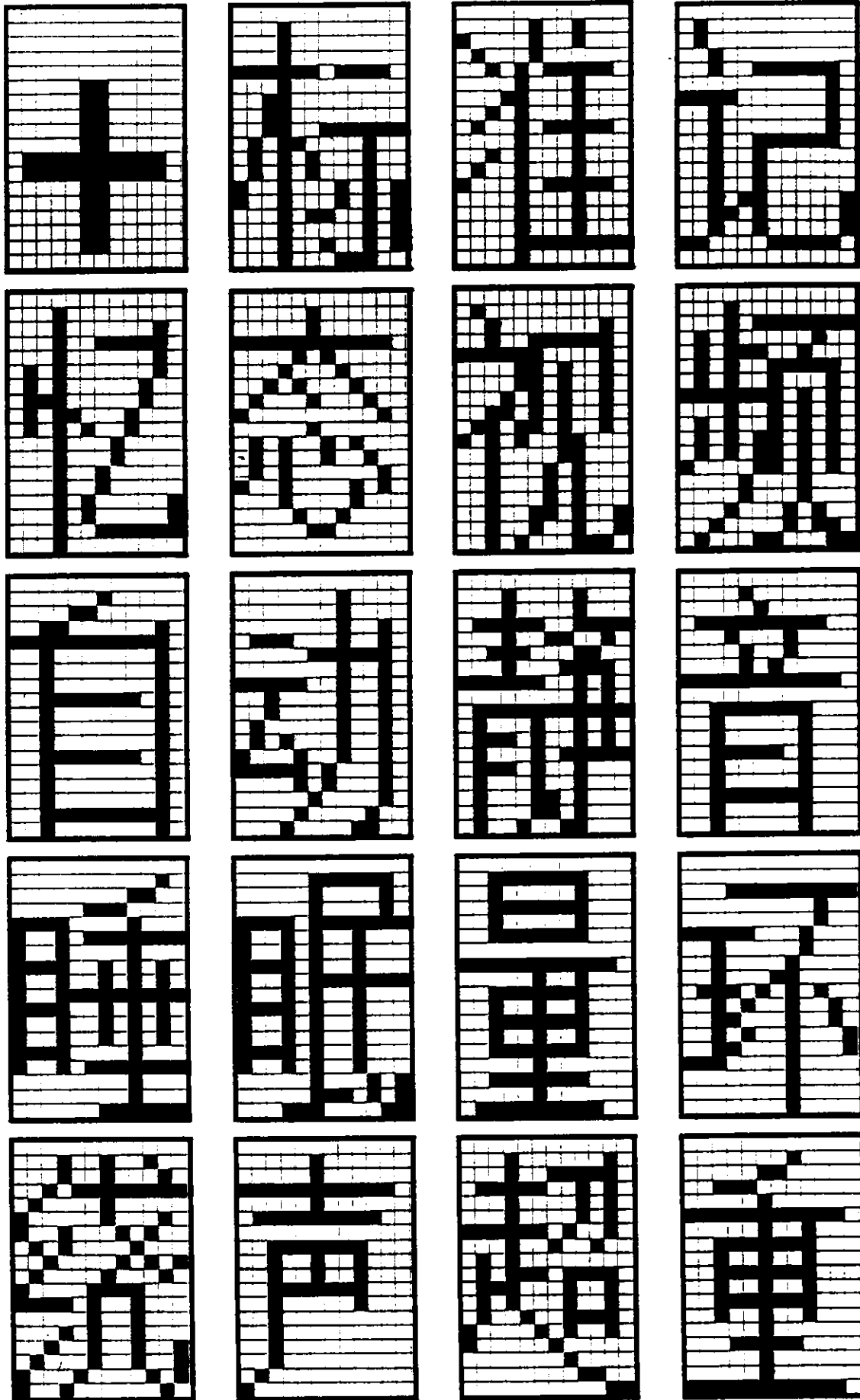

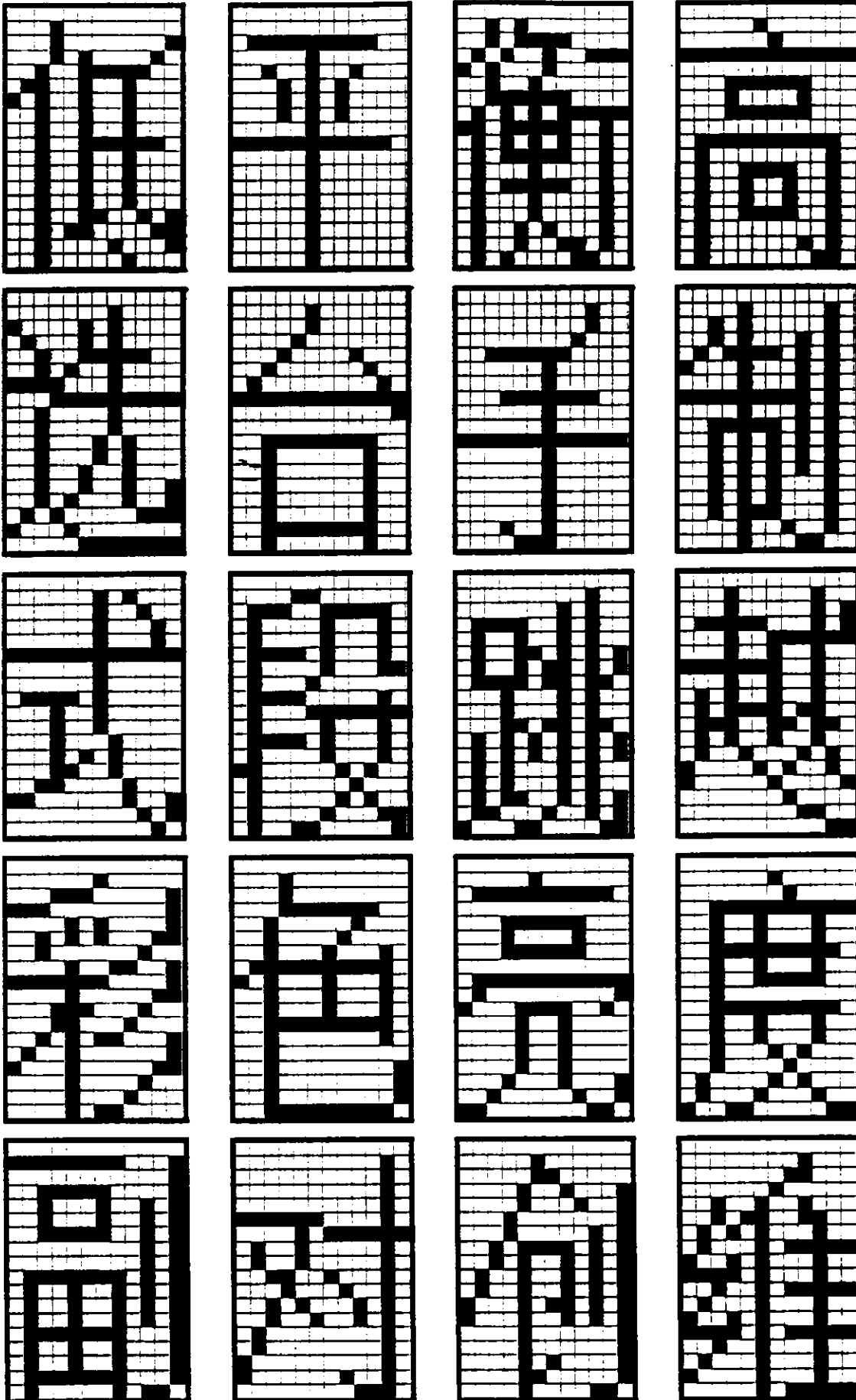

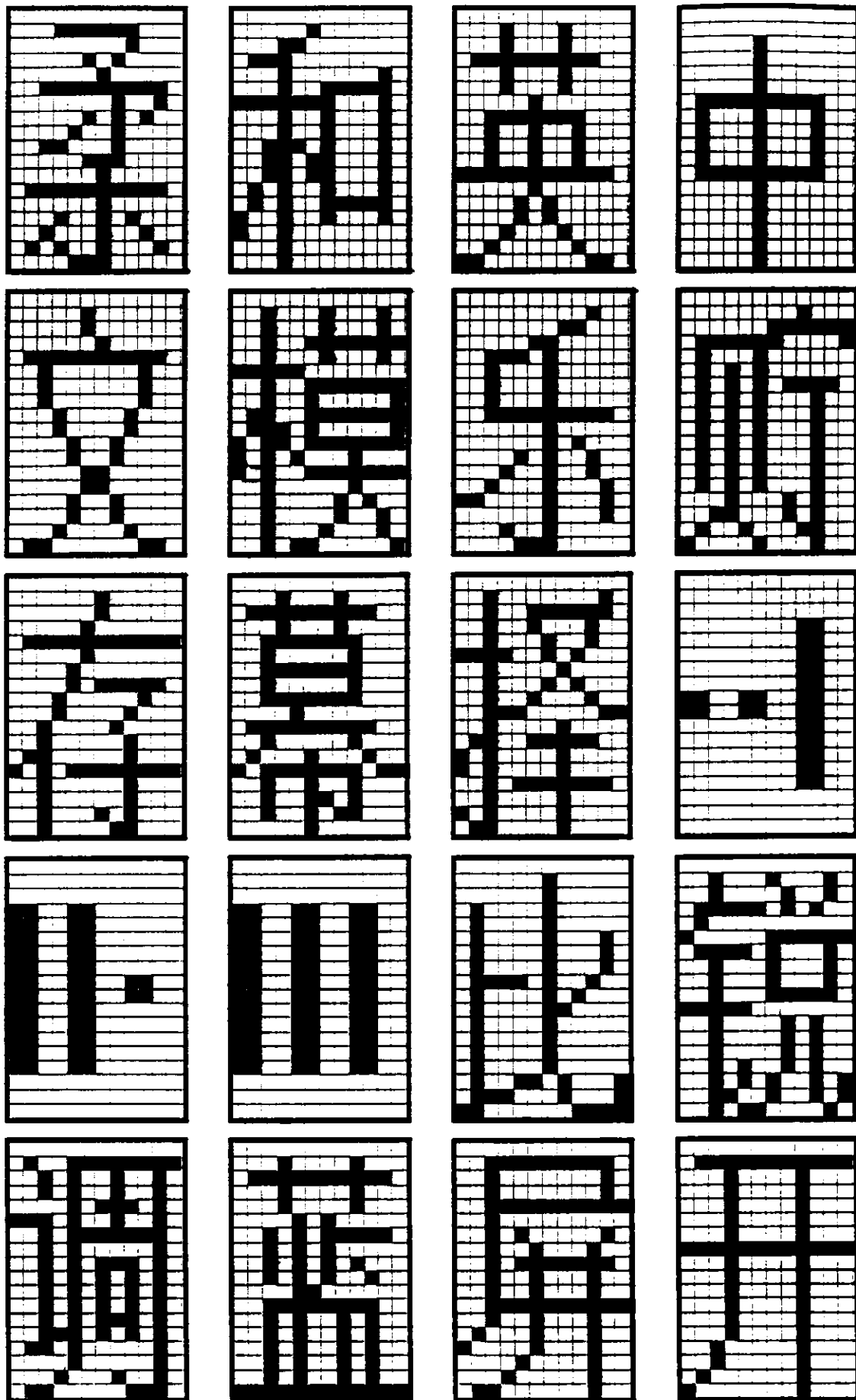

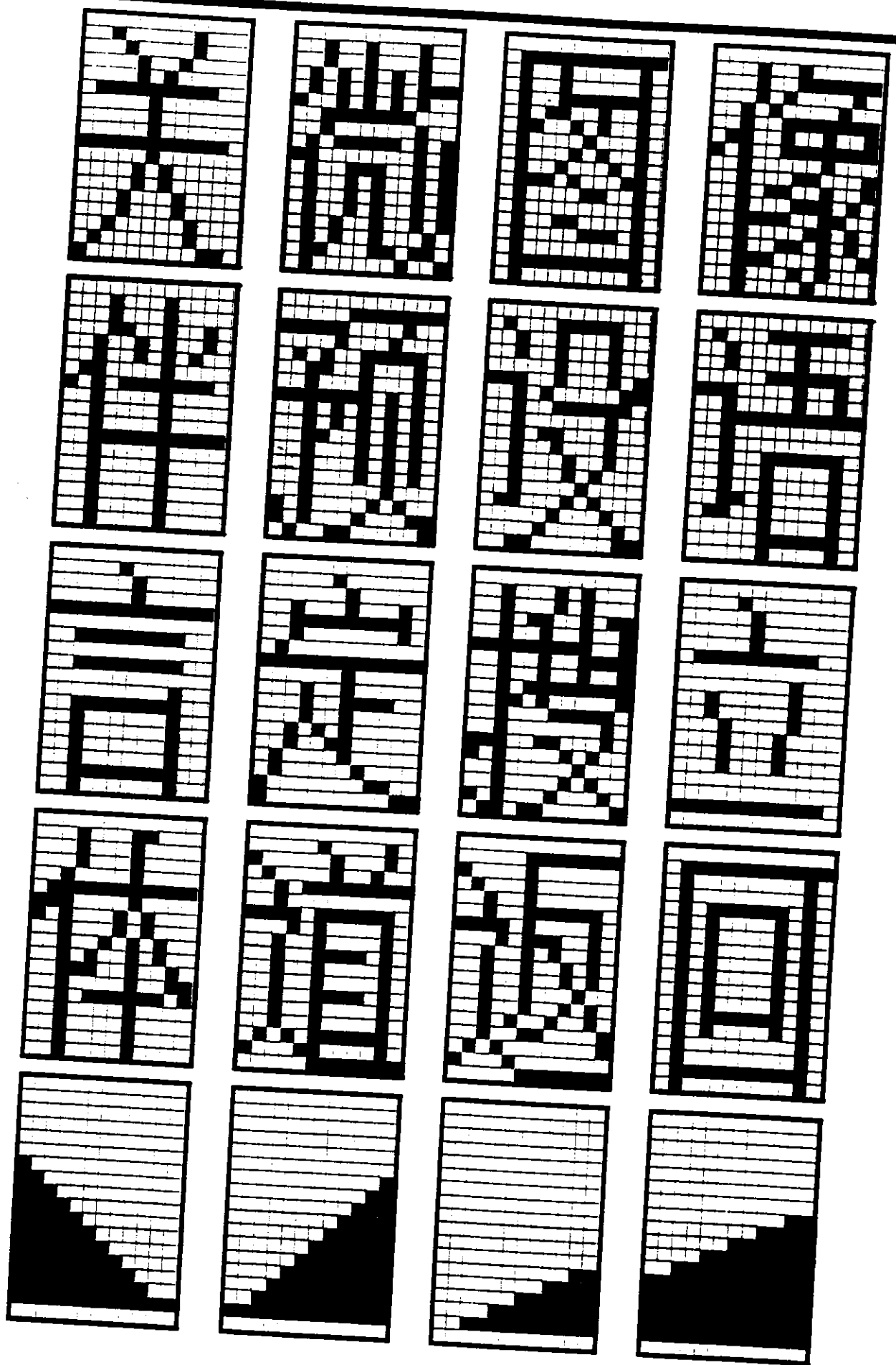

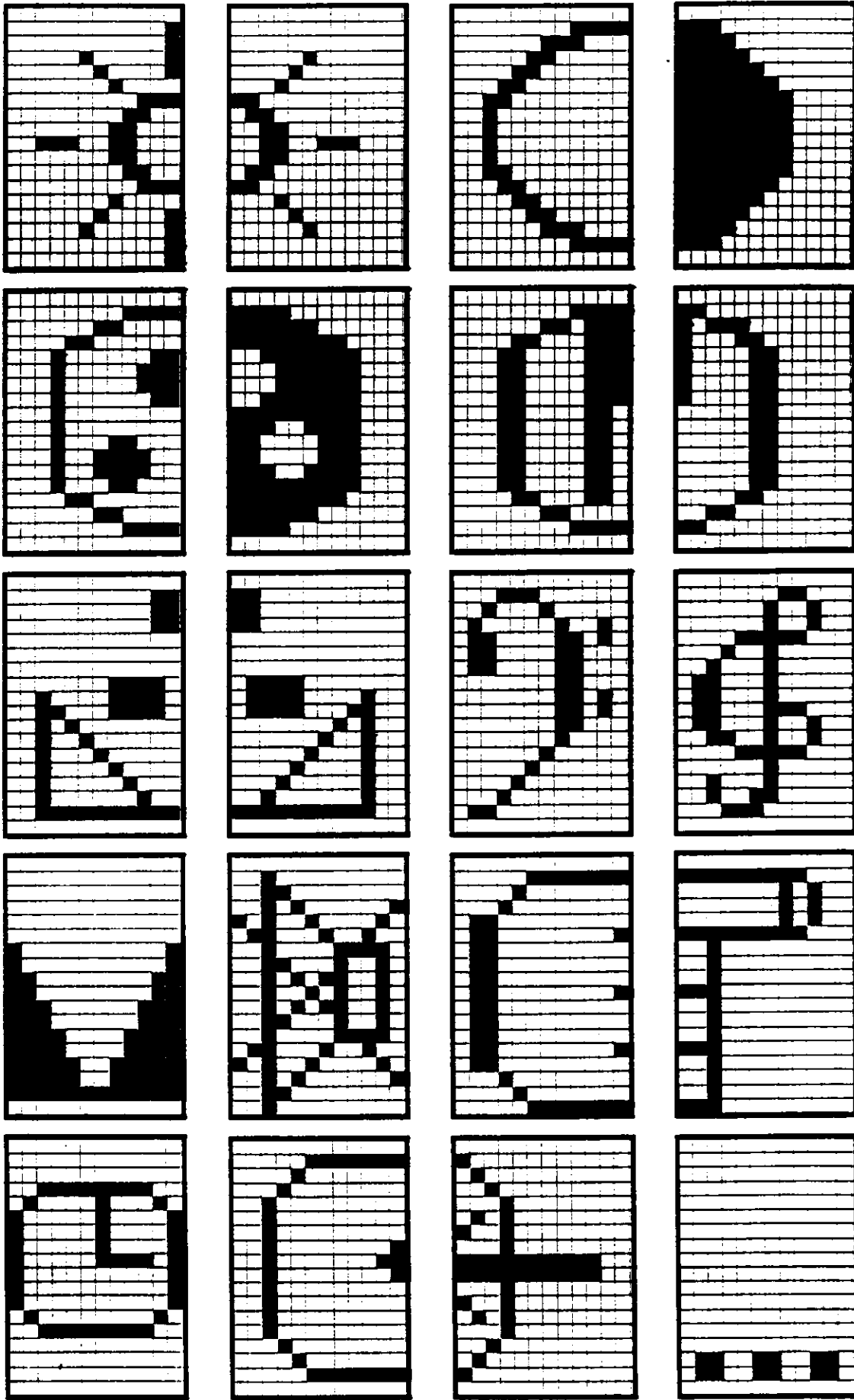

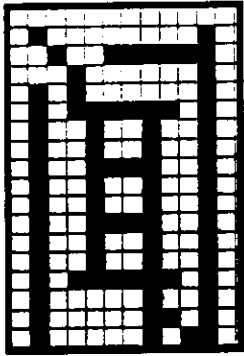
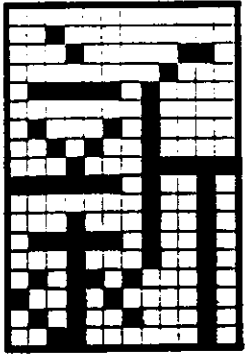

13.2 Logo Fonts set

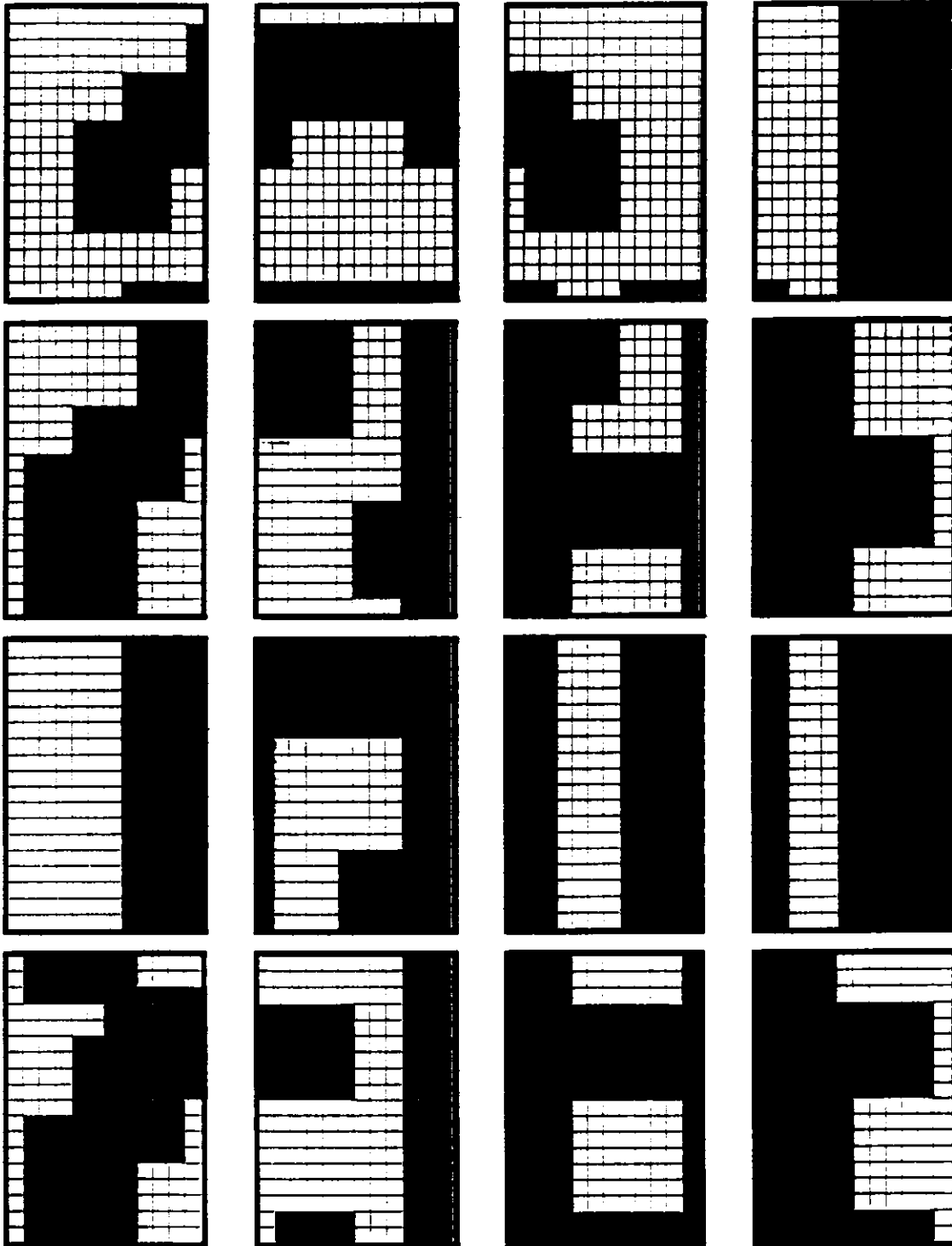

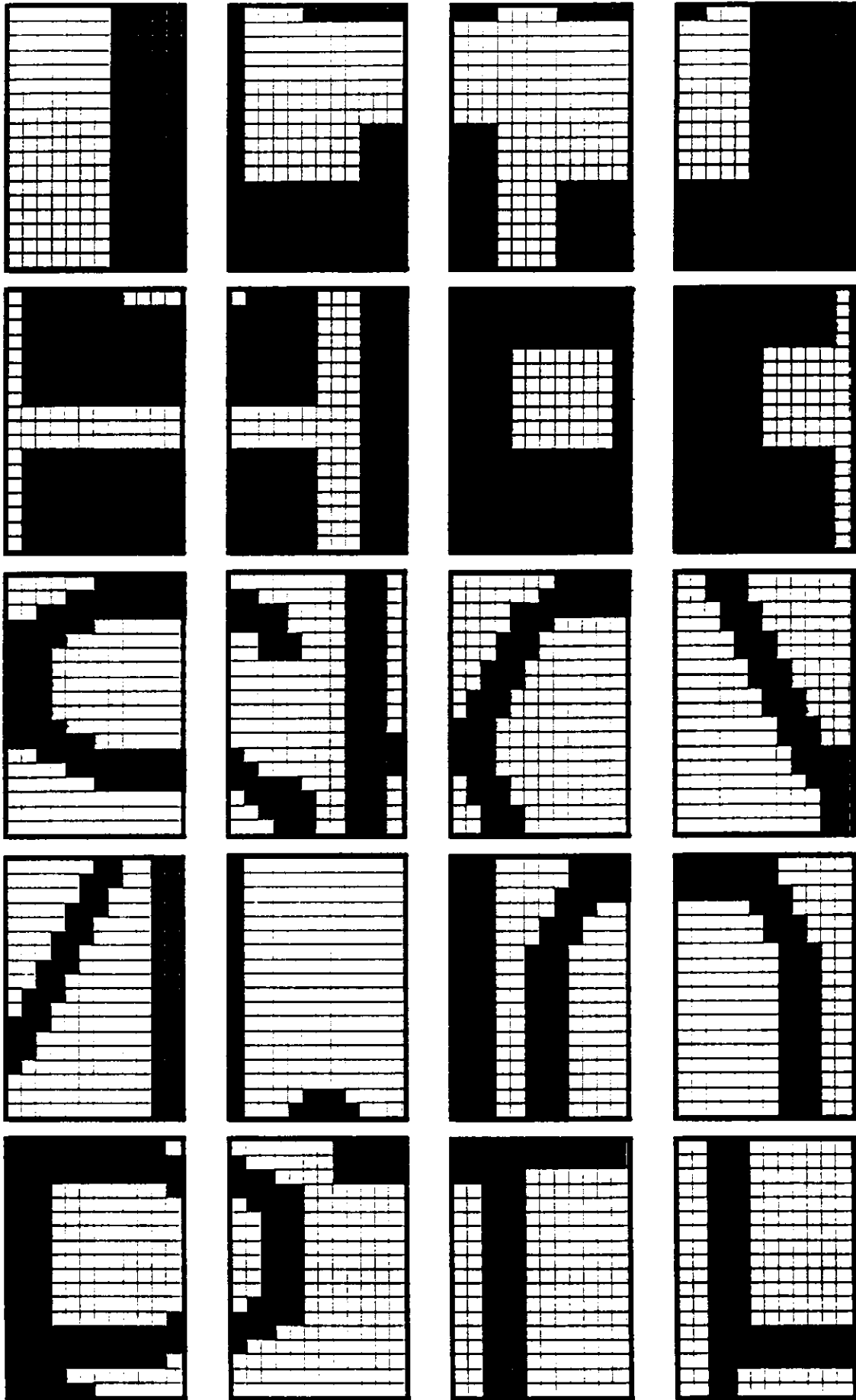

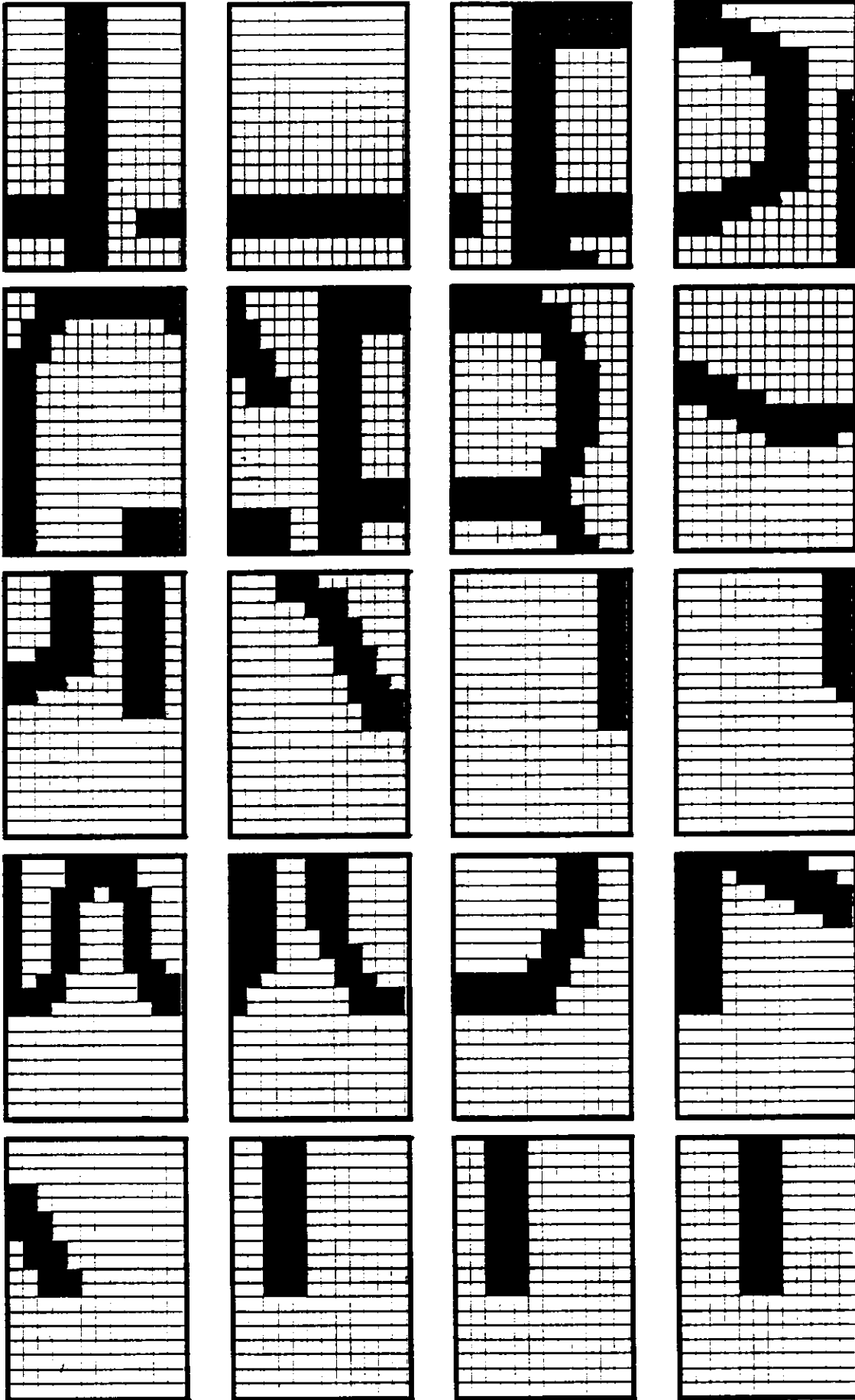

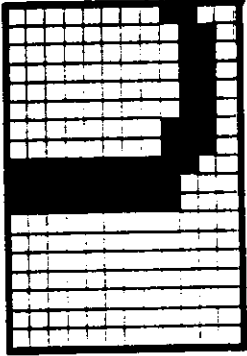
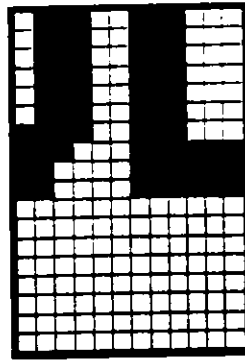
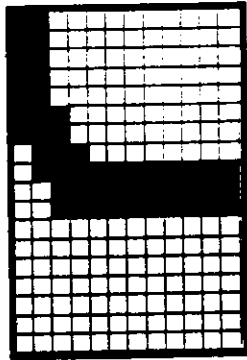
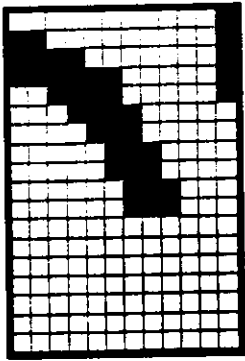
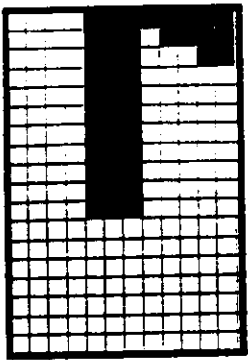

— End of Specification —

The contents of this document are subject to change without notice.

The information and block diagrams in this document presented as the most currently software design applications, and are not intended to be finalized on those specifications.

The software and all title of this document are protected under copyright law by Panasonic. No part of this document and software may be stored in a retrieval system, reproduced in any way, including but not limited to photocopy, photograph, magnetic or other record, without the prior agreement and written permission of the Panasonic.

Panasonic Shun Hing Industrial Sales (HK) Co., Ltd.

Hong Kong Design Centre

11/F, Great Eagle Centre, 23 Harbour Road,

Wanchai, Hong Kong

Tel : 2529 7322 Fax : 2865 4455