

BCR6AM

MEDIUM POWER USE
NON-INSULATED TYPE, PLANAR PASSIVATION TYPE

BCR6AM



- **IT (RMS)** **6A**
- **VDRM** **400V/600V**
- **IFGT I , IRGT I , IRGT III** **30mA (20mA) *5**

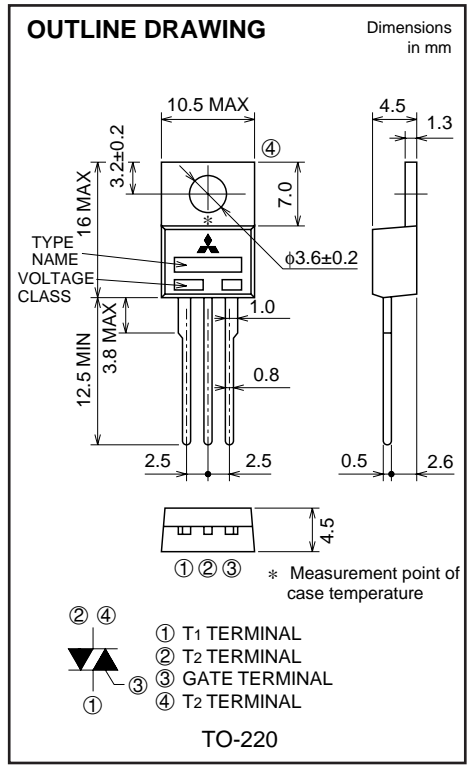

APPLICATION

Contactless AC switches, light dimmer, electric flasher unit, control of household equipment such as TV sets · stereo · washing machine · infrared kotatsu · carpet · electric fan, solenoid drivers, small motor control, copying machine, other general purpose control applications

MAXIMUM RATINGS

| Symbol | Parameter | Voltage class | | Unit |
|--------|--|---------------|-----|------|
| | | 8 | 12 | |
| VDRM | Repetitive peak off-state voltage *1 | 400 | 600 | V |
| VDSM | Non-repetitive peak off-state voltage *1 | 500 | 720 | V |

| Symbol | Parameter | Conditions | Ratings | Unit |
|------------------|--------------------------------|--|------------|------------------|
| IT (RMS) | RMS on-state current | Commercial frequency, sine full wave 360° conduction, Tc=103°C | 6 | A |
| ITSM | Surge on-state current | 60Hz sinewave 1 full cycle, peak value, non-repetitive | 60 | A |
| I ² t | I ² t for fusing | Value corresponding to 1 cycle of half wave 60Hz, surge on-state current | 15 | A ² s |
| PGM | Peak gate power dissipation | | 5 | W |
| PG (AV) | Average gate power dissipation | | 0.5 | W |
| VGM | Peak gate voltage | | 10 | V |
| IGM | Peak gate current | | 2 | A |
| Tj | Junction temperature | | -40 ~ +120 | °C |
| Tstg | Storage temperature | | -40 ~ +125 | °C |
| — | Weight | Typical value | 2.0 | g |

*1. Gate open.

BCR6AM

MEDIUM POWER USE

NON-INSULATED TYPE, PLANAR PASSIVATION TYPE

ELECTRICAL CHARACTERISTICS

| Symbol | Parameter | Test conditions | Limits | | | Unit | |
|----------------------|--|--|--------|------|------|------|----|
| | | | Min. | Typ. | Max. | | |
| IDRM | Repetitive peak off-state current | T _j =125°C, V _{DRM} applied | — | — | 2.0 | mA | |
| V _{TM} | On-state voltage | T _c =25°C, I _{TM} =9A, Instantaneous measurement | — | — | 1.7 | V | |
| V _{FGT I} | Gate trigger voltage *2 | T _j =25°C, V _D =6V, R _L =6Ω, R _G =330Ω | I | — | — | 1.5 | V |
| V _{RGT I} | | | II | — | — | 1.5 | V |
| V _{RGT III} | | | III | — | — | 1.5 | V |
| I _{FGT I} | Gate trigger current *2 | T _j =25°C, V _D =6V, R _L =6Ω, R _G =330Ω | I | — | — | 30*5 | mA |
| I _{RGT I} | | | II | — | — | 30*5 | mA |
| I _{RGT III} | | | III | — | — | 30*5 | mA |
| V _{GD} | Gate non-trigger voltage | T _j =125°C, V _D =1/2V _{DRM} | 0.2 | — | — | V | |
| R _{th(j-c)} | Thermal resistance | Junction to case *4 | — | — | 2.5 | °C/W | |
| (dv/dt) _c | Critical-rate of rise of off-state commutating voltage | | *3 | — | — | V/μs | |

- *2. Measurement using the gate trigger characteristics measurement circuit.
- *3. The critical-rate of rise of the off-state commutating voltage is shown in the table below.
- *4. The contact thermal resistance R_{th(c-f)} in case of greasing is 1.0°C/W.
- *5. High sensitivity (I_{GT}≤20mA) is also available. (IGT item ①)

| Voltage class | V _{DRM} (V) | (dv/dt) _c | | | Test conditions | Commutating voltage and current waveforms (inductive load) |
|---------------|----------------------|----------------------|------|------|--|--|
| | | Symbol | Min. | Unit | | |
| 8 | 400 | R | — | V/μs | 1. Junction temperature T _j =125°C 2. Rate of decay of on-state commutating current (di/dt) _c =-3A/ms 3. Peak off-state voltage V _D =400V | |
| | | L | 10 | | | |
| 12 | 600 | R | — | | | |
| | | L | 10 | | | |

PERFORMANCE CURVES

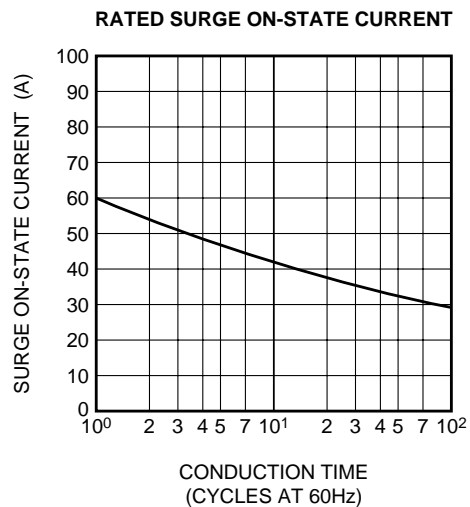
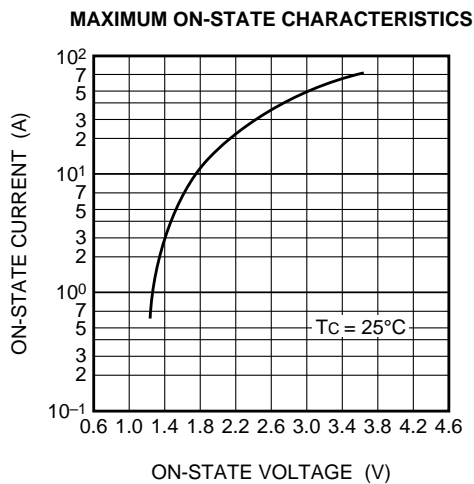

BCR6AM

MEDIUM POWER USE

NON-INSULATED TYPE, PLANAR PASSIVATION TYPE

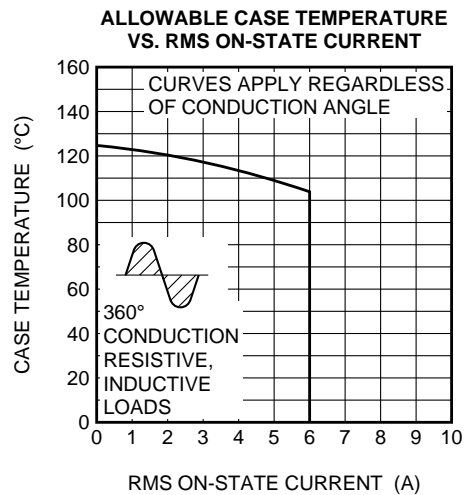
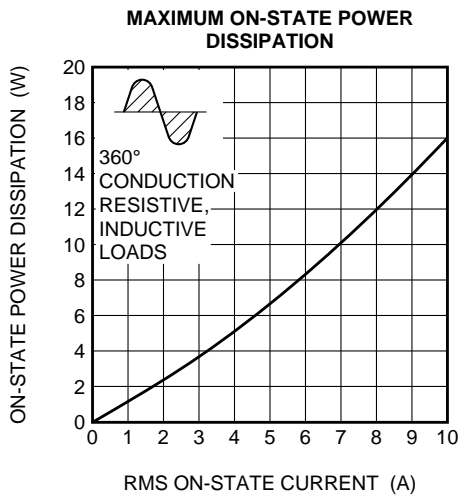
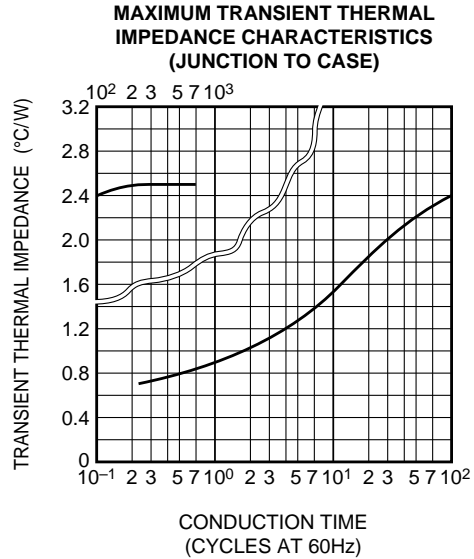
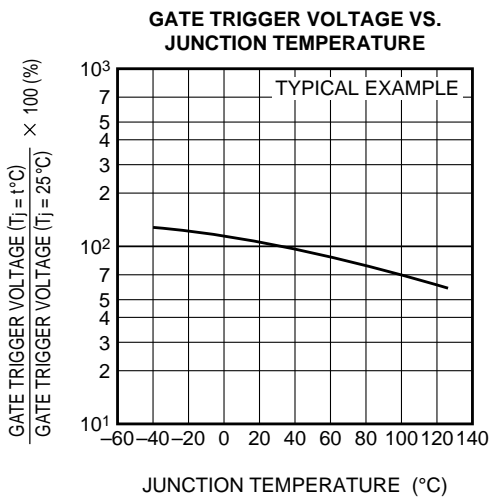
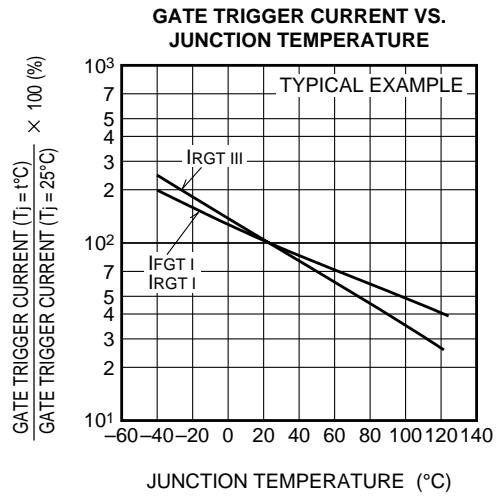
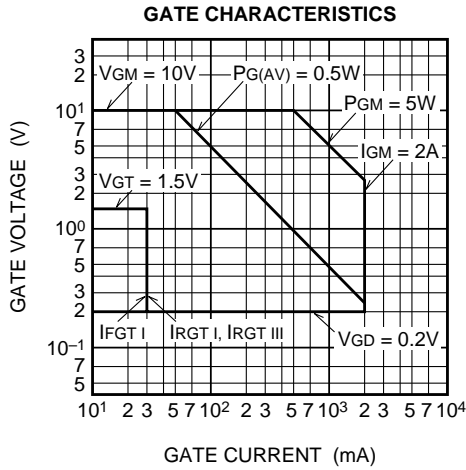

BCR6AM

MEDIUM POWER USE

NON-INSULATED TYPE, PLANAR PASSIVATION TYPE

ALLOWABLE AMBIENT TEMPERATURE VS. RMS ON-STATE CURRENT

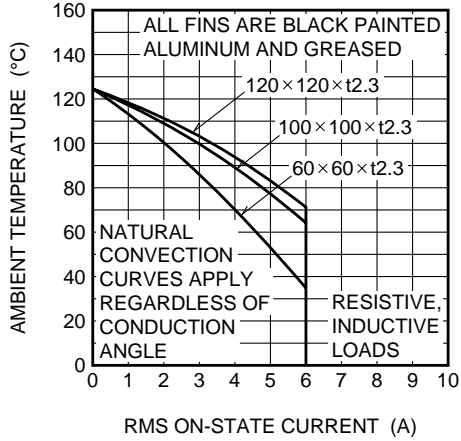

ALLOWABLE AMBIENT TEMPERATURE VS. RMS ON-STATE CURRENT

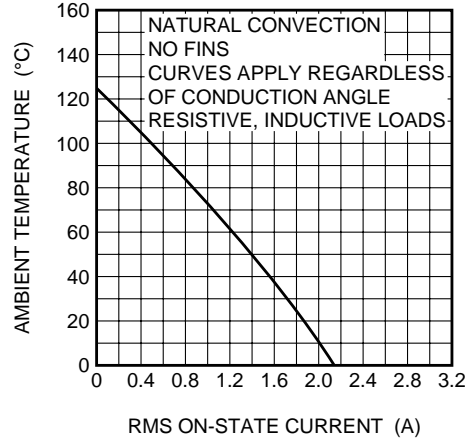

REPETITIVE PEAK OFF-STATE CURRENT VS. JUNCTION TEMPERATURE

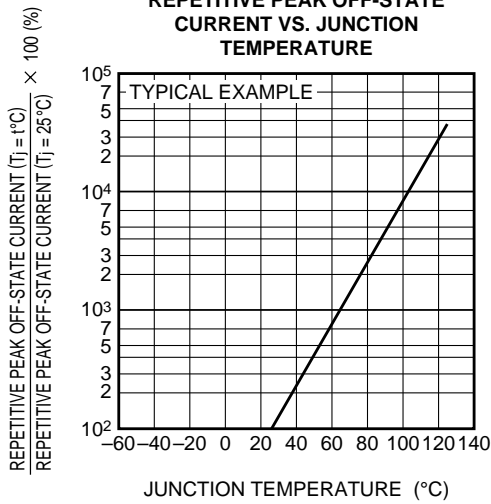

HOLDING CURRENT VS. JUNCTION TEMPERATURE

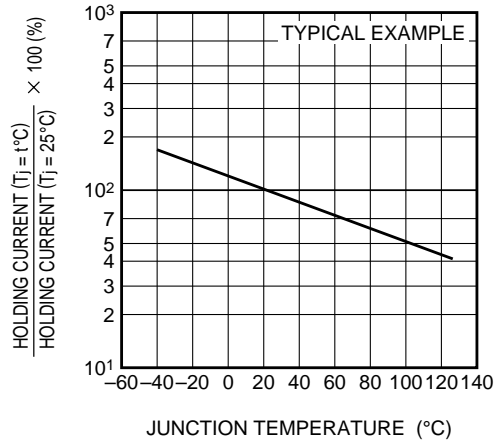

LACHING CURRENT VS. JUNCTION TEMPERATURE

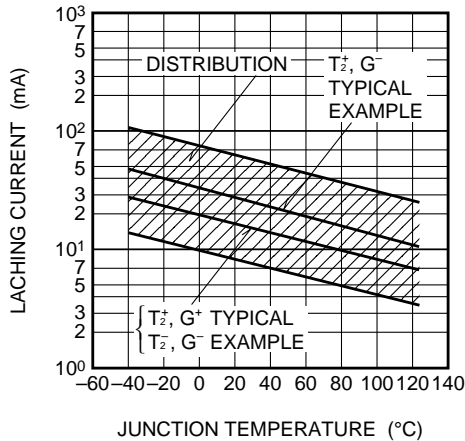

BREAKOVER VOLTAGE VS. JUNCTION TEMPERATURE

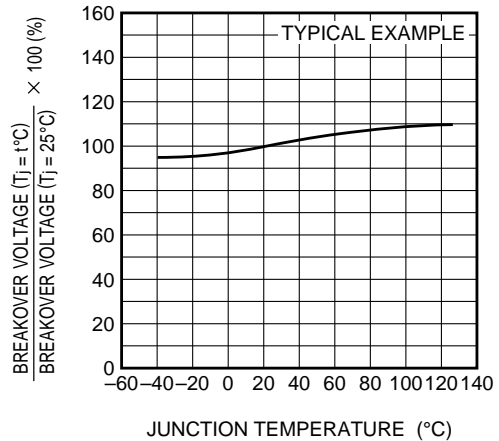

BCR6AM

MEDIUM POWER USE

NON-INSULATED TYPE, PLANAR PASSIVATION TYPE

BREAKOVER VOLTAGE VS. RATE OF RISE OF OFF-STATE VOLTAGE

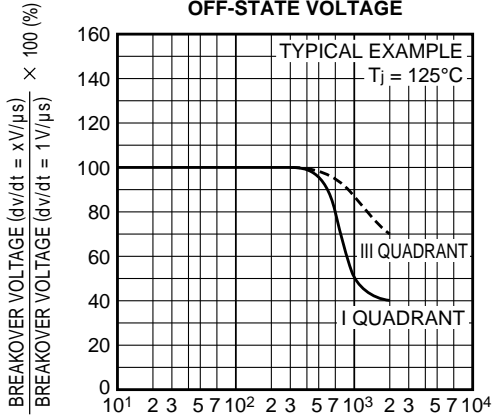

RATE OF RISE OF OFF-STATE VOLTAGE (V/μs)

COMMUTATION CHARACTERISTICS

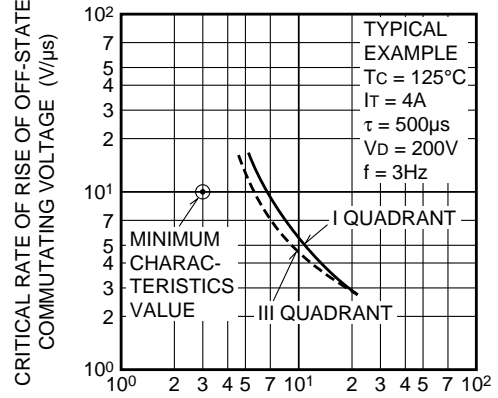

RATE OF DECAY OF ON-STATE COMMUTATING CURRENT (A/ms)

GATE TRIGGER CURRENT VS. GATE CURRENT PULSE WIDTH

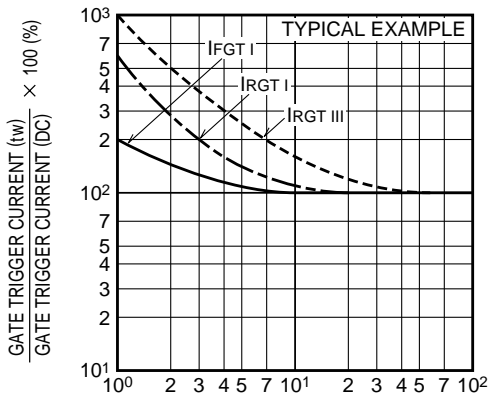

GATE CURRENT PULSE WIDTH (μs)

GATE TRIGGER CHARACTERISTICS TEST CIRCUITS

