

- ◆ P-Channel Power MOS FET
- ◆ DMOS Structure
- ◆ Low On-State Resistance: 0.19Ω MAX
- ◆ Ultra High-Speed Switching
- ◆ SOP-8 Package
- ◆ Two FET Devices built-in

General Description

The XP134A01A9SR is a P-Channel Power MOS FET with low on-state resistance and ultra high-speed switching characteristics. Two FET devices are built into the one package. Because high-speed switching is possible, the IC can be efficiently set thereby saving energy. The small SOP-8 package makes high density mounting possible.

Applications

- Notebook PCs
- Cellular and portable phones
- On-board power supplies
- Li-ion battery systems

Features

Low on-state resistance: $R_{ds(on)}=0.12\Omega(V_{gs}=-10V)$
 $R_{ds(on)}=0.19\Omega(V_{gs}=-4.5V)$

Ultra high-speed switching

Operational Voltage: -4.5V

High density mounting: SOP-8

Pin Configuration

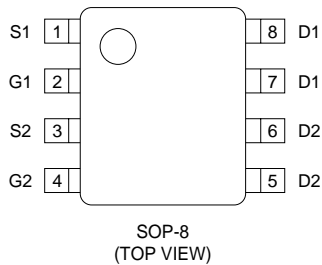

Pin Assignment

PIN NUMBER	PIN NAME	FUNCTION
1	S1	Source
2	G1	Gate
3	S2	Source
4	G2	Gate
5-6	D2	Drain
7-8	D1	Drain

Equivalent Circuit

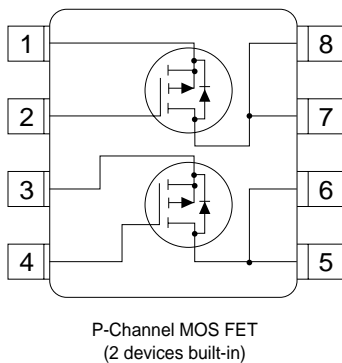

Absolute Maximum Ratings

$T_a=25^\circ\text{C}$

PARAMETER	SYMBOL	RATINGS	UNITS
Drain-Source Voltage	V_{dss}	-30	V
Gate-Source Voltage	V_{gss}	± 20	V
Drain Current (DC)	I_d	-3.5	A
Drain Current (Pulse)	I_{dp}	-10	A
Reverse Drain Current	I_{dr}	-3.5	A
Continuous Channel Power Dissipation (note)	P_d	2	W
Channel Temperature	T_{ch}	150	$^\circ\text{C}$
Storage Temperature	T_{stg}	-55~150	$^\circ\text{C}$

Note: When implemented on a glass epoxy PCB

Electrical Characteristics

DC characteristics

Ta=25°C

PARAMETER	SYMBOL	CONDITIONS	MIN	TYP	MAX	UNITS
Drain Cut-off Current	I _{dss}	V _{ds} =-30V, V _{gs} =0V			-10	μA
Gate-Source Leakage Current	I _{gss}	V _{gs} =±20V, V _{ds} =0V			±1	μA
Gate-Source Cut-off Voltage	V _{gs(off)}	I _d =-1mA, V _{ds} =-10V	-1.0		-2.5	V
Drain-Source On-state Resistance (note)	R _{ds(on)}	I _d =-2A, V _{gs} =-10V		0.095	0.12	Ω
		I _d =-2A, V _{gs} =-4.5V		0.15	0.19	Ω
Forward Transfer Admittance (note)	Y _{fs}	I _d =-2A, V _{ds} =-10V		4		S
Body Drain Diode Forward Voltage	V _f	I _f =-3.5A, V _{gs} =0V		-0.85	-1.1	V

Note: Effective during pulse test.

Dynamic characteristics

Ta=25°C

PARAMETER	SYMBOL	CONDITIONS	MIN	TYP	MAX	UNITS
Input Capacitance	C _{iss}	V _{ds} =-10V, V _{gs} =0V f=1MHz		600		pF
Output Capacitance	C _{oss}			350		pF
Feedback Capacitance	C _{rss}			110		pF

7

Switching characteristics

Ta=25°C

PARAMETER	SYMBOL	CONDITIONS	MIN	TYP	MAX	UNITS	
Turn-on Delay Time	t _{d (on)}	V _{gs} =-5V, I _d =-2A V _{dd} =-10V		15		ns	
Rise Time	t _r			25		ns	
Turn-off Delay Time	t _{d (off)}				25		ns
Fall Time	t _f				15		ns

Thermal characteristics

PARAMETER	SYMBOL	CONDITIONS	MIN	TYP	MAX	UNITS
Thermal Resistance (channel-surroundings)	R _{th (ch-a)}	Implement on a glass epoxy resin PCB		62.5		°C/W

Electrical Characteristics

Drain Current vs. Drain /Source Voltage

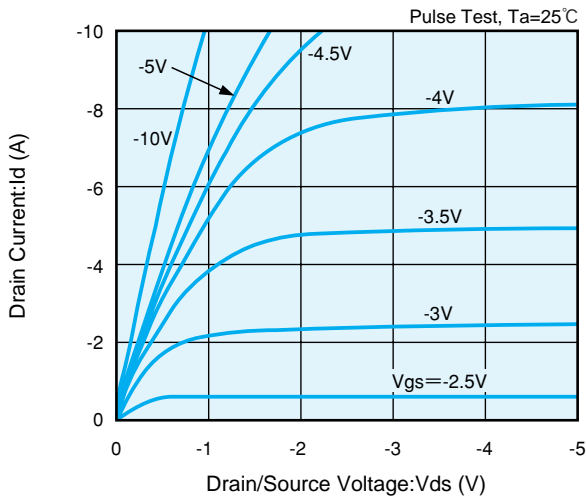

Drain Current vs. Gate/Source Voltage

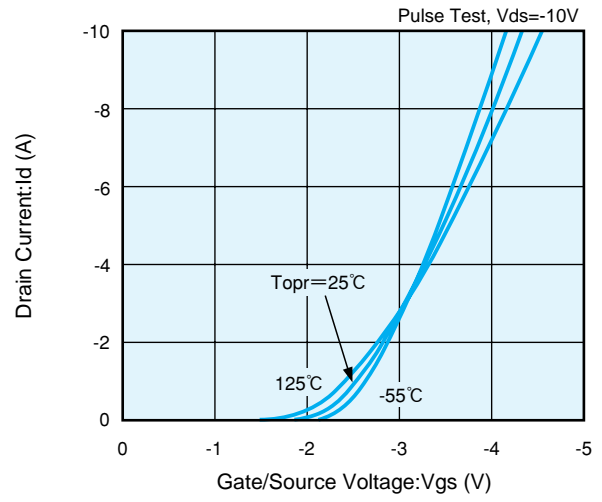

Drain/Source On-State Resistance vs. Gate/Source Voltage

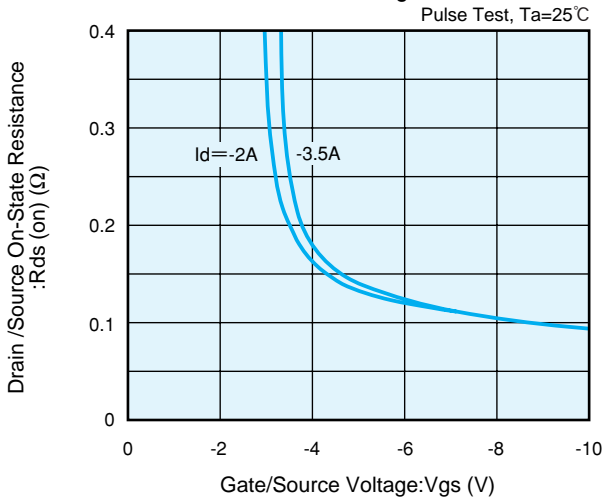

Drain/Source On-State Resistance vs. Drain Current

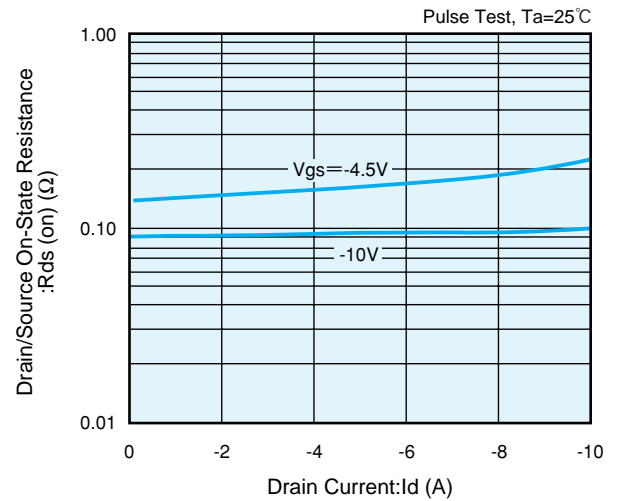

Drain/Source On-State Resistance vs. Ambient Temp.

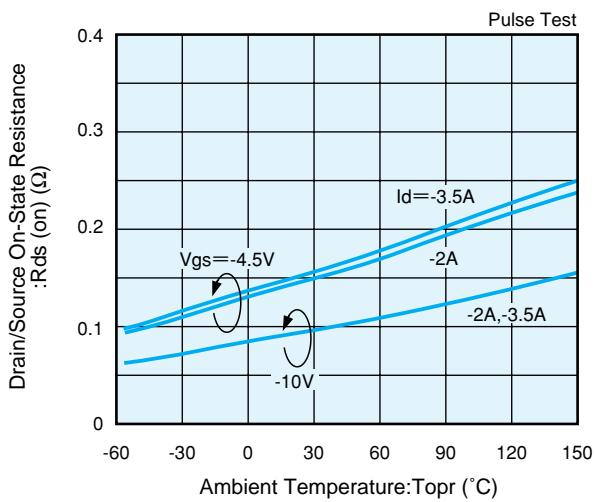

Gate/Source Cut Off Voltage Variance vs. Ambient Temp.

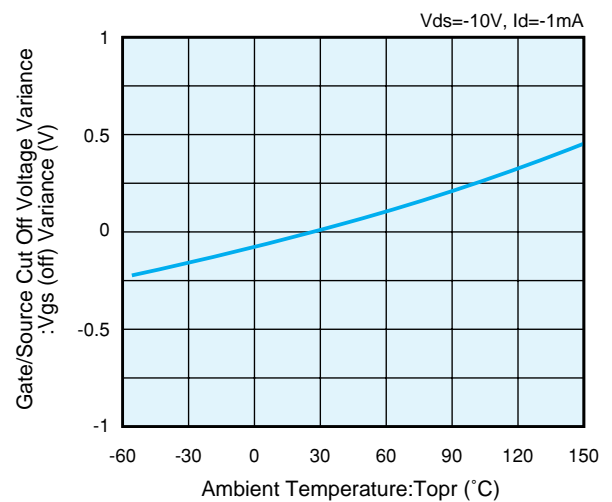

Electrical Characteristics

Drain/Source Voltage vs. Capacitance

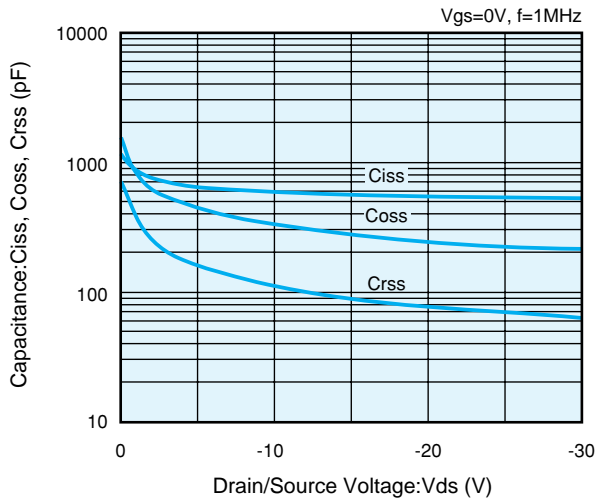

Switching Time vs. Drain Current

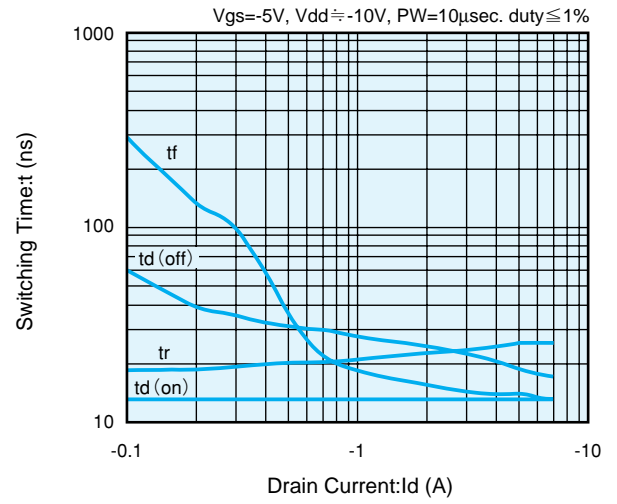

Gate/Source Voltage vs. Gate Charge

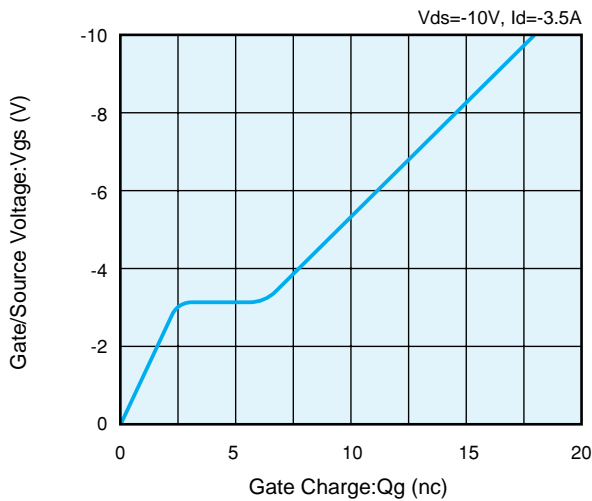

Reverse Drain Current vs. Source/Drain Voltage

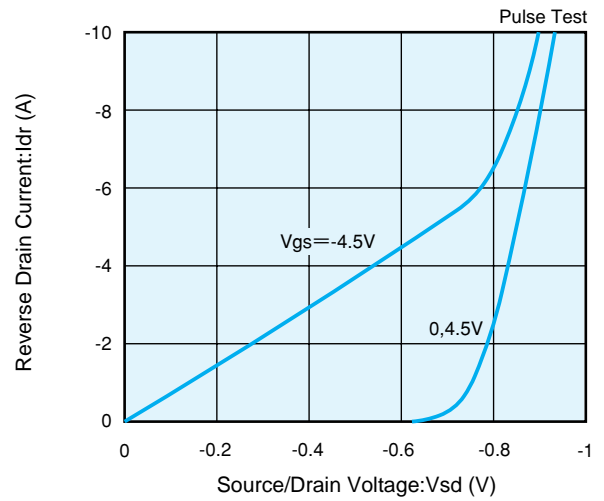

Standardized Transition Thermal Resistance vs. Pulse Width

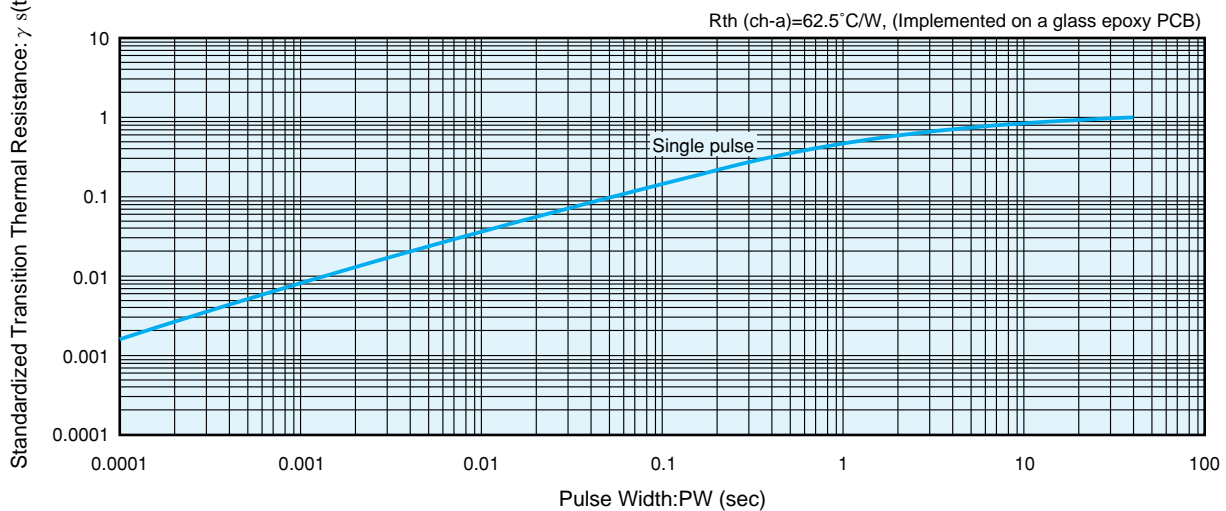

7