

HA13471A, HA13472A

Three-Phase Motor Drive with Speed Discriminator

Description

HA13471A and HA13472A are three-phase brushless DC motor drive IC of 2A/phase and 4A/phase and have following functions.

Features

- Soft switching (No spike voltage at commutation)
- Snubberless
- Large current capability
 - 2A/phase (HA13471A)
 - 4A/phase (HA13472A)
- High efficiency. Low noise driving

Functions

- Three phase output circuit
- Hall amp, Matrix with AGC
- Neutral point feed back
- Direction
- Output inhibit
- Oscillation circuit
- Mode select (1/4, 1/2, 1/1)
- Speed discriminator
- Integrator
- Control amp
- Current limiter
- Low voltage inhibit (LVI)
- Over temperature shutdown circuit (OTSD)

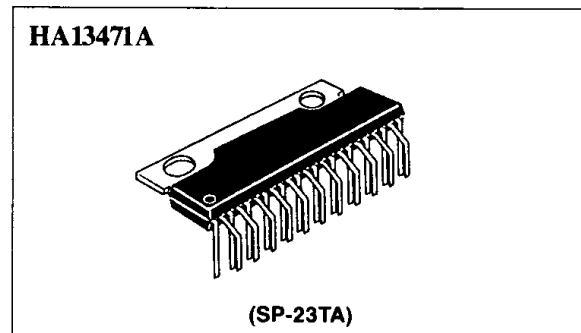

Pin Arrangement

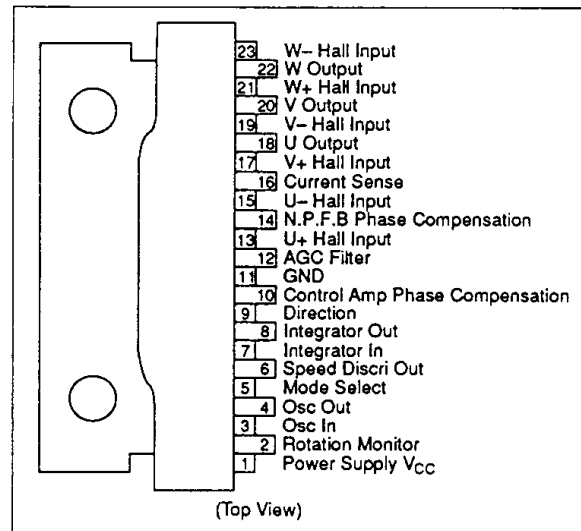

Ordering Information

Type No.	Package
HA13471A	SP-23TA
HA13472A	SP-23TA

Block Diagram

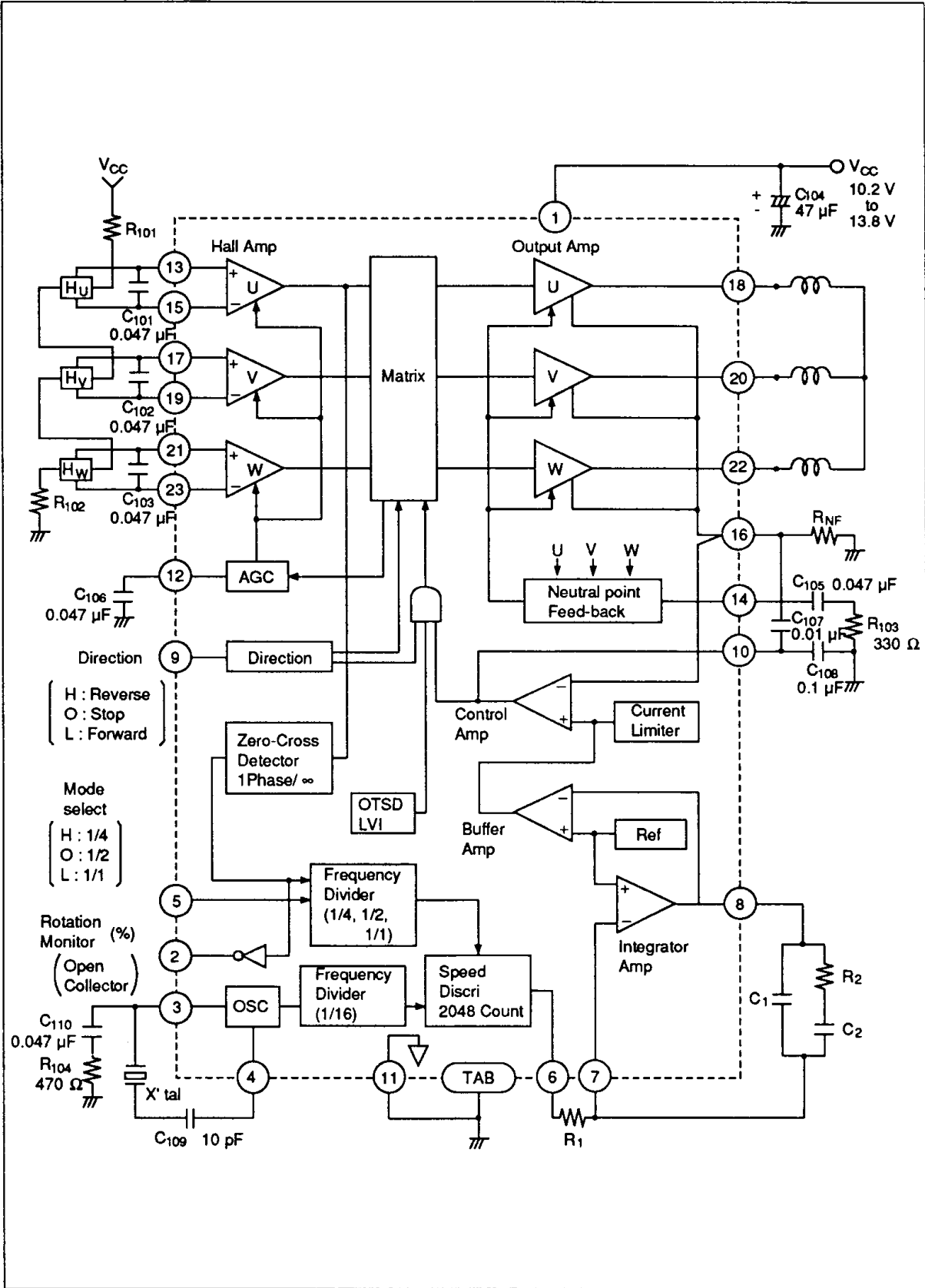

HA13471A, HA13472A

Absolute Maximum Ratings (Ta = 25°C)

Item	Symbol	Rating		Unit	Notes
		HA13471A	HA13472A		
Supply Voltage	V _{CC}	+15	+15	V	1
Input Voltage	V _{in}	V _{CC}	V _{CC}	V	2
Output Current	I _O	2	4	A	3
Power Dissipation	P _T	15 (at T _C = 105°C)	30 (at T _C = 60°C)	W	4
Junction Temperature	T _j	150	150	°C	5
Storage Temperature	T _{stg}	-55 to +125	-55 to +125	°C	

The absolute maximum ratings are limiting values, to be applied individually, beyond which the device may be permanently damaged. Functional operation under any of these conditions is not guaranteed. Exposing a circuit to its absolute maximum rating for extended periods of time may affect the device's reliability.

- Notes:
1. Operating voltage range is 12 V ±15% (10.2 ~ 13.8 V)
 2. Applied to Hall amp, Direction and Mode select Input
 3. ASO of each power transistor is shown below. Operating locus must be within the ASO

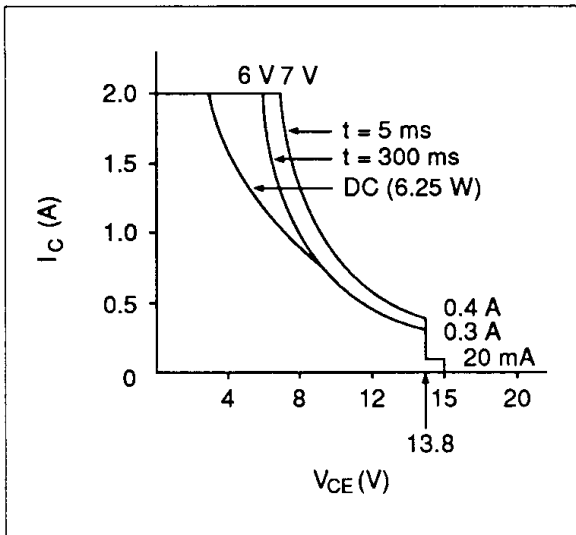

Figure 1 HA13471A

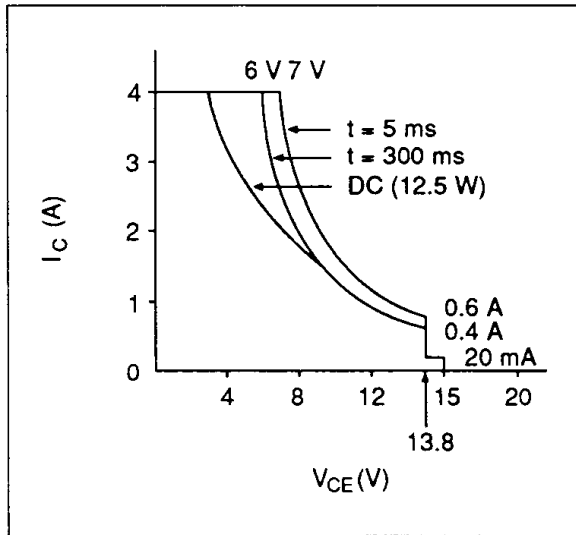

Figure 2 HA13472A

4. Thermal resistance is shown below
 - $\theta_{j-c} \leq 3^\circ\text{C/W}$
 - $\theta_{j-a} \leq 40^\circ\text{C/W}$
5. The operating junction temperature range is T_{opr} = 0°C to 125°C

Electrical Characteristics (Ta = 25°C, VCC = 12 V)

Item	Symbol	Min	Typ	Max	Unit	Test Conditions	Pins	Notes	
Dissipation current	I_{CC}	—	22	33	mA		1		
Hall amp	Input impedance	R_{Hi}	7	10	15	k Ω	13, 15, 17,		
	Common mode voltage range	V_H	2.5	—	V_{CC} -2.5	V	19, 21, 23	4	
	Differential voltage range	v_h	75	—	300	mV			
Output amp	Leak current	I_{CER}	—	—	2	mA	$V_{CE} = 15 V$	18, 20, 22	
	Saturation voltage	V_{sat1}	—	2.8	3.2	V	$I_O = 3.0 A (1.5 A)$		1
		V_{sat2}	—	1.7	2.0	V	$I_O = 0.6 A (0.3 A)$		1
Current limiter	Internal reference voltage	V_{ref1}	0.225	0.25	0.275	V	$R_{NF} = 1.0 \Omega$	16	
Buffer amp	Internal reference voltage	V_{ref2}	$V_{CC}/2$ -10%	$V_{CC}/2$	$V_{CC}/2$ +10%	V		7	
	Voltage gain	G_{CTL}	-2	0	+2	dB	Pin 8 to Pin 16	16	
Integrating amp	Input bias current	$I_B(ER)$	—	—	± 60	nA		7	
	Voltage swing	A ⁺	0.55	0.7	0.85	V	$I_O = 0.5 mA$	8	2
		A ⁻	-0.55	-0.7	-0.85	V	$I_O = -0.5 mA$		2
	Band width	BW	—	1.4	—	MHz	$G_V = 0 dB$		3
Speed discriminator	Output high voltage	V_{OH}	V_{CC} -0.3	—	—	V	$I_O = 0.5 mA$	6	
	Output low voltage	V_{OL}	—	—	0.2	V	$I_O = -0.5 mA$		
	Cutoff current	I_{off}	—	—	± 60	nA			
	Count number		—	2048	—				
Oscillator	Frequency error	f_{err}	—	—	± 0.1	%	X ^{1al} $f_{osc} = 8.0 MHz$	4	
	Operating frequency	f_{osc}	—	—	8	MHz	X ^{1al}		
Direction	Input high voltage	V_{IH}	3.6	—	—	V	Reverse	9	
	Input middle voltage	V_{IM}	2.2	—	2.8	V	Stop		
	Input low voltage	V_{IL}	—	—	1.4	V	Forward		
	Input high current	I_{IH}	—	0.54	0.8	mA	$V_H = 5.5 V$		
	Input low current	I_{IL}	—	-0.54	-0.8	mA	$V_L = 0.0 V$		
Driver	Input high voltage	V_{IH2}	3.6	—	—	V	Ratio; 1/4	5	
	Input middle voltage	V_{IN2}	2.2	—	2.8	V	Ratio; 1/2		
	Input low voltage	V_{IL2}	—	—	1.4	V	Ratio; 1/1		
	Input high current	I_{IH2}	—	0.54	0.8	mA	$V_{H2} = 5.5 V$		
	Input low current	I_{IL2}	—	-0.54	-0.8	mA	$V_{L2} = 0.0 V$		

HA13471A, HA13472A

Electrical Characteristics (Ta = 25°C, VCC = 12 V) (cont)

Item		Symbol	Min	Typ	Max	Unit	Test Conditions	Pins	Notes
Rotation monitor	Output leak current	I_{CER2}	—	—	100	μA	$V_{CE} = 15 V$	2	
	Output low voltage	V_{OL2}	—	—	0.4	V	$I_O = 1 mA$		
LVI operating voltage			—	—	8.0	V			
OTSD operating temperature		T_{sd}	125	150	—	°C			3

- Notes:
1. Sum of upper and lower saturation voltage.
 2. Measure from V_{ref2}
 3. Design guide only
 4. Operating area for V_H and v_h is shown below

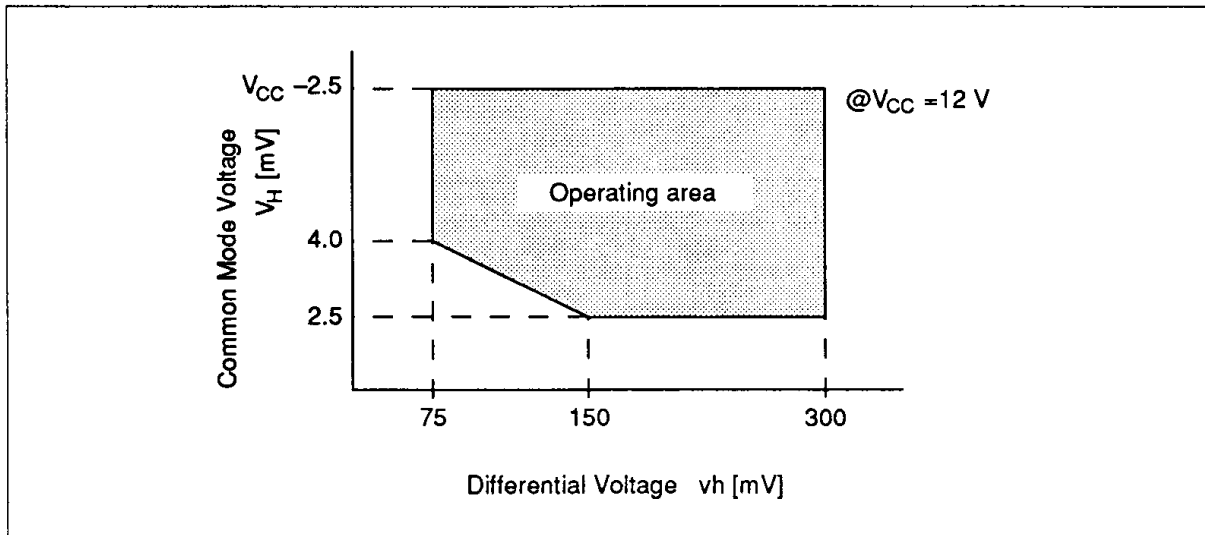
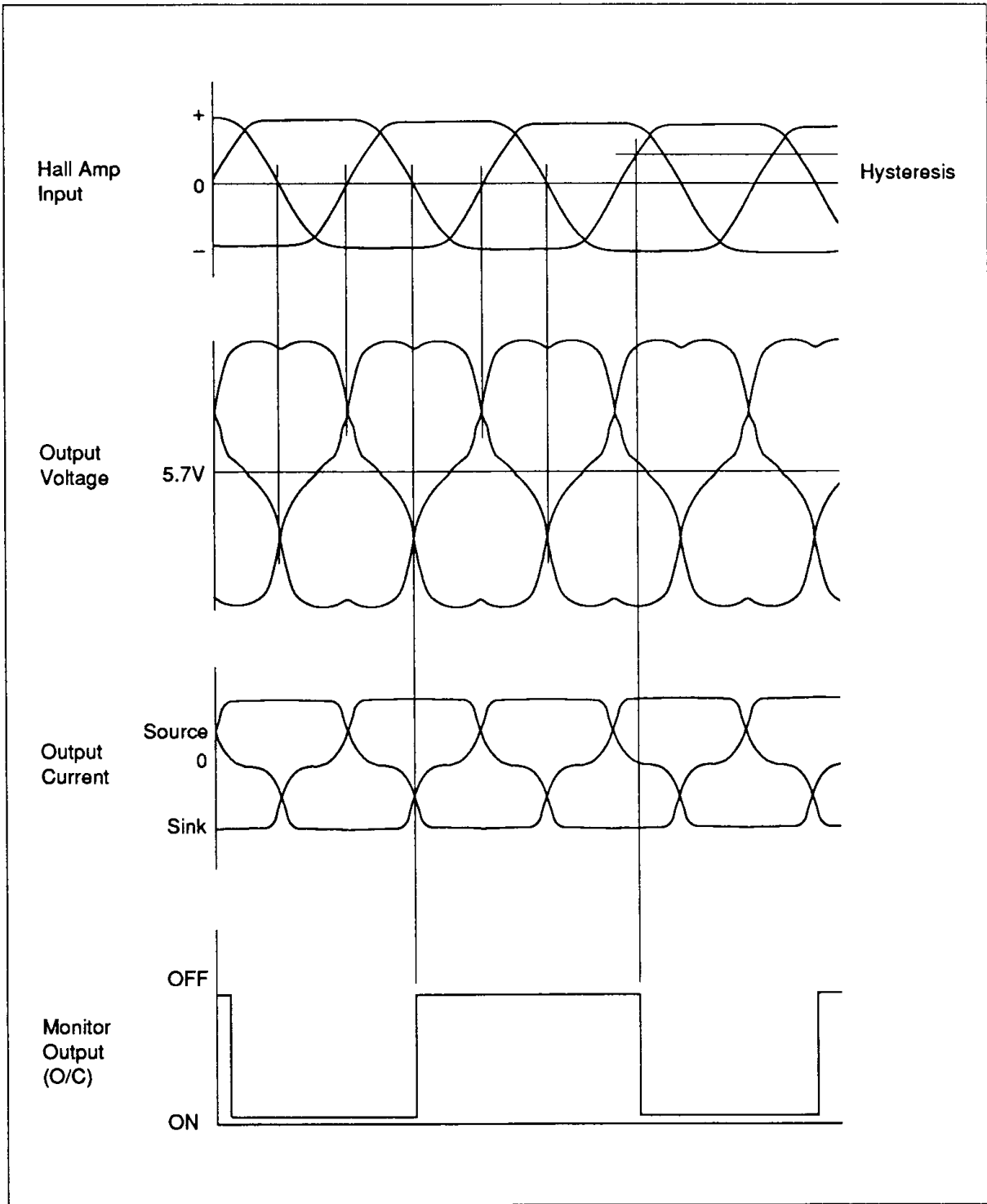

Figure 3 Hallamp Operating Area

Timing Chart



HA13471A, HA13472A

External Components

Parts No.	Recommended value		Purpose	Notes
	HA13471A 3.5" × 2 disks	HA13472A 5.25" × 6 disks		
R ₁₀₁ , R ₁₀₂	560 Ω	560 Ω	Hall element bias	1
R ₁₀₃	330 Ω	330 Ω	Stability	
R ₁₀₄	470 Ω	470 Ω	Oscillation stability	2
R ₁	470 kΩ	68 kΩ	Integral constant	3
R ₂	560 kΩ	560 kΩ		
R _{NF}	0.33 Ω × 2 para	0.33 Ω × 4 para	Current detector	4
C ₁₀₁ , C ₁₀₂ , C ₁₀₃	0.047 μF	0.047 μF	Stability	
C ₁₀₄	≥ 47 μF	≥ 47 μF	By-pass	
C ₁₀₅	0.047 μF	0.047 μF	NPF phase compensation	
C ₁₀₆	0.047 μF	0.047 μF	AGC filter	
C ₁₀₇	0.01 μF	0.01 μF	CTL Amp	
C ₁₀₈	0.1 μF	0.1 μF	Phase compensation	
C ₁₀₉	10 pF ±1%	10 pF ±1%	AC-coupling	
C ₁₁₀	0.047 μF	0.047 μF	Stability	2
C ₁	0.022 μF	0.022 μF	Integral constant	3
C ₂	0.22 μF	0.22 μF		
D ₁ , D ₂ , D ₃	—	—	Output clamp	5
X ^{tal}	—	—	Oscillator	6

- Notes:
1. Set R₁₀₁, R₁₀₂ in order to get Hall element output within 75 to 300 mV_{pp}
 2. Unnecessary below 4 MHz frequency
 3. The optimum value depends on the motor (Inertia, Torque constant Rotation)
 4. Output Current is limited as shown below

$$I_{omax} = V_{ref1}/R_{NF}$$
 5. It must be noted that some motors requires protection for speed discriminator misoperation
 6. OSC frequency f_{osc} is determined by following equation

$$f_{osc} = \frac{16 \times 2048 \times f_H}{m}$$

$$= \frac{16 \times 2048}{m} \times \frac{No}{60} \times \frac{P}{2} \text{ (Hz)}$$

Where

f _H	:	frequency of hall amp input signal
No	:	rotation Number
P	:	pole Number
m	:	frequency divider constant
		m = 1 (@ Pin 5 = Low)
		= 2 (@ Pin 5 = Open)
		= 4 (@ Pin 5 = High)

In case of large jitter of hall amp input signal, select divider constant m as follows

4 pole motor → m = 2

8 pole motor → m = 4

