



STN2NE06

N-CHANNEL 60V - 0.18Ω - 2A - SOT-223 STripFET™ POWER MOSFET

TYPE	V _{DSS}	R _{DS(on)}	I _D
STN2NE06	60 V	< 0.25 Ω	2 A

- TYPICAL R_{DS(on)} = 0.18 Ω
- EXCEPTIONAL dv/dt CAPABILITY
- AVALANCHE RUGGED TECHNOLOGY
- 100 % AVALANCHE TESTED
- APPLICATION ORIENTED CHARACTERIZATION

DESCRIPTION

This Power Mosfet is the latest development of STMicroelectronics unique "Single Feature Size™" stip-based process. The resulting transistor shows extremely high packing density for low on-resistance, rugged avalanche characteristics and less critical alignment steps therefore a remarkable manufacturing reproducibility.

APPLICATIONS

- DC MOTOR CONTROL (DISK DRIVES, etc.)
- DC-DC & DC-AC CONVERTERS
- SYNCHRONOUS RECTIFICATION

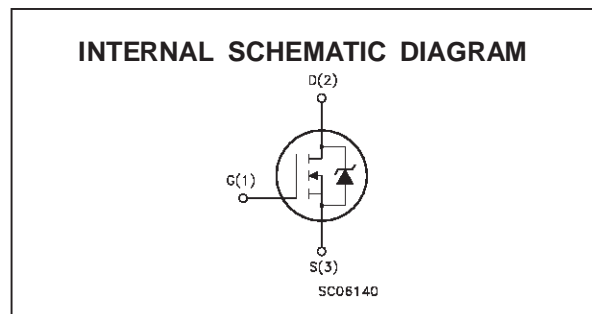
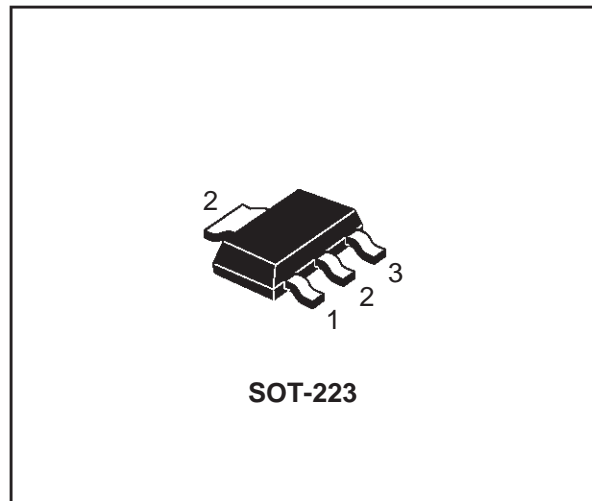

ABSOLUTE MAXIMUM RATINGS

Symbol	Parameter	Value	Unit
V _{DS}	Drain-source Voltage (V _{GS} = 0)	60	V
V _{DGR}	Drain- gate Voltage (R _{GS} = 20 kΩ)	60	V
V _{GS}	Gate-source Voltage	± 20	V
I _D	Drain Current (continuous) at T _c = 25 °C	2	A
I _D	Drain Current (continuous) at T _c = 100 °C	1.3	A
I _{DM} (•)	Drain Current (pulsed)	8	A
P _{tot}	Total Dissipation at T _c = 25 °C	2.5	W
	Derating Factor	0.02	W/°C
dv/dt(1)	Peak Diode Recovery voltage slope	6	V/ns
T _{stg}	Storage Temperature	-65 to 150	°C
T _j	Max. Operating Junction Temperature	150	°C

(•) Pulse width limited by safe operating area

(1) I_{SD} ≤ 8 A, di/dt ≤ 200 A/μs, V_{DD} ≤ V_{(BR)DSS}, T_j ≤ T_{JMAX}

STN2NE06

THERMAL DATA

$R_{thj-pcb}$	Thermal Resistance Junction-PC Board	Max	50	$^{\circ}\text{C}/\text{W}$
$R_{thj-amb}$	Thermal Resistance Junction-ambient (Surface Mounted)	Max	60	$^{\circ}\text{C}/\text{W}$
T_l	Maximum Lead Temperature For Soldering Purpose		260	$^{\circ}\text{C}$

AVALANCHE CHARACTERISTICS

Symbol	Parameter	Max Value	Unit
I_{AR}	Avalanche Current, Repetitive or Not-Repetitive (pulse width limited by T_j max)	2	A
E_{AS}	Single Pulse Avalanche Energy (starting $T_j = 25^{\circ}\text{C}$, $I_D = I_{AR}$, $V_{DD} = 25\text{ V}$)	20	mJ

ELECTRICAL CHARACTERISTICS ($T_{case} = 25^{\circ}\text{C}$ unless otherwise specified)

OFF

Symbol	Parameter	Test Conditions	Min.	Typ.	Max.	Unit
$V_{(BR)DSS}$	Drain-source Breakdown Voltage	$I_D = 250\ \mu\text{A}$ $V_{GS} = 0$	60			V
I_{DSS}	Zero Gate Voltage Drain Current ($V_{GS} = 0$)	$V_{DS} = \text{Max Rating}$ $V_{DS} = \text{Max Rating}$ $T_c = 125^{\circ}\text{C}$			1 10	μA μA
I_{GSS}	Gate-body Leakage Current ($V_{DS} = 0$)	$V_{GS} = \pm 20\text{ V}$			± 100	nA

ON (*)

Symbol	Parameter	Test Conditions	Min.	Typ.	Max.	Unit
$V_{GS(th)}$	Gate Threshold Voltage	$V_{DS} = V_{GS}$ $I_D = 250\ \mu\text{A}$	2	3	4	V
$R_{DS(on)}$	Static Drain-source On Resistance	$V_{GS} = 10\text{ V}$ $I_D = 1\text{ A}$		0.18	0.25	Ω
$I_{D(on)}$	On State Drain Current	$V_{DS} > I_{D(on)} \times R_{DS(on)max}$ $V_{GS} = 10\text{ V}$	2			A

DYNAMIC

Symbol	Parameter	Test Conditions	Min.	Typ.	Max.	Unit
g_{fs} (*)	Forward Transconductance	$V_{DS} > I_{D(on)} \times R_{DS(on)max}$ $I_D = 1\text{ A}$		1.8		S
C_{iss}	Input Capacitance	$V_{DS} = 25\text{ V}$ $f = 1\text{ MHz}$ $V_{GS} = 0\text{ V}$		310	420	pF
C_{oss}	Output Capacitance			45	61	pF
C_{rss}	Reverse Transfer Capacitance			12.5	17	pF

ELECTRICAL CHARACTERISTICS (continued)

SWITCHING ON

Symbol	Parameter	Test Conditions	Min.	Typ.	Max.	Unit
$t_{d(on)}$	Turn-on Time	$V_{DD} = 30\text{ V}$ $I_D = 1\text{ A}$		9	13	ns
t_r	Rise Time	$R_G = 4.7\ \Omega$ $V_{GS} = 10\text{ V}$		10	13.5	ns
Q_g	Total Gate Charge	$V_{DD} = 40\text{ V}$ $I_D = 2\text{ A}$ $V_{GS} = 10\text{ V}$		12	17	nC
Q_{gs}	Gate-Source Charge			5.1	7	nC
Q_{gd}	Gate-Drain Charge			2.7	4	nC

SWITCHING OFF

Symbol	Parameter	Test Conditions	Min.	Typ.	Max.	Unit
$t_{r(voff)}$	Off-voltage Rise Time	$V_{DD} = 48\text{ V}$ $I_D = 2\text{ A}$		4.5	6	ns
t_f	Fall Time	$R_G = 4.7\ \Omega$ $V_{GS} = 10\text{ V}$		5	7	ns
t_c	Cross-over Time			12	16	ns

SOURCE DRAIN DIODE

Symbol	Parameter	Test Conditions	Min.	Typ.	Max.	Unit
I_{SD}	Source-drain Current				2	A
$I_{SDM}(\bullet)$	Source-drain Current (pulsed)				8	A
$V_{SD}(\ast)$	Forward On Voltage	$I_{SD} = 2\text{ A}$ $V_{GS} = 0$			1.2	V
t_{rr}	Reverse Recovery Time	$I_{SD} = 2\text{ A}$ $di/dt = 100\text{ A}/\mu\text{s}$ $V_{DD} = 30\text{ V}$ $T_j = 150\text{ }^\circ\text{C}$		40		ns
Q_{rr}	Reverse Recovery Charge			50		nC
I_{RRM}	Reverse Recovery Current			2.5		A

(*) Pulsed: Pulse duration = 300 μs , duty cycle 1.5 %

(•) Pulse width limited by safe operating area

Safe Operating Area

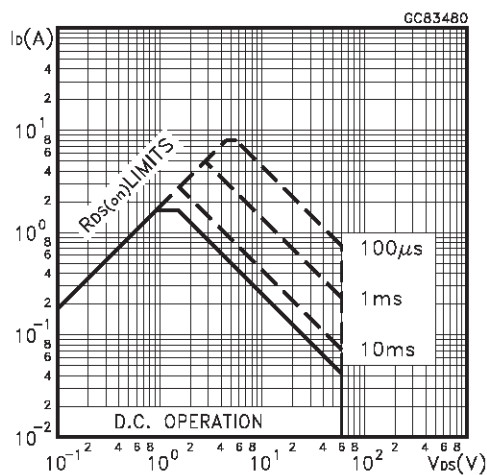

Thermal Impedance

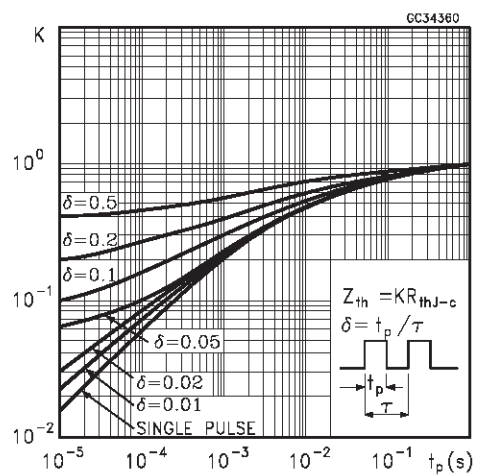

Output Characteristics

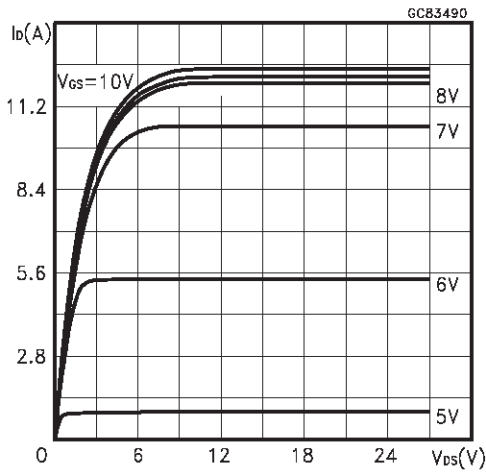

Transfer Characteristics

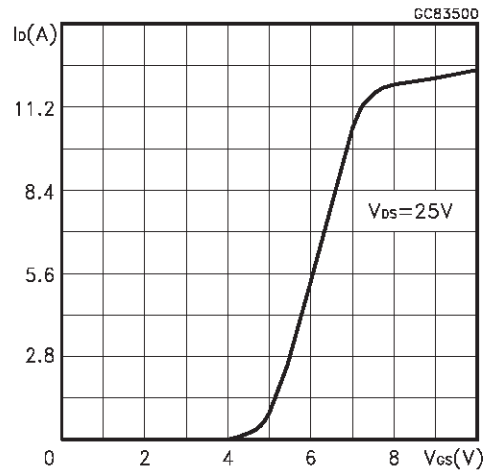

Transconductance

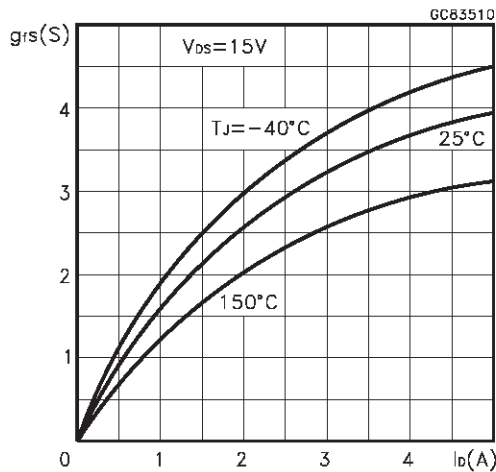

Static Drain-source On Resistance

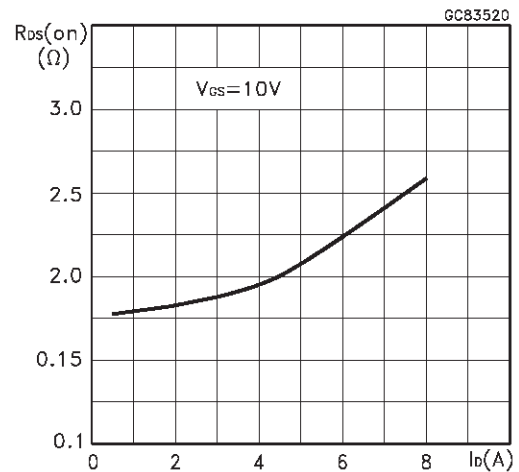

Gate Charge vs Gate-source Voltage

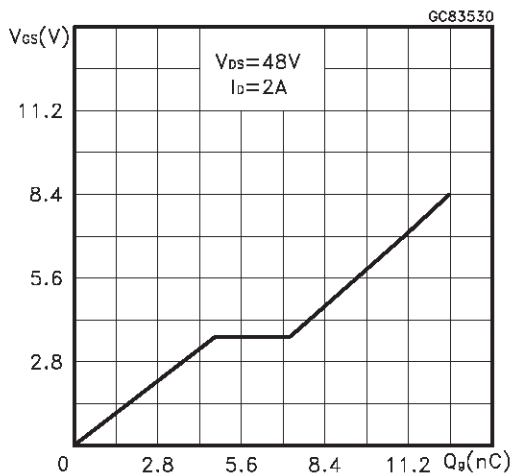

Capacitance Variations

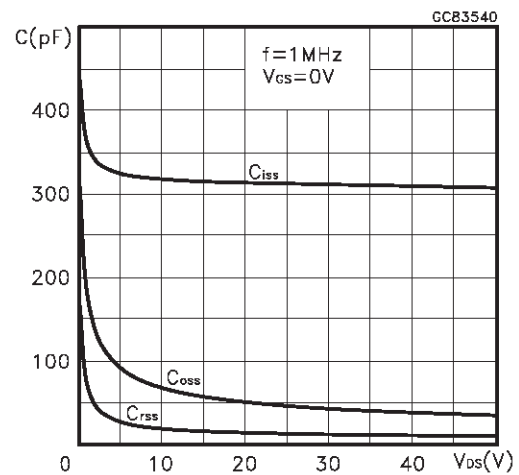

Normalized Gate Threshold Voltage vs Temperature

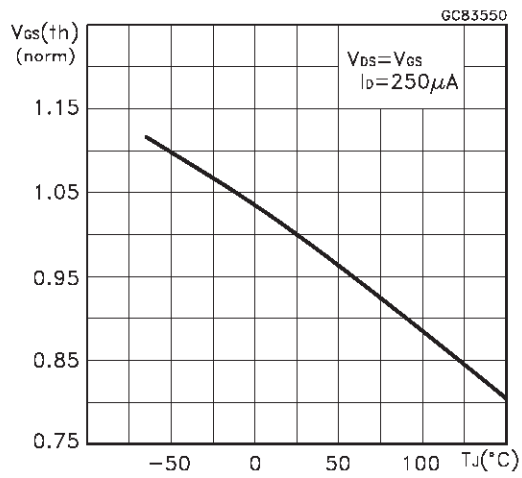

Normalized On Resistance vs Temperature

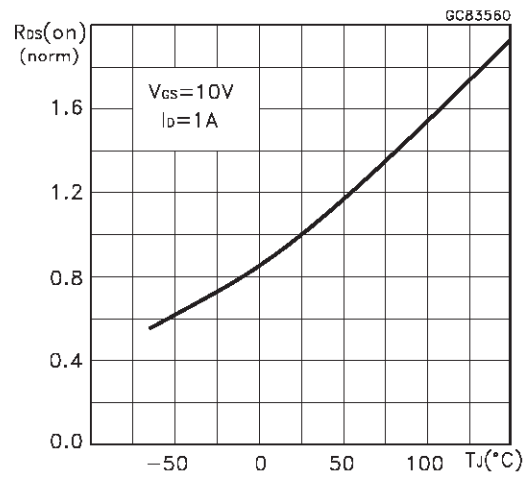

Source-drain Diode Forward Characteristics

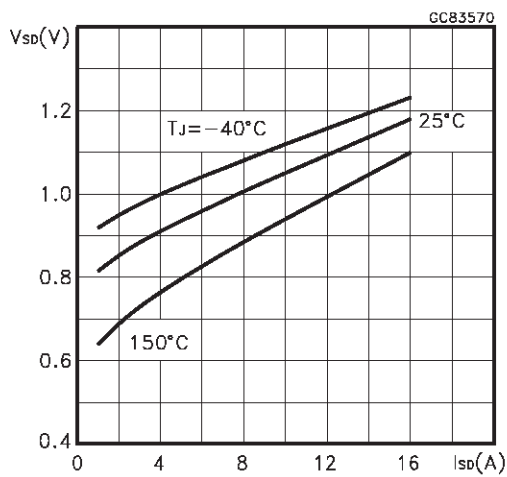

Fig. 1: Unclamped Inductive Load Test Circuit



Fig. 2: Unclamped Inductive Waveform



Fig. 3: Switching Times Test Circuits For Resistive Load



Fig. 4: Gate Charge test Circuit

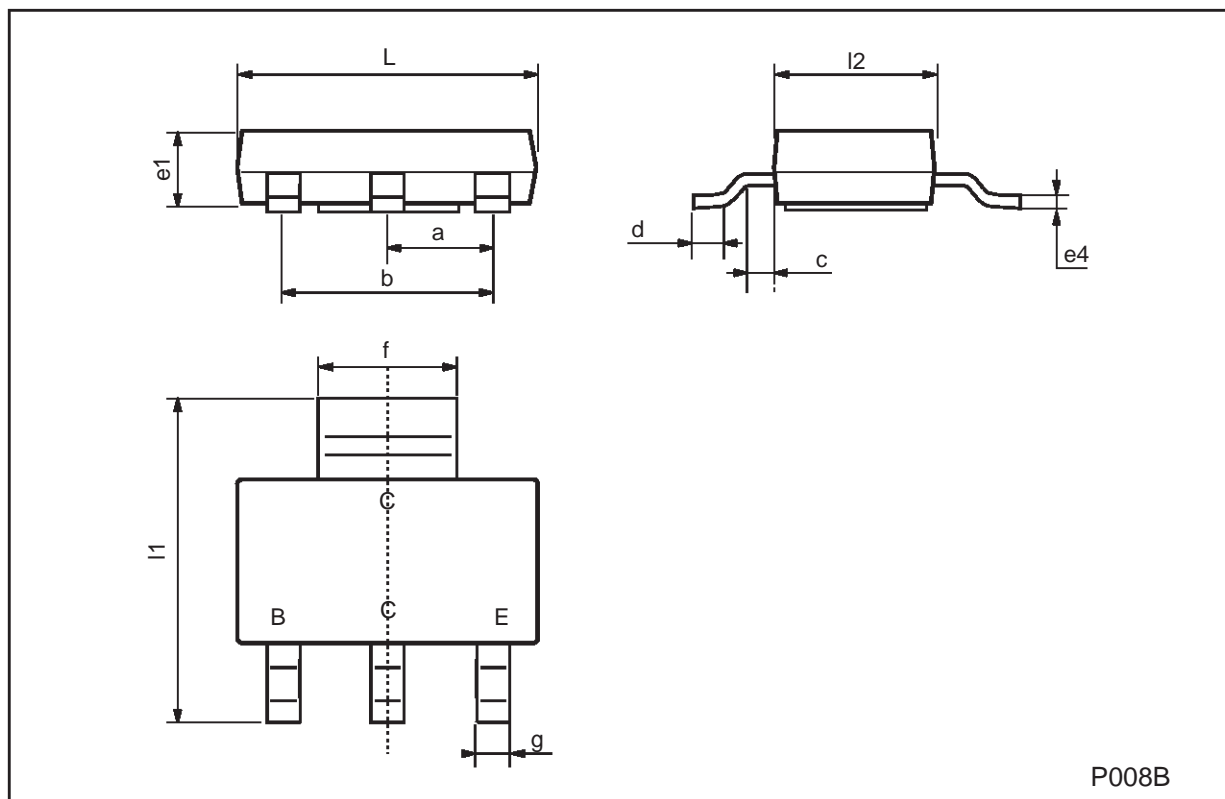

Fig. 5: Test Circuit For Inductive Load Switching And Diode Recovery Times



SOT-223 MECHANICAL DATA

DIM.	mm			mils		
	MIN.	TYP.	MAX.	MIN.	TYP.	MAX.
a	2.27	2.3	2.33	89.4	90.6	91.7
b	4.57	4.6	4.63	179.9	181.1	182.3
c	0.2	0.4	0.6	7.9	15.7	23.6
d	0.63	0.65	0.67	24.8	25.6	26.4
e1	1.5	1.6	1.7	59.1	63	66.9
e4			0.32			12.6
f	2.9	3	3.1	114.2	118.1	122.1
g	0.67	0.7	0.73	26.4	27.6	28.7
l1	6.7	7	7.3	263.8	275.6	287.4
l2	3.5	3.5	3.7	137.8	137.8	145.7
L	6.3	6.5	6.7	248	255.9	263.8



Information furnished is believed to be accurate and reliable. However, STMicroelectronics assumes no responsibility for the consequences of use of such information nor for any infringement of patents or other rights of third parties which may result from its use. No license is granted by implication or otherwise under any patent or patent rights of STMicroelectronics. Specification mentioned in this publication are subject to change without notice. This publication supersedes and replaces all information previously supplied. STMicroelectronics products are not authorized for use as critical components in life support devices or systems without express written approval of STMicroelectronics.

The ST logo is a trademark of STMicroelectronics

© 1999 STMicroelectronics – Printed in Italy – All Rights Reserved
STMicroelectronics GROUP OF COMPANIES

Australia - Brazil - Canada - China - France - Germany - Italy - Japan - Korea - Malaysia - Malta - Mexico - Morocco - The Netherlands - Singapore - Spain - Sweden - Switzerland - Taiwan - Thailand - United Kingdom - U.S.A.