

5V/3.3V 256K × 16 CMOS SRAM

Features

- AS7C4098 (5V version)
- AS7C34098 (3.3V version)
- Industrial and commercial temperature
- Organization: 262,144 words × 16 bits
- Center power and ground pins
- High speed
 - 10/12/15/20 ns address access time
 - 5/6/7/9 ns output enable access time
- Low power consumption: ACTIVE
 - 1375 mW (AS7C4098)/max @ 12 ns
 - 468 mW (AS7C34098)/max @ 12 ns
- Low power consumption: STANDBY
 - 110 mW (AS7C4098)/max CMOS
 - 72 mW (AS7C34098)/max CMOS
- Individual byte read/write controls
- 2.0V data retention
- Easy memory expansion with \overline{CE} , \overline{OE} inputs
- TTL- and CMOS-compatible, three-state I/O
- 44-pin JEDEC standard packages
 - 400-mil SOJ
 - 400-mil TSOP II
- ESD protection ≥ 2000 volts
- Latch-up current ≥ 200 mA

Logic block diagram

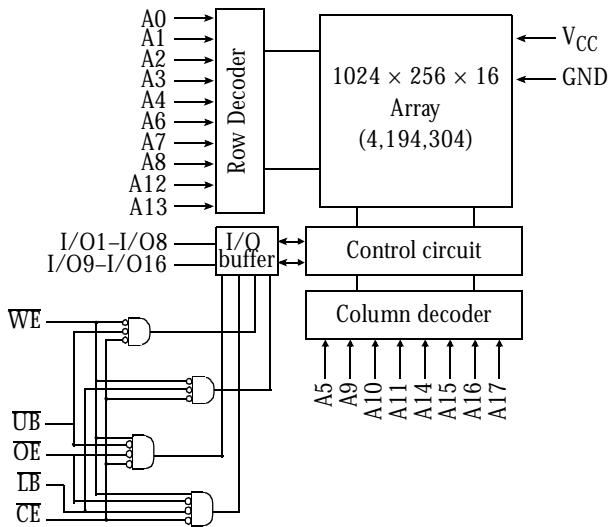

Pin arrangement

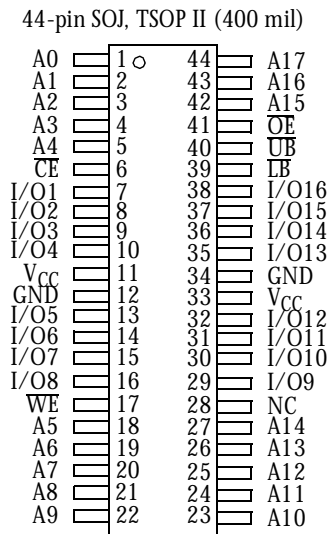

Selection guide

		AS7C34098 -10	AS7C4098 AS7C34098 -12	AS7C4098 AS7C34098 -15	AS7C4098 AS7C34098 -20	Unit
Maximum address access time		10	12	15	20	ns
Maximum output enable access time		5	6	7	9	ns
Maximum operating current	AS7C4098	-	250	220	180	mA
	AS7C34098	160	130	110	100	mA
Maximum CMOS standby current	AS7C4098	-	20	20	20	mA
	AS7C34098	20	20	20	20	mA

Shaded areas indicate preliminary information.

AS7C4098 AS7C34098



Functional description

The AS7C4098 and AS7C34098 are high-performance CMOS 4,194,304-bit Static Random Access Memory (SRAM) devices organized as 262,144 words \times 16 bits. They are designed for memory applications where fast data access, low power, and simple interfacing are desired.

Equal address access and cycle times (t_{AA} , t_{RC} , t_{WC}) of 10/12/15/20 ns with output enable access times (t_{OE}) of 5/6/7/9 ns are ideal for high-performance applications. The chip enable input \overline{CE} permits easy memory expansion with multiple-bank memory systems.

When \overline{CE} is High the device enters standby mode. The standard AS7C4098 is guaranteed not to exceed 110 mW power consumption in CMOS standby mode. Both devices offer 2.0V data retention.

A write cycle is accomplished by asserting write enable (\overline{WE}) and chip enable (\overline{CE}). Data on the input pins I/O1–I/O16 is written on the rising edge of \overline{WE} (write cycle 1) or \overline{CE} (write cycle 2). To avoid bus contention, external devices should drive I/O pins only after outputs have been disabled with output enable (\overline{OE}) or write enable (\overline{WE}).

A read cycle is accomplished by asserting output enable (\overline{OE}) and chip enable (\overline{CE}), with write enable (\overline{WE}) High. The chip drives I/O pins with the data word referenced by the input address. When either chip enable or output enable is inactive, or write enable is active, output drivers stay in high-impedance mode.

These devices provide multiple center power and ground pins, and separate byte enable controls, allowing individual bytes to be written and read. \overline{LB} controls the lower bits, I/O1–I/O8, and \overline{UB} controls the higher bits, I/O9–I/O16.

All chip inputs and outputs are TTL- and CMOS-compatible, and operation is from either a single 5V (AS7C4098) or 3.3V (AS7C34098) supply. Both devices are available in the JEDEC standard 400-mL, 44-pin SOJ and TSOP II packages.

Absolute maximum ratings

Parameter	Device	Symbol	Min	Max	Unit
Voltage on V_{CC} relative to GND	AS7C4098	V_{t1}	-0.50	+7.0	V
	AS7C34098	V_{t1}	-0.50	+5.0	V
Voltage on any pin relative to GND		V_{t2}	-0.50	$V_{CC} + 0.50$	V
Power dissipation		P_D	-	1.5	W
Storage temperature (plastic)		T_{stg}	-65	+150	$^{\circ}C$
Ambient temperature with V_{CC} applied		T_{bias}	-55	+125	$^{\circ}C$
DC current into outputs (low)		I_{OUT}	-	± 20	mA

Note: Stresses greater than those listed under Absolute Maximum Ratings may cause permanent damage to the device. This is a stress rating only and functional operation of the device at these or any other conditions outside those indicated in the operational sections of this specification is not implied. Exposure to absolute maximum rating conditions for extended periods may affect reliability.

Truth table

\overline{CE}	\overline{WE}	\overline{OE}	\overline{LB}	\overline{UB}	I/O1–I/O8	I/O9–I/O16	Mode
H	X	X	X	X	High Z	High Z	Standby (I_{SB} , I_{SB1})
L	H	H	X	X	High Z	High Z	Output disable (I_{CC})
L	X	X	H	H			
L	H	L	L	H	D_{OUT}	High Z	Read (I_{CC})
			H	L	High Z	D_{OUT}	
			L	L	D_{OUT}	D_{OUT}	
L	L	X	L	H	D_{IN}	High Z	Write (I_{CC})
			H	L	High Z	D_{IN}	
			L	L	D_{IN}	D_{IN}	

Key: X = Don't care, L = Low, H = High.



Recommended operating conditions

Parameter		Symbol	Min	Typical	Max	Unit
Supply voltage	AS7C4098	V_{CC} (10/12/15/20)	4.5	5.0	5.5	V
	AS7C34098	V_{CC} (-10)	3.15	3.3	3.6	V
	AS7C34098	V_{CC} (10/12/15/20)	3.0	3.3	3.6	V
Input voltage	AS7C4098	V_{IH}	2.2	-	$V_{CC} + 0.5$	V
	AS7C34098	V_{IH}	2.0	-	$V_{CC} + 0.5$	V
		V_{IL}	-0.5*	-	0.8	V
Ambient operating temperature	commercial	T_A	0	-	70	°C
	industrial	T_A	-40	-	85	°C

* $V_{IL, min} = -3.0V$ for pulse width less than $t_{RC}/2$.

DC operating characteristics (over the operating range)

Parameter	Symbol	Test conditions	-10		-12		-15		-20		Unit	
			Min	Max	Min	Max	Min	Max	Min	Max		
Input leakage current	$ I_{LI} $	$V_{CC} = \text{Max}$ $V_{IN} = \text{GND to } V_{CC}$	-	1	-	1	-	1	-	1	μA	
Output leakage current	$ I_{LO} $	$V_{CC} = \text{Max}$ $\overline{CE} = V_{IH}$ or $\overline{OE} = V_{IH}$ or $\overline{WE} = V_{IL}$ $V_{I/O} = \text{GND to } V_{CC}$	-	1	-	1	-	1	-	1	μA	
Operating power supply current	I_{CC}	$V_{CC} = \text{Max}$ Min cycle, 100% duty $\overline{CE} = V_{IL}$, $I_{OUT} = 0\text{mA}$	AS7C4098	-	-	-	250	-	220	-	180	mA
			AS7C34098	-	160	-	130	-	110	-	100	mA
Standby power supply current	I_{SB}	$V_{CC} = \text{Max}$ $\overline{CE} = V_{IH}$, $f = \text{Max}$	AS7C4098	-	-	-	60	-	60	-	60	mA
			AS7C34098	-	60	-	60	-	60	-	60	mA
	I_{SB1}	$V_{CC} = \text{Max}$ $\overline{CE} \geq V_{CC} - 0.2V$, $V_{IN} \geq V_{CC} - 0.2V$ or $V_{IN} \leq 0.2V$, $f = 0$	AS7C4098	-	-	-	20	-	20	-	20	mA
			AS7C34098	-	20	-	20	-	20	-	20	mA
Output voltage	V_{OL}	$I_{OL} = 8\text{ mA}$, $V_{CC} = \text{Min}$	-	0.4	-	0.4	-	0.4	-	0.4	V	
	V_{OH}	$I_{OH} = -4\text{ mA}$, $V_{CC} = \text{Min}$	2.4	-	2.4	-	2.4	-	2.4	-	V	

Shaded areas indicate preliminary information.

Capacitance ($f = 1\text{MHz}$, $T_a = 25^\circ\text{C}$, $V_{CC} = \text{NOMINAL}$)

Parameter	Symbol	Signals	Test conditions	Max	Unit
Input capacitance	C_{IN}	A, \overline{CE} , \overline{WE} , \overline{OE} , UB, LB	$V_{IN} = 0V$	6	pF
I/O capacitance	$C_{I/O}$	I/O	$V_{IN} = V_{OUT} = 0V$	8	pF



Read cycle (over the operating range)

Parameter	Symbol	-10		-12		-15		-20		Unit	Notes
		Min	Max	Min	Max	Min	Max	Min	Max		
Read cycle time	t_{RC}	10	-	12	-	15	-	20	-	ns	
Address access time	t_{AA}	-	10	-	12	-	15	-	20	ns	
Chip enable (\overline{CE}) access time	t_{ACE}	-	10	-	12	-	15	-	20	ns	
Output enable (\overline{OE}) access time	t_{OE}	-	5	-	6	-	7	-	9	ns	
Output hold from address change	t_{OH}	3	-	3	-	3	-	3	-	ns	5
\overline{CE} Low to output in low Z	t_{CLZ}	0	-	3	-	0	-	0	-	ns	4, 5
\overline{CE} High to output in high Z	t_{CHZ}	-	5	-	6	-	7	-	9	ns	4, 5
\overline{OE} Low to output in low Z	t_{OLZ}	0	-	0	-	0	-	0	-	ns	4, 5
\overline{OE} High to output in high Z	t_{OHZ}	-	5	-	6	-	7	-	9	ns	4, 5
\overline{LB} , \overline{UB} access time	t_{BA}	-	5	-	6	-	7	-	9	ns	
\overline{LB} , \overline{UB} Low to output in low Z	t_{BLZ}	0	-	0	-	0	-	0	-	ns	
\overline{LB} , \overline{UB} High to output in high Z	t_{BHZ}	-	5	-	6	-	7	-	9	ns	
Power up time	t_{PU}	0	-	0	-	0	-	0	-	ns	5
Power down time	t_{PD}	-	10	-	12	-	15	-	20	ns	5

Shaded areas indicate preliminary information.

Key to switching waveforms



Read waveform 1 (address controlled)

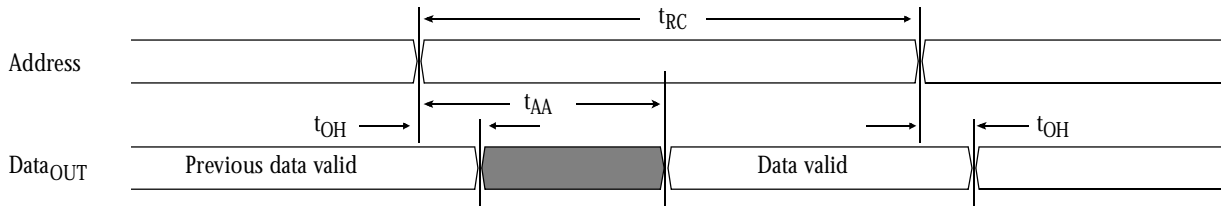

Read waveform 2 (\overline{CE} , \overline{OE} , \overline{UB} , \overline{LB} controlled)

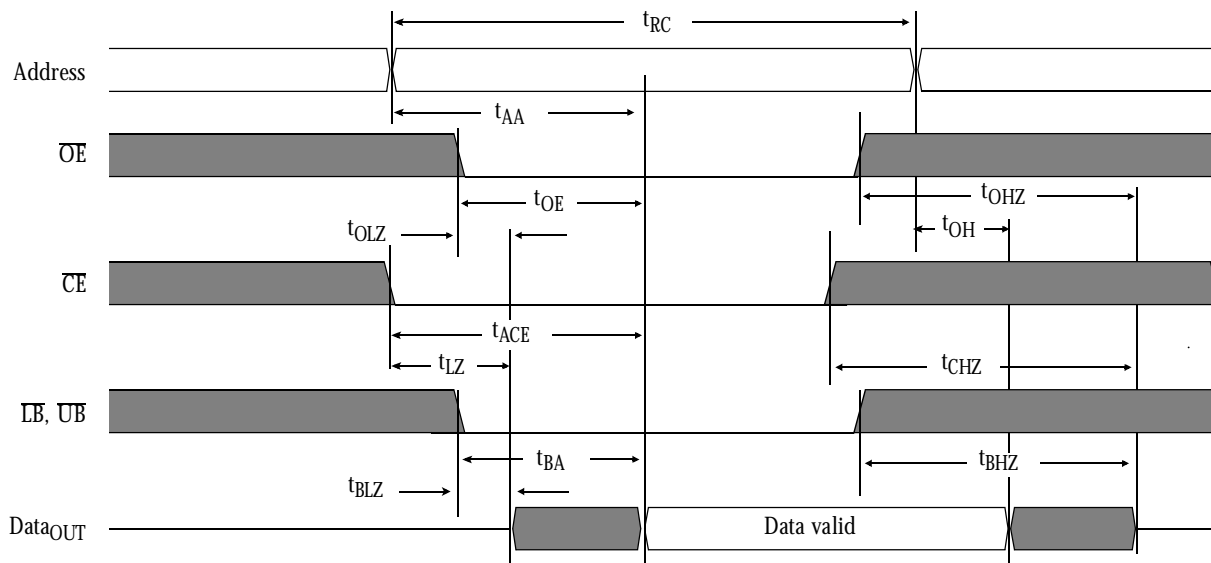



Write cycle (over the operating range)

Parameter	Symbol	-10		-12		-15		-20		Unit	Note
		Min	Max	Min	Max	Min	Max	Min	Max		
Write cycle time	t_{WC}	10	-	12	-	15	-	20	-	ns	
Chip enable (\overline{CE}) to write end	t_{CW}	7	-	8	-	10	-	12	-	ns	
Address setup to write end	t_{AW}	7	-	8	-	10	-	12	-	ns	
Address setup time	t_{AS}	0	-	0	-	0	-	0	-	ns	
Write pulse width ($\overline{OE} = \text{High}$)	t_{WP1}	7	-	8	-	10	-	12	-	ns	
Write pulse width ($\overline{OE} = \text{Low}$)	t_{WP2}	10	-	12	-	15	-	20	-	ns	
Address hold from end of write	t_{AH}	0	-	0	-	0	-	0	-	ns	
Data valid to write end	t_{DW}	5	-	6	-	7	-	9	-	ns	
Data hold time	t_{DH}	0	-	0	-	0	-	0	-	ns	4, 5
Write enable to output in High-Z	t_{WZ}	0	5	0	6	0	7	0	9	ns	4, 5
Output active from write end	t_{OW}	3	-	3	-	3	-	3	-	ns	4, 5
Byte enable Low to write end	t_{BW}	7	-	8	-	10	-	12	-	ns	4, 5

Shaded areas indicate preliminary information.

Write waveform 1 (\overline{WE} controlled)

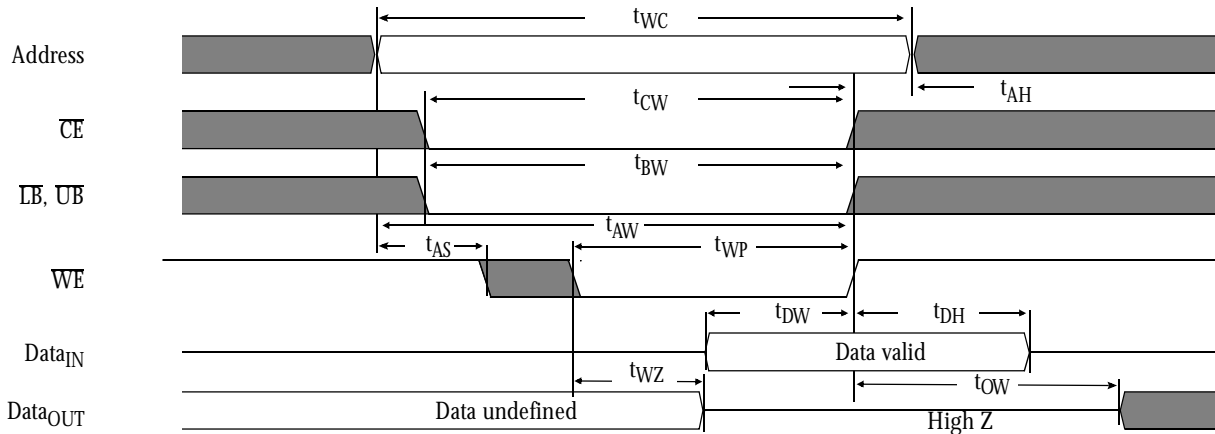

Write waveform 2 (\overline{CE} controlled)

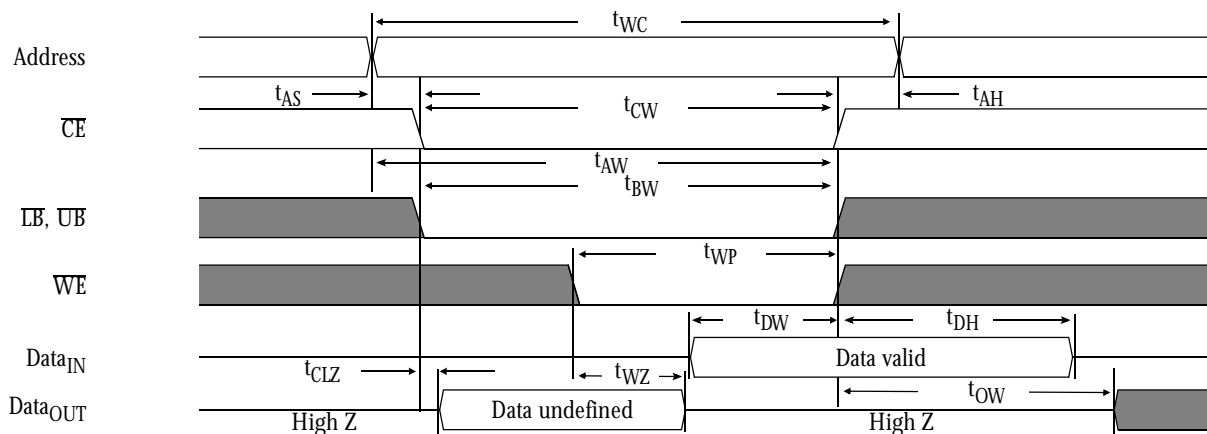



Write waveform 3

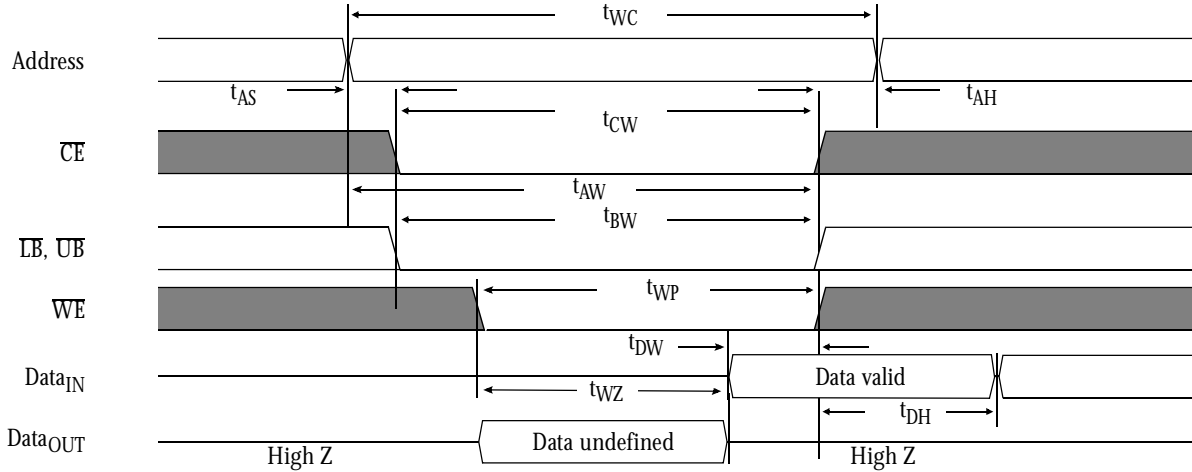

Data retention characteristics

Parameter	Symbol	Test conditions	Min	Max	Unit
V _{CC} for data retention	V _{DR}	V _{CC} = 2.0V	2.0	-	V
Data retention current	I _{CCDR}	CE ≥ V _{CC} - 0.2V	-	500	μA
Chip deselect to data retention time	t _{CDR}		0	-	ns
Operation recovery time	t _R	V _{IN} ≥ V _{CC} - 0.2V or V _{IN} ≤ 0.2V	t _{RC}	-	ns
Input leakage current	I _{LI}		-	1	μA

Data retention waveform

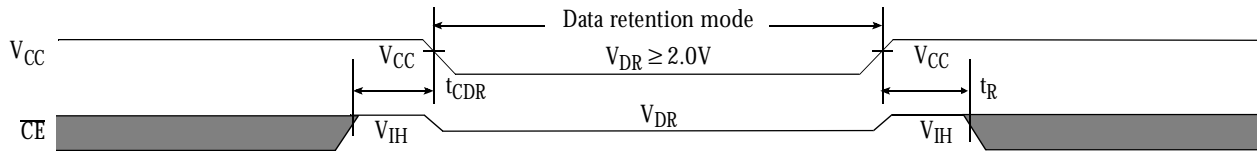

AC test conditions

- Output load: see Figure B or Figure C.
- Input pulse level: GND to 3.0V. See Figure A.
- Input rise and fall times: 2 ns. See Figure A.
- Input and output timing reference levels: 1.5V.

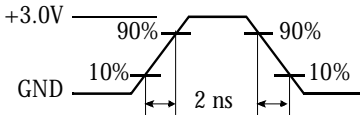

Figure A: Input pulse

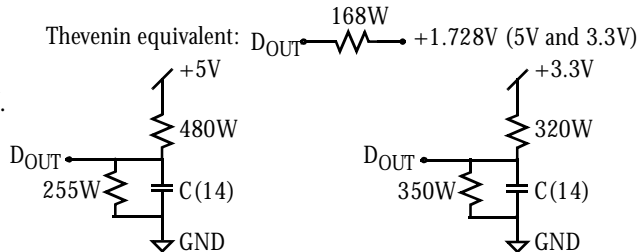

Figure B: 5V Output load

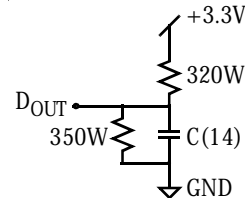

Figure C: 3.3V Output load

Notes

- 1 During V_{CC} power-up, a pull-up resistor to V_{CC} on CE is required to meet I_{SB} specification.
- 2 This parameter is sampled, but not 100% tested.
- 3 For test conditions, see AC Test Conditions, Figures A, B, C.
- 4 t_{CLZ} and t_{CHZ} are specified with C_L = 5pF as in Figure C. Transition is measured ±500mV from steady-state voltage.
- 5 This parameter is guaranteed, but not tested.
- 6 WE is High for read cycle.
- 7 CE and OE are Low for read cycle.
- 8 Address valid prior to or coincident with CE transition Low.
- 9 All read cycle timings are referenced from the last valid address to the first transitioning address.
- 10 CE or WE must be High during address transitions. Either CE or WE asserting high terminates a write cycle.
- 11 All write cycle timings are referenced from the last valid address to the first transitioning address.
- 12 Not applicable.
- 13 2V data retention applies to commercial temperature range operation only.
- 14 C = 30pF, except on High Z and Low Z parameters, where C = 5pF.



Typical DC and AC characteristics

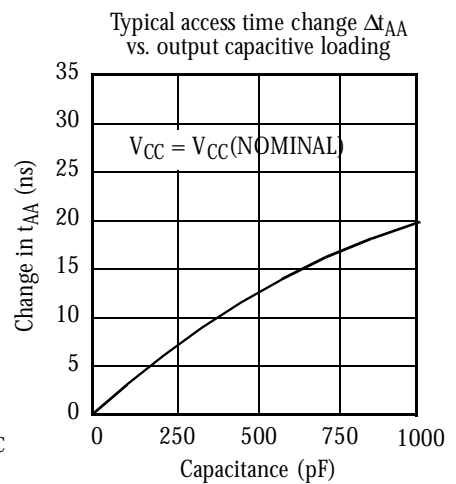
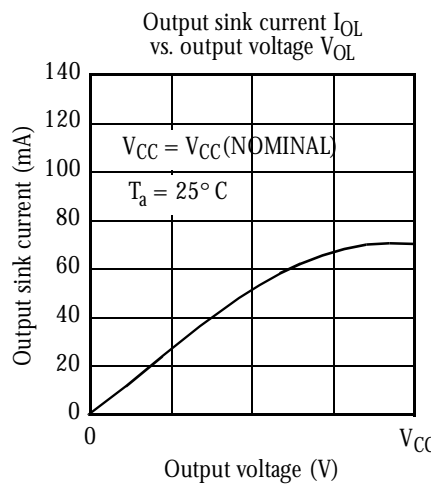
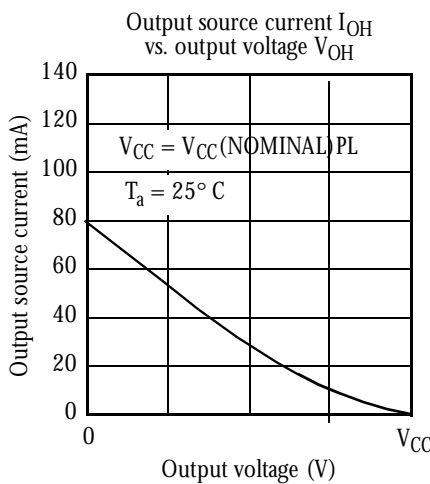
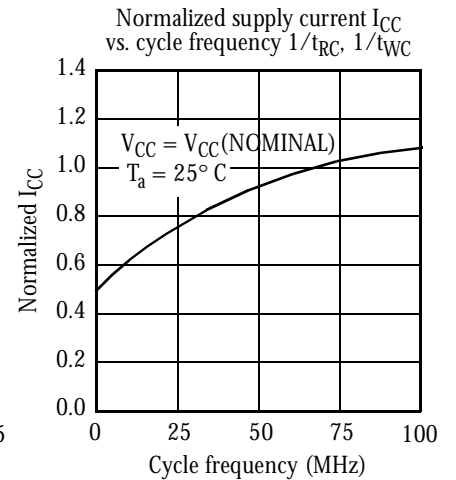
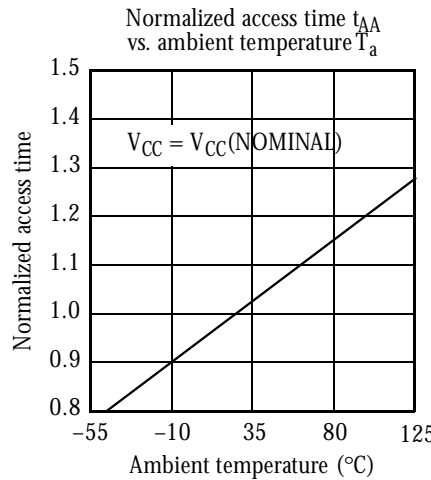
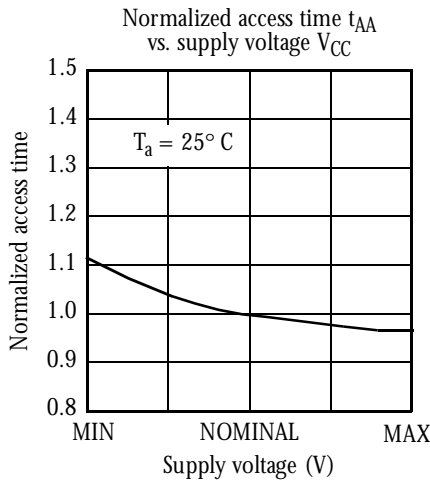
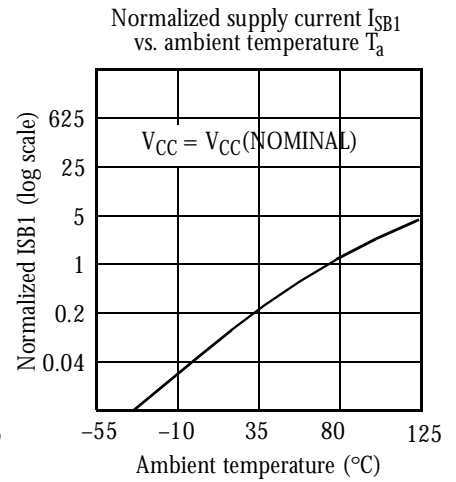
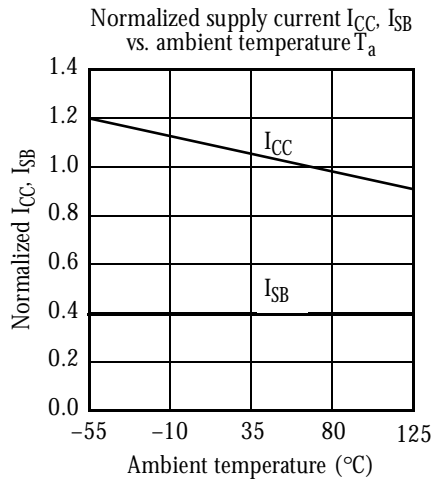
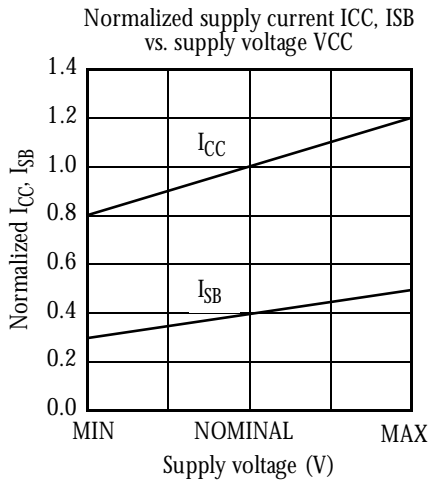

AS7C4098 AS7C34098



Package dimensions

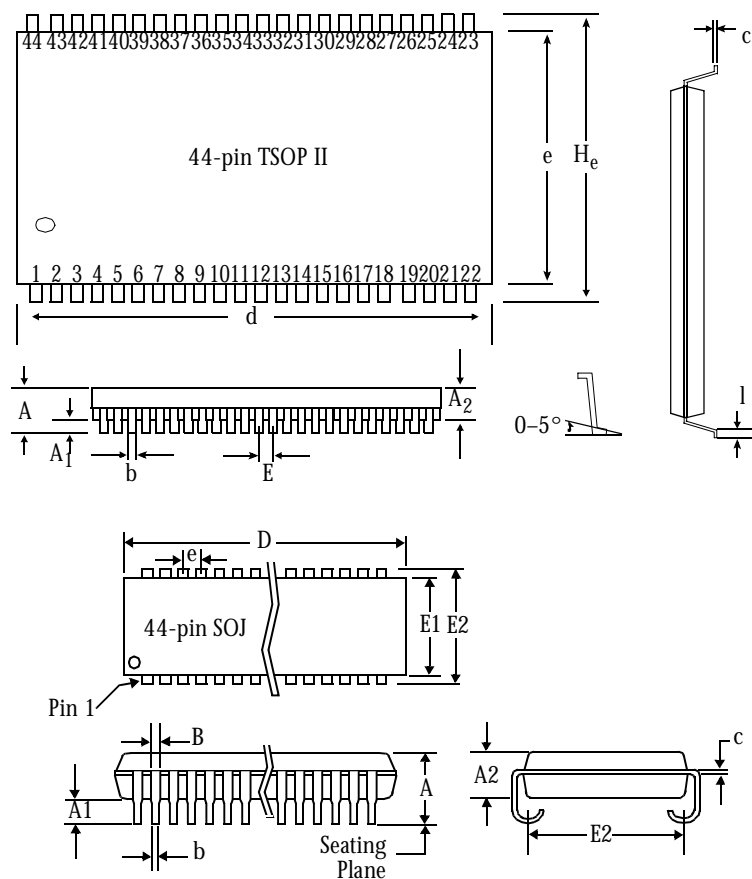

	44-pin TSOP II	
	Min (mm)	Max (mm)
A	1.2	
A ₁	0.05	
A ₂	0.95	1.05
b	0.25	0.45
c	0.15 (typical)	
d	20.85	21.05
e	10.06	10.26
H _e	11.56	11.96
E	0.80 (typical)	
l	0.40	0.60

	44-pin SOJ 400 mil	
	Min	Max
A	0.128	0.148
A ₁	0.025	-
A ₂	1.105	1.115
B	0.026	0.032
b	0.015	0.020
c	0.007	0.013
D	1.120	1.130
E	0.370 NOM	
E ₁	0.395	0.405
E ₂	0.435	0.445
e	0.050 NOM	

Ordering codes

Package	Version	10 ns	12 ns	15 ns	20 ns
SOJ	5V commercial	NA	AS7C4098-12JC	AS7C4098-15JC	AS7C4098-20JC
	5V industrial	NA	AS7C4098-12JI	AS7C4098-15JI	AS7C4098-20JI
	3.3V commercial	AS7C34098-10JC	AS7C34098-12JC	AS7C34098-15JC	AS7C34098-20JC
	3.3V industrial	NA	AS7C34098-12JI	AS7C34098-15JI	AS7C34098-20JI
TSOP II	5V commercial	NA	AS7C4098-12TC	AS7C4098-15TC	AS7C4098-20TC
	5V industrial	NA	AS7C4098-12TI	AS7C4098-15TI	AS7C4098-20TI
	3.3V commercial	AS7C34098-10TC	AS7C34098-12TC	AS7C34098-15TC	AS7C34098-20TC
	3.3V industrial	NA	AS7C34098-12TI	AS7C34098-15TI	AS7C34098-20TI

NA: not available.

Part numbering system

AS7C	X	4098	-XX	J, T	X
SRAM prefix	Blank: 5V CMOS 3: 3.3V CMOS	Device number	Access time	Packages: J: SOJ 400 mil T: TSOP II 400 mil	Temperature ranges: C: Commercial, 0°C to 70°C I: Industrial, -40°C to 85°C