

**4-BIT SINGLE-CHIP MICROCONTROLLER WITH PLL FREQUENCY
SYNTHESIZER CONTROLLER FOR PORTABLE FM/AM RADIO AND TV****DESCRIPTION**

The μ PD17071GB-012 is a CMOS microcontroller with an on-chip PLL frequency synthesizer for receiving international FM and AM and Japanese TV broadcasting.

In addition, because it includes a prescaler (230 MHz MAX.), IF counter, and LCD controller/driver, it constitutes a high-performance, multi-function FM, AM, or TV tuner on a single chip.

Housed in a 56-pin QFP and driven by two dry cells at a low voltage ($V_{DD} = 1.8$ to 3.6 V), the μ PD17071GB-012 is ideal for creating a compact portable clock radio and radio cassette recorder.

FEATURES

- Preset memory
Three bands: FM, AM, and Japanese TV (1 to 12 channels)
10 stations for each band, totaling 30 stations
- Last channel memory
One station for each band, totaling 3 stations
- Tuning function
 - Manual seek/auto seek
 - Auto store memory
 - Preset memory call
- LCD controller/driver
(1/4 duty, 1/2 bias, 3.1-V driven, frame frequency: 62.5 Hz)
- Watch function
12-hour or 24-hour indication
- Alarm function
Outputs alarm sound at set time every day
- Sleep timer function
Turns off radio after set time
(Time can be set in a range of 30 to 120 minutes in units of 30 minutes.)
- Low-voltage operation
 $V_{DD} = 1.8$ to 3.6 V

ORDERING INFORMATION

Part Number	Package
μ PD17071GB-012-1A7	56-pin plastic QFP (10 × 10 mm, 0.65 mm pitch)

The information in this document is subject to change without notice.

FUNCTIONAL OUTLINE

Receive frequency, channel space, reference frequency, intermediate frequency, station detection mode

(1/2)

Region	Band	Receive Frequency	Channel Space	Reference Frequency	Intermediate Frequency	Station Detection Mode	
Japan	FM	76.0 to 90.0 MHz	100 kHz	25 kHz	-10.71 MHz	IF only IF and SD	
		76.0 to 108.0 MHz	100 kHz	25 kHz	-10.71 MHz	IF only IF and SD	
	AM	522 to 1629 kHz	9 kHz	3 kHz	450 kHz	IF only IF and SD	
					459 kHz	IF only IF and SD	
					10.71 MHz	IF only IF and SD	
	TV	1 to 12 ch	—	25 kHz	-10.71 MHz	IF only IF and SD	
	U.S.A.	FM	87.5 to 107.9 MHz	200 kHz	25 kHz	10.71 MHz	IF only IF and SD
				100 kHz	25 kHz	10.71 MHz	IF only IF and SD
		AM	530 to 1710 kHz	10 kHz	5 kHz	450 kHz	IF only IF and SD
						460 kHz	IF only IF and SD
10.71 MHz						IF only IF and SD	
China		FM	87.0 to 108.0 MHz	100 kHz	25 kHz	10.71 MHz	IF only IF and SD
	50 kHz			25 kHz	10.71 MHz	IF only IF and SD	
	AM	522 to 1611 kHz	9 kHz	3 kHz	450 kHz	IF only IF and SD	
					10.71 MHz	IF only IF and SD	
Europe 1	FM	87.5 to 108.0 MHz	50 kHz	25 kHz	10.71 MHz	IF only IF and SD	
					10.71 MHz	IF only IF and SD	
	AM	530 to 1620 kHz	10 kHz	5 kHz	450 kHz	IF only	
					459 kHz	IF only	
					10.71 MHz	IF only	
		522 to 1629 kHz	9 kHz	3 kHz	450 kHz	IF only IF and SD	
					459 kHz	IF only IF and SD	
10.71 MHz	IF only IF and SD						
Europe 2	FM	87.5 to 108.0 MHz	50 kHz	25 kHz	10.71 MHz	IF only IF and SD	
					10.71 MHz	IF only IF and SD	
	AM	530 to 1620 kHz	10 kHz	5 kHz	450 kHz	IF only	
					459 kHz	IF only	
					10.71 MHz	IF only	
		522 to 1629 kHz	9 kHz	3 kHz	450 kHz	IF only IF and SD	
					459 kHz	IF only IF and SD	
10.71 MHz	IF only IF and SD						

Remark The initial values in the preset memory differ between “Europe 1” and “Europe 2”.

Setting of Pin Input				Setting of Initialization Diode Switch			
9k/10k SD	AREA0	AREA1	Japan Wide 100k/200k	CHINA BAND	IFSEL0	IFSEL1	SD_IF
Don't care	L	L	L	0	Don't care	Don't care	0
Don't care	L	L	L	0	Don't care	Don't care	1
Don't care	L	L	H	0	Don't care	Don't care	0
Don't care	L	L	H	0	Don't care	Don't care	1
Don't care	L	L	Don't care	0	0	0	0
Don't care	L	L	Don't care	0	0	0	1
Don't care	L	L	Don't care	0	1	0	0
Don't care	L	L	Don't care	0	1	0	1
Don't care	L	L	Don't care	0	0	1	0
Don't care	L	L	Don't care	0	0	1	1
Don't care	L	L	Don't care	0	Don't care	Don't care	0
Don't care	L	L	Don't care	0	Don't care	Don't care	1
Don't care	L	H	L	0	Don't care	Don't care	0
Don't care	L	H	L	0	Don't care	Don't care	1
Don't care	L	H	H	0	Don't care	Don't care	0
Don't care	L	H	H	0	Don't care	Don't care	1
Don't care	L	H	Don't care	0	0	0	0
Don't care	L	H	Don't care	0	0	0	1
Don't care	L	H	Don't care	0	1	0	0
Don't care	L	H	Don't care	0	1	0	1
Don't care	L	H	Don't care	0	0	1	0
Don't care	L	H	Don't care	0	0	1	1
Don't care	Don't care	Don't care	L	1	Don't care	Don't care	0
Don't care	Don't care	Don't care	L	1	Don't care	Don't care	1
Don't care	Don't care	Don't care	H	1	Don't care	Don't care	0
Don't care	Don't care	Don't care	H	1	Don't care	Don't care	1
Don't care	Don't care	Don't care	Don't care	1	0	0	0
Don't care	Don't care	Don't care	Don't care	1	0	0	1
Don't care	Don't care	Don't care	Don't care	1	0	1	0
Don't care	Don't care	Don't care	Don't care	1	0	1	1
Don't care	H	L	Don't care	0	Don't care	Don't care	0
Don't care	H	L	Don't care	0	Don't care	Don't care	1
L	H	L	Don't care	0	0	0	0
L	H	L	Don't care	0	1	0	0
L	H	L	Don't care	0	0	1	0
H	H	L	Don't care	0	0	0	0
Don't care	H	L	Don't care	0	0	0	1
H	H	L	Don't care	0	1	0	0
Don't care	H	L	Don't care	0	1	0	1
H	H	L	Don't care	0	0	1	0
Don't care	H	L	Don't care	0	0	1	1
Don't care	H	H	Don't care	0	Don't care	Don't care	0
Don't care	H	H	Don't care	0	Don't care	Don't care	1
L	H	H	Don't care	0	0	0	0
L	H	H	Don't care	0	1	0	0
L	H	H	Don't care	0	0	1	0
H	H	H	Don't care	0	0	0	0
Don't care	H	H	Don't care	0	0	0	1
H	H	H	Don't care	0	1	0	0
Don't care	H	H	Don't care	0	1	0	1
H	H	H	Don't care	0	0	1	0
Don't care	H	H	Don't care	0	0	1	1

Remarks 1. H: High-level input, L: Low-level input
 2. 0: Open, 1: Short

INITIAL VALUE OF PRESET MEMORY

The contents of the preset memory on first power application differ depending on the destination region, as follows:

Destination	Band	Preset Memory										
		Last	M1	M2	M3	M4	M5	M6	M7	M8	M9	M10
Japan	FM (MHz)	77.5	77.5	80.0	82.5	85.0	87.5	76.0	90.0	76.0	76.0	76.0
	FM wide (MHz)	76.0	76.0	90.0	98.0	106.0	108.0	76.0	90.0	76.0	76.0	76.0
	AM (kHz)	603	603	810	999	1440	1620	522	522	522	522	522
	TV (ch)	1 ch	1 ch	3 ch	4 ch	8 ch	12 ch	1 ch	1 ch	1 ch	1 ch	1 ch
U.S.A.	FM100 k (MHz)	87.5	87.5	90.0	98.0	106.0	108.0	87.5	87.5	87.5	87.5	87.5
	FM200 k (MHz)	87.5	87.5	90.1	98.1	106.1	107.9	87.5	87.5	87.5	87.5	87.5
	AM (kHz)	530	530	600	1000	1200	1440	1710	530	530	530	530
China	FM (MHz)	87.0	87.0	87.0	87.0	87.0	87.0	87.0	87.0	87.0	87.0	87.0
	AM (kHz)	522	522	522	522	522	522	522	522	522	522	522
Europe 1	FM (MHz)	87.5	87.5	90.0	98.0	106.0	108.0	87.5	87.5	87.5	87.5	87.5
	AM9 k (kHz)	522	522	603	999	1440	1602	522	522	522	522	522
	AM10 k (kHz)	530	530	600	1000	1400	1610	530	530	530	530	530
Europe 2	FM (MHz)	87.5	87.5	90.1	98.1	106.1	108.0	87.5	87.5	87.5	87.5	87.5
	AM9 k (kHz)	522	522	603	999	1440	1602	522	522	522	522	522
	AM10 k (kHz)	530	530	600	1000	1400	1610	530	530	530	530	530

Remark The initial values in the preset memory differ between “Europe 1” and “Europe 2”.

Tuning Function

(1) Manual tuning

Type	Description
Manual up Manual down	Increments or decrements frequency one step each time the corresponding key is pressed.

(2) Auto tuning

Type	Description
Seek up Seek down	Searches station in up or down direction and, when station has been found, holds frequency of station.

(3) Preset memory

Stores 10 stations for each band (FM, AM, and TV) by using 10 buttons, totaling 30 stations.

(4) Preset memory call

Receives the frequency written to the preset memory.

(5) Auto store memory

Searches all the frequencies in the received band, and automatically writes the frequencies of stations to the preset memory.

(6) Last channel memory

Stores the frequency of the station received last in each of the three bands (FM, AM, and TV), totaling three stations.

WATCH FUNCTION

- (1) 12-hour (with “AM” and “PM” indication) or 24-hour indication
The time indication mode is automatically selected according to the selected destination region.
- (2) Time on power application
On power application, the time is set to “00:00” (midnight) and counting is started.

TIMER FUNCTION

- (1) Alarm function
Outputs an alarm sound at set time every day.
- (2) Sleep timer
Automatically turns off radio after 30 to 120 minutes (the time can be set in units of 30 minutes).

OTHERS

- (1) Outputs beep sound to confirm valid momentary key input.
- (2) Watch/frequency (mode) indication selection
- (3) Mute control output
- (4) Key lock function

PIN CONFIGURATION (Top View)

56-pin plastic QFP (10 × 10 mm, 0.65-mm pitch)

μPD17071GB-012-1A7

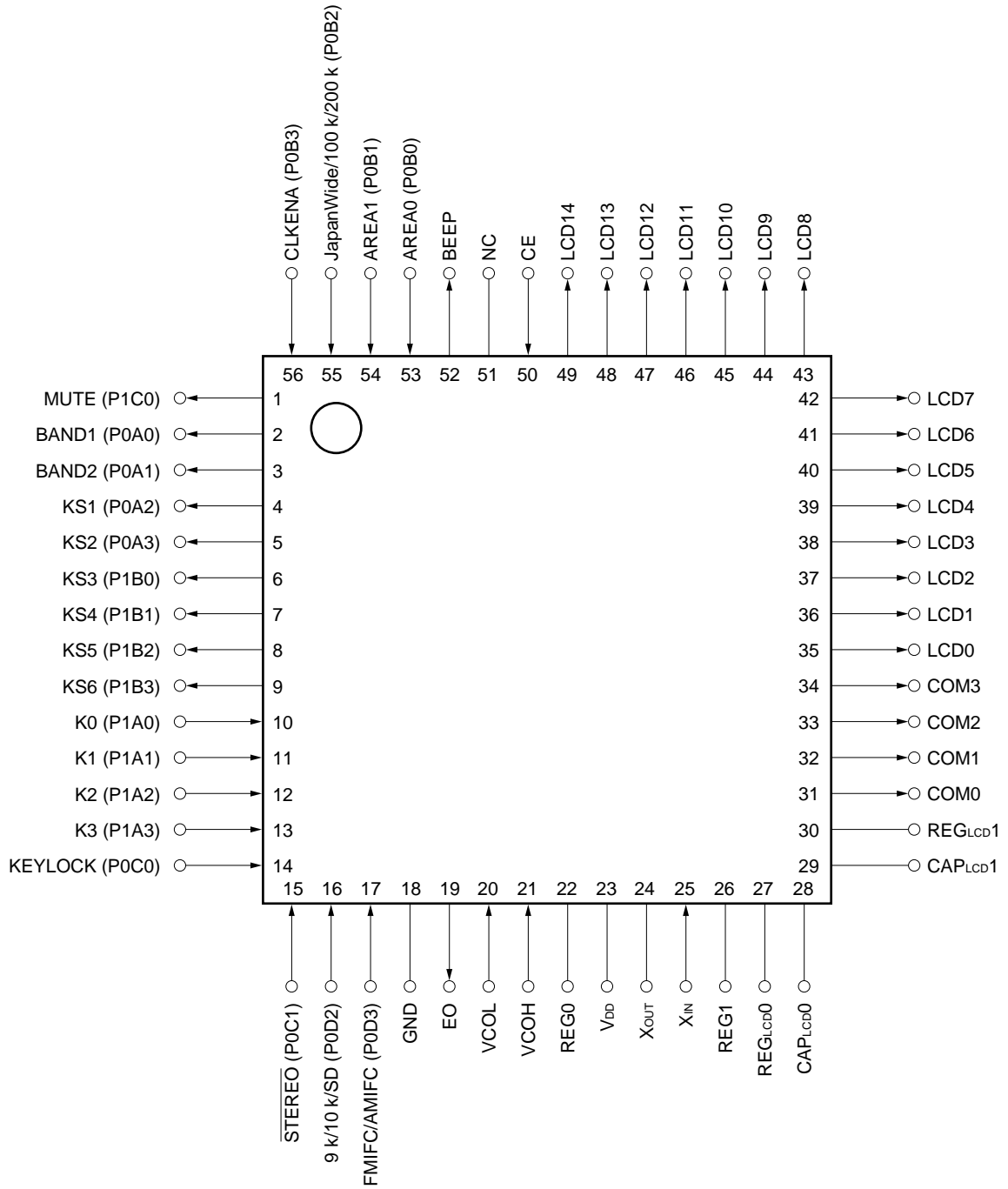

Remark (): Pins for μPD17071GB-XXX-1A7

TABLE OF CONTENTS

1. PIN FUNCTION9

2. CONFIGURATION OF KEY MATRIX15

2.1 Layout of Initialization Diode Key Matrix15

2.2 Layout of Momentary Key Matrix15

2.3 Connection of Key Matrix16

2.4 Description of Key Matrix17

 2.4.1 Initialization diode matrix17

 2.4.2 Momentary key20

2.5 Alarm Function28

2.6 Key Lock Function29

3. LCD DISPLAY30

3.1 LCD Panel30

3.2 Font30

3.3 LCD Pattern30

3.4 LCD Pin Assignment31

3.5 Display Description33

3.6 Display Example34

4. MUTE OUTPUT TIMING CHART36

4.1 Manual up/down (operates by pressing key and releasing within 0.5 sec)36

4.2 Auto up/down (operates by holding down key for 0.5 sec or longer)36

4.3 Calling Preset Memory37

4.4 Band Selection37

4.5 CE Pin37

 4.5.1 High level to low level37

 4.5.2 Low level to high level37

4.6 Sleep Timer38

5. ELECTRICAL SPECIFICATIONS (PRELIMINARY)39

6. PACKAGE42

1. PIN FUNCTION

Pin No.	Symbol	Pin Name	Description	I/O Form															
1	MUTE	Mute output	<p>Outputs a mute control signal.</p> <p>Outputs a high level in the following cases:</p> <ul style="list-style-type: none"> • When radio is turned ON/OFF • When the frequency band is changed • During manual tuning • During auto tuning • When the preset memory is called • In power-off state 	CMOS push-pull output															
2 3	BAND1 BAND2	Band select signal output	<p>These pins output band select signals.</p> <p>The output of each band is as follows:</p> <table border="1" style="margin-left: auto; margin-right: auto;"> <thead> <tr> <th style="text-align: center;">Pin Selected band</th> <th style="text-align: center;">BAND1</th> <th style="text-align: center;">BAND2</th> </tr> </thead> <tbody> <tr> <td style="text-align: center;">AM</td> <td style="text-align: center;">0</td> <td style="text-align: center;">0</td> </tr> <tr> <td style="text-align: center;">FM</td> <td style="text-align: center;">1</td> <td style="text-align: center;">0</td> </tr> <tr> <td style="text-align: center;">TV (1 to 3 ch)</td> <td style="text-align: center;">1</td> <td style="text-align: center;">1</td> </tr> <tr> <td style="text-align: center;">TV (4 to 12 ch)</td> <td style="text-align: center;">1</td> <td style="text-align: center;">1</td> </tr> </tbody> </table> <p>(0: Low level, 1: High level)</p>	Pin Selected band	BAND1	BAND2	AM	0	0	FM	1	0	TV (1 to 3 ch)	1	1	TV (4 to 12 ch)	1	1	CMOS push-pull output
Pin Selected band	BAND1	BAND2																	
AM	0	0																	
FM	1	0																	
TV (1 to 3 ch)	1	1																	
TV (4 to 12 ch)	1	1																	
4 9	KS1 KS6	Key source output	Key source output pins of a key matrix	CMOS push-pull output															
10 13	K0 K3	Key return signal input	These pins input the key return signals of a key matrix. They are connected to an internal pull-down resistor.	Input															
14	KEYLOCK	Key lock signal input	<p>This pin inputs a key lock signal.</p> <p>The signal input to this pin is used to lock or unlock a momentary key.</p> <p>Input a signal to this pin as follows:</p> <ul style="list-style-type: none"> • High level: To lock the momentary key. <p>All momentary keys are invalid while the keys are locked.</p> <ul style="list-style-type: none"> • Low level: To unlock the keys. <p>Note, however, that a high level or low level of less than 32 ms is invalid.</p>	Input															
15	STEREO	Stereo signal input	<p>This pin inputs a stereo signal.</p> <p>Reception of stereo broadcasting is identified by the signal input to this pin.</p> <p>Input a low level to this pin while stereo broadcasting is being received.</p>	Input															

Pin No.	Symbol	Pin Name	Description	I/O Form																								
16	9 k/10 k /SD	AM setting input/ SD signal input	<p>This pin inputs an SD (Station Detector) signal. When “Europe 1” or “Europe 2” is selected as the destination region, this pin can be also used to input setting of a channel space in an AM band.</p> <p>(1) Setting of channel space in AM band for “Europe 1” and “Europe 2” (9 k/10k) This setting is valid only when “Europe 1” or “Europe 2” is selected as the destination region. The setting is read only on power application (power-ON reset), or when the signal input to the CE pin (pin 50) goes high (CE reset); otherwise, it is ignored. Input a signal to this pin as follows:</p> <ul style="list-style-type: none"> • High level: Channel space 9 kHz • Low level: Channel space 10 kHz <p>Note that the setting of this pin is invalid when initialization diode switch SD_IF = 1, and the channel space is 9 kHz.</p> <p>(2) Input of SD signal (SD) When a station has been detected this is identified by the signal input to this pin and the frequency counter when initialization diode switch SD_IF = 1. Input a high level to this pin when a station is detected. However, a signal input for less than 32 ms is invalid.</p>	Input																								
17	FMIFC /AMIFC	FM/AM intermediate frequency input	<p>This pin inputs an intermediate frequency (IF) in an FM or AM band. The signal input to this pin is used to identify a station. When initialization diode switch SD_IF = 1, however, the signal input to this pin and the signal input to the SD pin (pin 16) are used to identify a station. The range of the input frequency in which detection of a station is identified is as follows:</p> <table border="1"> <thead> <tr> <th>Band</th> <th>Input frequency range <1></th> <th>Input frequency range <2></th> </tr> </thead> <tbody> <tr> <td>FM</td> <td colspan="2">10.7 MHz ± 20 kHz</td> </tr> <tr> <td>AM</td> <td>450 kHz ± 1 kHz</td> <td>459/460 kHz ± 1 kHz</td> </tr> <tr> <td>TV</td> <td colspan="2">10.7 MHz ± 20 kHz</td> </tr> </tbody> </table> <p>The conditions of input frequency ranges <1> and <2> vary as follows depending on the setting of initialization diodes IFSEL1 and IFSEL2.</p> <table border="1"> <thead> <tr> <th>IFSEL1</th> <th>IFSEL2</th> <th>Selected frequency range</th> </tr> </thead> <tbody> <tr> <td>0</td> <td>0</td> <td>Input frequency range <1></td> </tr> <tr> <td>1</td> <td>0</td> <td>Input frequency range <2></td> </tr> <tr> <td>0</td> <td>1</td> <td>Input frequency range <1></td> </tr> </tbody> </table> <p>(0: Open, 1: Short)</p>	Band	Input frequency range <1>	Input frequency range <2>	FM	10.7 MHz ± 20 kHz		AM	450 kHz ± 1 kHz	459/460 kHz ± 1 kHz	TV	10.7 MHz ± 20 kHz		IFSEL1	IFSEL2	Selected frequency range	0	0	Input frequency range <1>	1	0	Input frequency range <2>	0	1	Input frequency range <1>	Input
Band	Input frequency range <1>	Input frequency range <2>																										
FM	10.7 MHz ± 20 kHz																											
AM	450 kHz ± 1 kHz	459/460 kHz ± 1 kHz																										
TV	10.7 MHz ± 20 kHz																											
IFSEL1	IFSEL2	Selected frequency range																										
0	0	Input frequency range <1>																										
1	0	Input frequency range <2>																										
0	1	Input frequency range <1>																										
18	GND	Ground	Ground pin																									

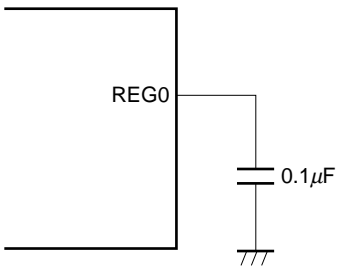
Pin No.	Symbol	Pin Name	Description	I/O Form									
19	EO	Error out	<p>This pin outputs PLL (Phase Locked Loop) errors. It outputs the result of comparison between the frequency input to the VCOH (pin 21) or VCOL (pin 20) and a set frequency.</p> <ul style="list-style-type: none"> • Input frequency > Set frequency: High level • Input frequency < Set frequency: Low level • Input frequency = Set frequency: Floating <p>Connect this pin to a varactor diode via an external LPF (lowpass filter).</p>	CMOS 3-state output									
20	VCOL	AM local oscillation input	<p>This pin inputs local oscillation output (VCO output) in an AM band. The signal that can be input to this pin is as follows:</p> <table border="1"> <thead> <tr> <th>Selected intermediate frequency</th> <th>Frequency range (MHz)</th> <th>Minimum amplitude (Vp-p)</th> </tr> </thead> <tbody> <tr> <td>10.71 MHz</td> <td>5 to 50</td> <td>0.2</td> </tr> <tr> <td>Other than 10.71 MHz</td> <td>0.3 to 8</td> <td>0.2</td> </tr> </tbody> </table> <p>Because an internal AC amplifier is provided, cut the DC component of the input signal with a capacitor.</p>	Selected intermediate frequency	Frequency range (MHz)	Minimum amplitude (Vp-p)	10.71 MHz	5 to 50	0.2	Other than 10.71 MHz	0.3 to 8	0.2	Input
Selected intermediate frequency	Frequency range (MHz)	Minimum amplitude (Vp-p)											
10.71 MHz	5 to 50	0.2											
Other than 10.71 MHz	0.3 to 8	0.2											
21	VCOH	FM local oscillation input	<p>This pin inputs local oscillation output (VCO output) in an FM and TV band. The signal that can be input to this pin is as follows:</p> <table border="1"> <thead> <tr> <th>Frequency range (MHz)</th> <th>Minimum amplitude (V_{p-p})</th> </tr> </thead> <tbody> <tr> <td>4 to 230</td> <td>0.2</td> </tr> </tbody> </table> <p>Because an internal AC amplifier is provided, cut the DC component of the input signal with a capacitor.</p>	Frequency range (MHz)	Minimum amplitude (V _{p-p})	4 to 230	0.2	Input					
Frequency range (MHz)	Minimum amplitude (V _{p-p})												
4 to 230	0.2												
22	REG0	Power supply pin	<p>This is a voltage regulator pin for PLL. Connect this pin to GND via a 0.1-μF capacitor. It outputs a low level when the radio is off.</p> 	—									
23	V _{DD}	Power supply pin	<p>This is a power supply pin. It supplies a voltage of V_{DD} = 1.8 to 3.6 V (T_A = -20 to +70 °C) to operate all the functions. Do not apply a voltage higher than that applied to the V_{DD} pin to any pin other than the V_{DD} pin.</p>	—									
24	X _{OUT}	Crystal resonator	<p>These pins are used to connect a crystal resonator for system clock oscillation. Connect a 75-kHz crystal resonator across these pins.</p>	CMOS push-pull									
25	X _{IN}		<p>The accuracy of the watch is affected only by the oscillation frequency of the crystal resonator.</p>	—									

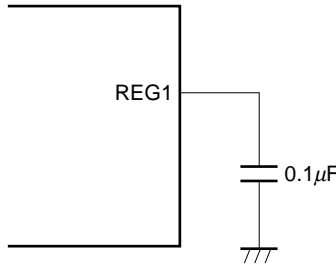
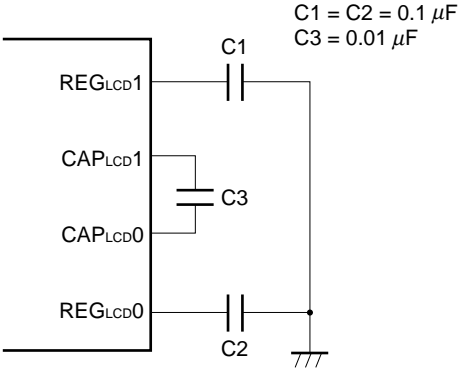
Pin No.	Symbol	Pin Name	Description	I/O Form
26	REG1	Power supply pin	<p>This pin is a voltage regulator pin for oscillation circuit. Connect this pin to GND via a 0.1-μF capacitor.</p> 	—
27 28 29 30	REG _{Lcd0} CAP _{Lcd0} CAP _{Lcd1} REG _{Lcd1}	LCD driving power supply pins	<ul style="list-style-type: none"> • REG_{Lcd1} and REG_{Lcd0} • These pins supply the LCD driving voltage. • CAP_{Lcd1} and CAP_{Lcd0} • Connect a capacitor for a doubler circuit across these pins to create an LCD driving voltage. • Connect the capacitor as shown below to create the doubler circuit.  <p>Caution The value of the LCD drive voltage changes if the values of C1, C2, and C3 are changed because of the configuration of the doubler circuit.</p>	—
31 34	COM0 COM3	LCD common signal output	<p>These pins output common signals to an LCD panel. They output 60 dots on the LCD panel by creating a matrix with LCD0 through LCD14 pins (pins 35 through 49).</p>	CMOS push-pull output
35 49	LCD0 LCD14	LCD segment signal output	<p>These pins outputs segment signals to an LCD panel. They display 60 dots on the LCD panel by creating a matrix with COM0 through COM3 pins (pins 31 through 34).</p>	CMOS push-pull output
50	CE	Chip enable	<p>This input pins selects radio operation as follows:</p> <ul style="list-style-type: none"> • High level Turns ON the radio. • Low level Turns OFF the radio. <p>Note, however, that a high or low level of less than 200 μs is not accepted.</p>	Input
51	NC	No connection	No connection. Externally pull down this pin.	—

Pin No.	Symbol	Pin Name	Description	I/O Form															
52	BEEP	BEEP/ALARM output	<p>This pin outputs a key-ON confirmation sound (beep output) and alarm sound.</p> <p>(1) Beep output A pulse of 1.5 kHz is output for about 40 ms in the following cases:</p> <ul style="list-style-type: none"> • When a valid key is input • While time is adjusted up or down in high-speed mode • During seek up/down <p>(2) Alarm sound output When the time reaches the alarm time set, a 3 kHz pulse is intermittently output approximately every 64 ms, five times after 1 second. The alarm sound is output for 10 minutes from the start of output, or until it is canceled.</p>	CMOS push-pull output															
53 54	AREA0 AREA1	Destination region setting input	<p>These pins input setting for the destination region. The setting of these pins is read only on application of V_{DD} (power-ON reset) or when the signal input to the CE pin goes high (CE reset); otherwise, it is ignored. Input a signal to these pins as follows:</p> <table border="1" style="margin-left: auto; margin-right: auto;"> <thead> <tr> <th>AREA0</th> <th>AREA1</th> <th>Destination region</th> </tr> </thead> <tbody> <tr> <td>0</td> <td>0</td> <td>Japan</td> </tr> <tr> <td>0</td> <td>1</td> <td>U.S.A.</td> </tr> <tr> <td>1</td> <td>0</td> <td>Europe 1</td> </tr> <tr> <td>1</td> <td>1</td> <td>Europe 2</td> </tr> </tbody> </table> <p>(0: Low level, 1: High level) When initialization diode switch CHINA_BAND = 1, however, the setting is invalid, and the destination region is China.</p>	AREA0	AREA1	Destination region	0	0	Japan	0	1	U.S.A.	1	0	Europe 1	1	1	Europe 2	Input
AREA0	AREA1	Destination region																	
0	0	Japan																	
0	1	U.S.A.																	
1	0	Europe 1																	
1	1	Europe 2																	

Pin No.	Symbol	Pin Name	Description	I/O Form
55	Japan Wide/ 100 k/200 k	FM setting input	<p>This pin inputs an FM receive frequency band and setting of a channel space. The setting differs depending on the destination region. The setting is read only on application of V_{DD} (power-ON reset) or when the CE pin (pin 50) goes high (CE reset); otherwise, it is ignored.</p> <p>(1) When the destination region is Japan (Japan Wide) Sets an FM receive frequency band. Input as follows:</p> <ul style="list-style-type: none"> • High-level input: 76.0 to 108.0 MHz • Low-level input: 76.0 to 90.0 MHz <p>(2) When the destination region is the U.S.A. (100 k/200 k) Sets the channel space of the FM band. Input as follows:</p> <ul style="list-style-type: none"> • High-level input: 100-kHz step • Low-level input: 200-kHz step <p>(3) When the destination region is China (100 k/200 k) Sets the channel space of the FM band. Input as follows:</p> <ul style="list-style-type: none"> • High-level input: 50-kHz step • Low-level input: 100-kHz step 	Input
56	CLKENA	Watch function selection input	<p>This pin inputs the setting for whether the watch function is used or not. The setting is read only on application of V_{DD} (power-ON reset) or when the CE pin (pin 50) goes high (CE reset); otherwise, it is ignored. Input as follows:</p> <ul style="list-style-type: none"> • High-level input: Watch function used. • Low-level input: Watch function not used. 	Input

2. CONFIGURATION OF KEY MATRIX

2.1 Layout of Initialization Diode Key Matrix

Input Pin (Pin No.) Output Pin (Pin No.)	K0 (10)	K1 (11)	K2 (12)	K3 (13)
KS1 (4)	—	CHINA_BAND	TV_ENA	STOPSEL
KS2 (5)	SD_IF	MEMSEL	IFSEL1	IFSEL2



Remark —: Not set

2.2 Layout of Momentary Key Matrix

Input Pin (Pin No.) Output Pin (Pin No.)	K0 (10)	K1 (11)	K2 (12)	K3 (13)
KS3 (6)	SLEEP	CHECK	STOP	BAND
KS4 (7)	AUTO STORE	M4	M5	+5
KS5 (8)	MEMORY/AUTO STORE	M1/MEMORY UP	M2	M3
KS6 (9)	MODE	UP	DOWN	ALARM

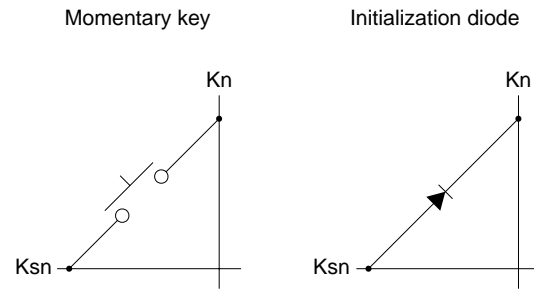
2.3 Connection of Key Matrix



-  Momentary key
-  Initialization diode

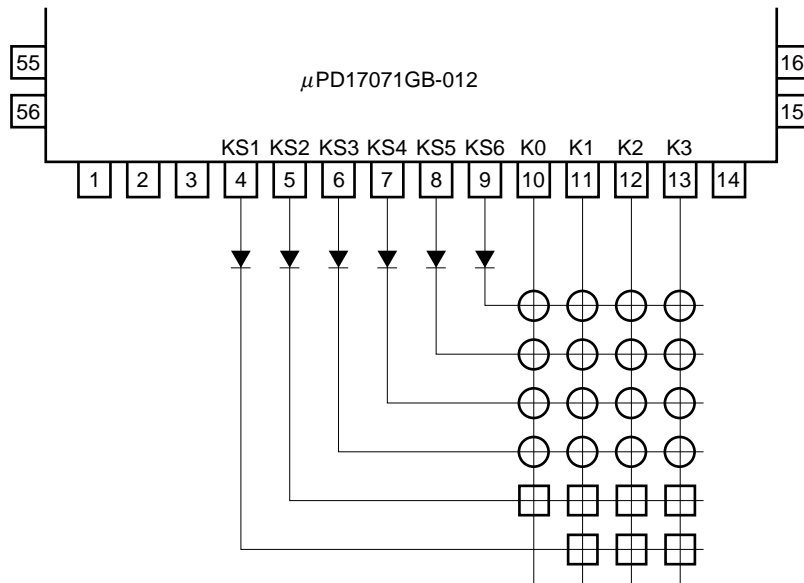

2.4 Description of Key Matrix

2.4.1 Initialization diode matrix

The initialization diode matrix determines the function of the μ PD17071GB-012. Be sure to set this diode matrix.

The setting of the diode matrix is read only on application of V_{DD} (power-ON reset), or when the CE pin (pin 50) goes high (CE reset); otherwise, it is ignored.

- (1) Switch setting destination region
CHINA_BAND
- (2) Switch setting receivable band (valid only when the destination region is Japan)
TV_ENA
- (3) Switches setting intermediate frequency of AM band
IFSEL1, IFSEL2
- (4) Switch setting station detection identification method
SD_IF
- (5) Switch setting momentary key for preset memory manipulation
MEMSEL
- (6) Switch setting momentary key for alarm sound canceling operation
STOPSEL

To set these switches, short-circuit (1) or open (0) the corresponding switches on the matrix with a diode. The function of the initialization diode matrix is explained next (in alphabetical order).

Initialization Diode	Function Description															
CHINA_BAND	<p>This switch selects the destination region of the application set. Set this switch as follows:</p> <table border="1" data-bbox="407 268 1360 401"> <thead> <tr> <th>CHINA_BAND</th> <th>Destination region</th> </tr> </thead> <tbody> <tr> <td>0</td> <td>Set by AREA0 and AREA1 pins</td> </tr> <tr> <td>1</td> <td>China</td> </tr> </tbody> </table> <p>(0: Open, 1: Short) If China is selected as the region by this switch, the setting of AREA0 (pin 53) and AREA1 (pin 54) is invalid.</p>	CHINA_BAND	Destination region	0	Set by AREA0 and AREA1 pins	1	China									
CHINA_BAND	Destination region															
0	Set by AREA0 and AREA1 pins															
1	China															
IFSEL1 IFSEL2	<p>This switch sets an intermediate frequency in the AM band. Set it as follows:</p> <table border="1" data-bbox="407 556 1360 804"> <thead> <tr> <th>IFSEL1</th> <th>IFSEL2</th> <th>Intermediate Frequency of AM Band</th> </tr> </thead> <tbody> <tr> <td>0</td> <td>0</td> <td>450 kHz</td> </tr> <tr> <td>1</td> <td>0</td> <td>459 kHz/460 kHz</td> </tr> <tr> <td>0</td> <td>1</td> <td>10.71 MHz</td> </tr> <tr> <td>1</td> <td>1</td> <td>Invalid setting. The intermediate frequency is 450 kHz.</td> </tr> </tbody> </table> <p>(0: Open, 1: Short) When inputting an intermediate frequency to the FMIFC/AMIFC pin (pin 17) when the intermediate frequency is set to “10.71 kHz”, convert the frequency to 450 kHz before inputting.</p>	IFSEL1	IFSEL2	Intermediate Frequency of AM Band	0	0	450 kHz	1	0	459 kHz/460 kHz	0	1	10.71 MHz	1	1	Invalid setting. The intermediate frequency is 450 kHz.
IFSEL1	IFSEL2	Intermediate Frequency of AM Band														
0	0	450 kHz														
1	0	459 kHz/460 kHz														
0	1	10.71 MHz														
1	1	Invalid setting. The intermediate frequency is 450 kHz.														
MEMSEL	<p>This switch sets the momentary key for preset memory manipulation. Set it as follows:</p> <table border="1" data-bbox="407 989 1360 1192"> <thead> <tr> <th>MEMSEL</th> <th>Preset memory selection operation</th> <th>Auto store memory operation</th> </tr> </thead> <tbody> <tr> <td>0</td> <td>M1 to M5 key +5 key</td> <td>AUTO STORE key</td> </tr> <tr> <td>1</td> <td>MEMORY UP key</td> <td>MEMORY key (hold down for 2 seconds or longer)</td> </tr> </tbody> </table> <p>(0: Open, 1: Short)</p>	MEMSEL	Preset memory selection operation	Auto store memory operation	0	M1 to M5 key +5 key	AUTO STORE key	1	MEMORY UP key	MEMORY key (hold down for 2 seconds or longer)						
MEMSEL	Preset memory selection operation	Auto store memory operation														
0	M1 to M5 key +5 key	AUTO STORE key														
1	MEMORY UP key	MEMORY key (hold down for 2 seconds or longer)														
SD_IF	<p>This switch selects the method for detecting a station. Set it as follows:</p> <table border="1" data-bbox="407 1318 1360 1451"> <thead> <tr> <th>SD_IF</th> <th>Station detection method</th> </tr> </thead> <tbody> <tr> <td>0</td> <td>Station detection using frequency counter</td> </tr> <tr> <td>1</td> <td>Station detection using frequency counter and SD signal</td> </tr> </tbody> </table> <p>(0: Open, 1: Short)</p>	SD_IF	Station detection method	0	Station detection using frequency counter	1	Station detection using frequency counter and SD signal									
SD_IF	Station detection method															
0	Station detection using frequency counter															
1	Station detection using frequency counter and SD signal															
STOPSEL	<p>This switch sets a momentary key used to cancel alarm sound output. It is also used to lock or unlock a key. Set it as follows:</p> <table border="1" data-bbox="407 1606 1360 1810"> <thead> <tr> <th>STOPSEL</th> <th>Alarm sound output canceling operation</th> <th>Key locking/unlocking</th> </tr> </thead> <tbody> <tr> <td>0</td> <td>STOP key</td> <td>STOP key and MODE key (pressed simultaneously)</td> </tr> <tr> <td>1</td> <td>ALARM key</td> <td>ALARM key and MODE key (pressed simultaneously)</td> </tr> </tbody> </table> <p>(0: Open, 1: Short)</p>	STOPSEL	Alarm sound output canceling operation	Key locking/unlocking	0	STOP key	STOP key and MODE key (pressed simultaneously)	1	ALARM key	ALARM key and MODE key (pressed simultaneously)						
STOPSEL	Alarm sound output canceling operation	Key locking/unlocking														
0	STOP key	STOP key and MODE key (pressed simultaneously)														
1	ALARM key	ALARM key and MODE key (pressed simultaneously)														

Initialization Diode	Function Description						
TV_ENA	<p>This switch is used to select whether a TV band is received. Setting of this switch is valid only when Japan is selected as the destination region. Set it as follows:</p> <table border="1" data-bbox="483 306 1438 436"> <thead> <tr> <th data-bbox="483 306 675 350">TV_ENA</th> <th data-bbox="675 306 1438 350">Receivable band when Japan is selected as region</th> </tr> </thead> <tbody> <tr> <td data-bbox="483 350 675 394">0</td> <td data-bbox="675 350 1438 394">FM/AM</td> </tr> <tr> <td data-bbox="483 394 675 436">1</td> <td data-bbox="675 394 1438 436">FM/AM/TV</td> </tr> </tbody> </table> <p>(0: Open, 1: Short)</p>	TV_ENA	Receivable band when Japan is selected as region	0	FM/AM	1	FM/AM/TV
TV_ENA	Receivable band when Japan is selected as region						
0	FM/AM						
1	FM/AM/TV						

2.4.2 Momentary key

Two momentary keys can be pressed simultaneously only in the following combination.

- **STOP** and **MODE** keys to lock or unlock keys
- **ALARM** and **MODE** keys to lock or unlock keys
- **UP** and **DOWN** keys during seek up/down

Any other combinations of keys is invalid when pressed simultaneously.

The chattering wait time is 48 to 64 ms.

The functions of the momentary keys are explained below (in alphabetical order).

Momentary Key	Function Description												
<p style="text-align: center;">ALARM</p>	<p>This key sets or cancels the alarm and cancels alarm sound output. This key is valid when the watch function is used (when a high level is input to the CLKENA pin (pin 56)).</p> <ul style="list-style-type: none"> • When initialization diode switch STOPSEL = 0 For setting or canceling alarm • When initialization diode switch STOPSEL = 1 For setting or canceling alarm and canceling alarm sound output <p>(1) Setting/canceling alarm By pressing the ALARM key, the alarm is set at specified time. When the ALARM key is pressed again with the alarm set, the alarm is canceled. While the time is being adjusted and while the alarm time is being set, however, the alarm cannot be set or canceled. For an explanation of how to set the alarm time, refer to the description on the MODE key.</p> <p>(2) Canceling alarm sound output (when STOPSEL = 1) By pressing the ALARM key when the alarm sound is being output, the output of the alarm can be stopped.</p> <p>(3) Locking momentary key (when STOPSEL = 1) The momentary key is locked when the MODE key is pressed while the ALARM key is held down. For key locking, refer to the description on the MODE key.</p>												
<p style="text-align: center;">AUTO STORE</p>	<p>This is a key for auto store memory. It is valid when the radio is ON and the initialization diode switch MEMSEL = 0.</p> <ul style="list-style-type: none"> • Auto store memory The auto store memory operation is started when the AUTO STORE key is pressed. This operation automatically searches a station and writes it to the preset memory. During the auto store memory operation, the frequency being sought is displayed. Searching is started from the lowest frequency in a band, and is completed when the highest frequency is found. When stations are found they are stored started from preset M1. When stations have been stored up to M10, the auto store memory operation is completed. If the highest frequency is found before a station is written to M10, the auto store memory operation is stopped at that point. The operation of each key during auto store memory operation is as follows: <table border="1" data-bbox="500 1266 1437 1686"> <thead> <tr> <th data-bbox="506 1274 691 1308">Key</th> <th data-bbox="691 1274 1430 1308">Function Description</th> </tr> </thead> <tbody> <tr> <td data-bbox="506 1308 691 1514"> <p style="text-align: center;">AUTO STORE</p> </td> <td data-bbox="691 1308 1430 1514"> Stops auto store memory operation. <ul style="list-style-type: none"> • If station is written to preset memory as result of auto store memory operation, preset M1 is received. • If no station is written to preset memory as result of auto store memory operation, frequency or preset station, when auto store memory operation is started, is received. </td> </tr> <tr> <td data-bbox="506 1514 691 1560"> <p style="text-align: center;">BAND</p> </td> <td data-bbox="691 1514 1430 1560"> Stops auto store memory operation and changes band. </td> </tr> <tr> <td data-bbox="506 1560 691 1606"> <p style="text-align: center;">ALARM</p> </td> <td data-bbox="691 1560 1430 1606"> Performs operation of pressed key. </td> </tr> <tr> <td data-bbox="506 1606 691 1652"> <p style="text-align: center;">CHECK</p> </td> <td data-bbox="691 1606 1430 1652"> Auto store memory operation continues. </td> </tr> <tr> <td data-bbox="506 1652 691 1686"> <p style="text-align: center;">STOP</p> </td> <td data-bbox="691 1652 1430 1686"></td> </tr> </tbody> </table> <p>Any key other than above is invalid.</p>	Key	Function Description	<p style="text-align: center;">AUTO STORE</p>	Stops auto store memory operation. <ul style="list-style-type: none"> • If station is written to preset memory as result of auto store memory operation, preset M1 is received. • If no station is written to preset memory as result of auto store memory operation, frequency or preset station, when auto store memory operation is started, is received. 	<p style="text-align: center;">BAND</p>	Stops auto store memory operation and changes band.	<p style="text-align: center;">ALARM</p>	Performs operation of pressed key.	<p style="text-align: center;">CHECK</p>	Auto store memory operation continues.	<p style="text-align: center;">STOP</p>	
Key	Function Description												
<p style="text-align: center;">AUTO STORE</p>	Stops auto store memory operation. <ul style="list-style-type: none"> • If station is written to preset memory as result of auto store memory operation, preset M1 is received. • If no station is written to preset memory as result of auto store memory operation, frequency or preset station, when auto store memory operation is started, is received. 												
<p style="text-align: center;">BAND</p>	Stops auto store memory operation and changes band.												
<p style="text-align: center;">ALARM</p>	Performs operation of pressed key.												
<p style="text-align: center;">CHECK</p>	Auto store memory operation continues.												
<p style="text-align: center;">STOP</p>													

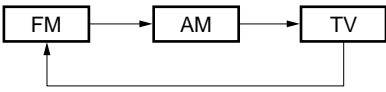
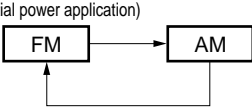
Momentary Key	Function Description						
<p>BAND</p>	<p>This key is used to select a band. It is valid when the radio is ON. Each time the BAND key has been pressed, the band is changed as follows:</p> <ul style="list-style-type: none"> • If Japan is selected as destination region and if initialization diode switch TV_ENA = 1 <div style="text-align: center;"> <p>(On initial power application)</p>  <pre> graph LR FM[FM] --> AM[AM] AM --> TV[TV] TV --> FM </pre> </div> <ul style="list-style-type: none"> • Other than above <div style="text-align: center;"> <p>(On initial power application)</p>  <pre> graph LR FM[FM] --> AM[AM] AM --> FM </pre> </div>						
<p>CHECK</p>	<p>This key is used to test lighting of the LCD before shipment. By pressing the CHECK key, all the segments of the LCD lights for 20 seconds. If the CHECK key is pressed again while the LCD is lit, the test is stopped. Any key other than the CHECK key is invalid during the testing of LCD lighting.</p>						
<p>M1 – M5</p>	<p>These keys are used to call a preset station and to write data to the preset memories. They are valid when the radio is ON and initialization diode switch MEMSEL = 0.</p> <p>(1) Calling preset memory By pressing any of the M1 through M5 keys, the corresponding preset station can be called. A preset memory number is indicated for 0.5 second, and the corresponding frequency is selected. Ten preset memories, M1 through M10, each corresponding to a preset station, are available. To call preset memories M6 through M10, or to write data to these preset memories, refer to the description of the +5 Key.</p> <p>(2) Writing preset memory The contents of a specified preset memory are written when one of the keys M1 to M5 is pressed in combination with the MEMORY key. For how to write data to the preset memory, refer to the description of the MEMORY key.</p> <p>When initialization diode switch MEMSEL = 1, the M1 key functions as the MEMORY UP Key.</p>						
<p>MEMORY</p>	<p>This key is for writing data to the preset memory and for auto store memory. It is valid when the radio is ON.</p> <ul style="list-style-type: none"> • When initialization diode switch MEMSEL = 0 For writing preset memory • When initialization diode switch MEMSEL = 1 For writing preset memory and auto store memory <p>The operation is as follows when initialization diode switch MEMSEL = 1.</p> <table border="1" data-bbox="422 1717 1344 1848"> <thead> <tr> <th>MEMORY key is held down for:</th> <th>Operation</th> </tr> </thead> <tbody> <tr> <td>Less than 2 seconds</td> <td>Preset memory write</td> </tr> <tr> <td>2 seconds or longer</td> <td>Auto store memory</td> </tr> </tbody> </table>	MEMORY key is held down for:	Operation	Less than 2 seconds	Preset memory write	2 seconds or longer	Auto store memory
MEMORY key is held down for:	Operation						
Less than 2 seconds	Preset memory write						
2 seconds or longer	Auto store memory						

Momentary Key	Function Description
<p style="text-align: center;">MEMORY</p>	<p>(1) Preset memory writing</p> <p>By pressing the MEMORY key, the preset memory is enabled to be written for 10 seconds. Write data to the preset memory in the following sequence:</p> <ul style="list-style-type: none"> • When initialization diode switch MEMSEL = 0 <div style="border: 1px dashed black; padding: 5px; margin-bottom: 10px;"> <p>Select the frequency to be stored to the memory by using the UP and DOWN keys.</p> </div> <p style="text-align: center;">↓</p> <div style="border: 1px dashed black; padding: 5px; margin-bottom: 10px;"> <p>Press the MEMORY key to enable the preset memory to be written.</p> </div> <p style="text-align: center;">↓</p> <div style="border: 1px dashed black; padding: 5px;"> <p>Press any of the M1 through M5 keys in accordance with the preset memory to which data is to be written, and write data to the preset memory.</p> </div> <ul style="list-style-type: none"> • When initialization diode switch MEMSEL = 1 <div style="border: 1px dashed black; padding: 5px; margin-bottom: 10px;"> <p>Select the frequency to be stored in the memory by using the UP and DOWN key.</p> </div> <p style="text-align: center;">↓</p> <div style="border: 1px dashed black; padding: 5px; margin-bottom: 10px;"> <p>Enable the preset memory to be written by pressing the MEMORY key. The preset memory holding the station received last plus one is automatically selected as the preset memory to be written.</p> </div> <p style="text-align: center;">↓</p> <div style="border: 1px dashed black; padding: 5px; margin-bottom: 10px;"> <p>Select the preset memory to be written, by using the MEMORY UP key.</p> </div> <p style="text-align: center;">↓</p> <div style="border: 1px dashed black; padding: 5px;"> <p>Press the MEMORY key again to write data to the preset memory.</p> </div>

Momentary Key	Function Description												
<p>MEMORY</p>	<p>The operation of each key is as follows depending on the write status of the preset memory.</p> <table border="1" data-bbox="407 264 1357 1165"> <thead> <tr> <th data-bbox="407 264 662 304">Key</th> <th data-bbox="665 264 1357 304">Function description</th> </tr> </thead> <tbody> <tr> <td data-bbox="407 308 662 478"> <p>M1 – M5</p> </td> <td data-bbox="665 308 1357 478"> <ul style="list-style-type: none"> When initialization diode switch MEMSEL = 0 Data is written to a preset memory and the preset memory write status is released. When initialization diode switch MEMSEL = 1 This key is invalid. </td> </tr> <tr> <td data-bbox="407 483 662 653"> <p>MEMORY UP</p> </td> <td data-bbox="665 483 1357 653"> <ul style="list-style-type: none"> When initialization diode switch MEMSEL = 0 This key is invalid. When initialization diode switch MEMSEL = 1 Increments the preset memory to be written by one station. Preset memory M1 is selected next if preset memory M10 is selected. </td> </tr> <tr> <td data-bbox="407 657 662 827"> <p>MEMORY</p> </td> <td data-bbox="665 657 1357 827"> <ul style="list-style-type: none"> When initialization diode switch MEMSEL = 0 Releases the preset memory write status. When initialization diode switch MEMSEL = 1 Writes data to a preset memory and releases the preset memory write status. </td> </tr> <tr> <td data-bbox="407 831 662 940"> <p>AUTO STORE BAND UP / DOWN</p> </td> <td data-bbox="665 831 1357 940"> <p>Releases the preset memory write status, and performs the operation of the key pressed.</p> </td> </tr> <tr> <td data-bbox="407 945 662 1165"> <p>ALARM CHECK MODE +5 STOP SLEEP</p> </td> <td data-bbox="665 945 1357 1165"> <p>Performs the operation of the key pressed. The preset memory write status continues.</p> </td> </tr> </tbody> </table> <p>(2) Auto store memory (when MEMSEL = 1)</p> <p>The auto store memory operation is started by holding down the MEMORY key for 2 seconds or longer.</p> <p>During auto store memory operation, this key operates as the AUTO STORE key.</p> <p>For the auto store memory operation, refer to the description on the AUTO STORE key.</p>	Key	Function description	<p>M1 – M5</p>	<ul style="list-style-type: none"> When initialization diode switch MEMSEL = 0 Data is written to a preset memory and the preset memory write status is released. When initialization diode switch MEMSEL = 1 This key is invalid. 	<p>MEMORY UP</p>	<ul style="list-style-type: none"> When initialization diode switch MEMSEL = 0 This key is invalid. When initialization diode switch MEMSEL = 1 Increments the preset memory to be written by one station. Preset memory M1 is selected next if preset memory M10 is selected. 	<p>MEMORY</p>	<ul style="list-style-type: none"> When initialization diode switch MEMSEL = 0 Releases the preset memory write status. When initialization diode switch MEMSEL = 1 Writes data to a preset memory and releases the preset memory write status. 	<p>AUTO STORE BAND UP / DOWN</p>	<p>Releases the preset memory write status, and performs the operation of the key pressed.</p>	<p>ALARM CHECK MODE +5 STOP SLEEP</p>	<p>Performs the operation of the key pressed. The preset memory write status continues.</p>
Key	Function description												
<p>M1 – M5</p>	<ul style="list-style-type: none"> When initialization diode switch MEMSEL = 0 Data is written to a preset memory and the preset memory write status is released. When initialization diode switch MEMSEL = 1 This key is invalid. 												
<p>MEMORY UP</p>	<ul style="list-style-type: none"> When initialization diode switch MEMSEL = 0 This key is invalid. When initialization diode switch MEMSEL = 1 Increments the preset memory to be written by one station. Preset memory M1 is selected next if preset memory M10 is selected. 												
<p>MEMORY</p>	<ul style="list-style-type: none"> When initialization diode switch MEMSEL = 0 Releases the preset memory write status. When initialization diode switch MEMSEL = 1 Writes data to a preset memory and releases the preset memory write status. 												
<p>AUTO STORE BAND UP / DOWN</p>	<p>Releases the preset memory write status, and performs the operation of the key pressed.</p>												
<p>ALARM CHECK MODE +5 STOP SLEEP</p>	<p>Performs the operation of the key pressed. The preset memory write status continues.</p>												

Momentary Key	Function Description
<p>MEMORY UP</p>	<p>This key is used to call and write a preset memory. It is valid when the radio is ON and initialization diode switch MEMSEL = 1.</p> <p>(1) Calling preset memory Each time the MEMORY UP is pressed, the preset station is incremented by one and called up. The preset memory number is displayed for 0.5 second, and the corresponding frequency is received.</p> <ul style="list-style-type: none"> When a preset station is already selected, the preset station is incremented by one and selected. Example: When preset M3 is already selected, this is incremented by one and M4 is selected. When preset M10 is the current selection, M1 is selected next. If this key is pressed while no preset station is selected, preset M1 is selected. <p>(2) Writing preset memory Data is written to a specified preset memory when this key is used in combination with the MEMORY key. For an explanation of how to write data to a preset memory, refer to the description of the MEMORY key. When initialization diode switch MEMSEL = 0, this key functions as the M1 key.</p>
<p>MODE</p>	<p>This key is used to switch the display and the watch adjust mode. It is valid when the watch function is used (when a high level is input to the CLKENA pin (pin 56)).</p> <ul style="list-style-type: none"> When radio is ON: For switching display When radio is OFF: For switching watch adjust mode <p>(1) Display switching (when radio is ON) Each time the MODE key is pressed, the frequency display or watch display is alternately selected.</p> <p>(2) Watch adjust mode switching (when radio is OFF) Each time the MODE key is pressed, the mode is changed as follows:</p> <div data-bbox="581 1108 1370 1243" data-label="Diagram"> <pre> graph LR A[Watch display] --> B[Alarm time setting mode] B --> C[Watch adjust mode] C --> A </pre> </div> <p>For an explanation of how to adjust the time, refer to the description of the UP and DOWN keys.</p> <p>The momentary keys are locked by the following key operation:</p> <ul style="list-style-type: none"> When STOPSEL = 0: Press the STOP key and then the MODE key twice. When STOPSEL = 1: Press the ALARM key and then the MODE key twice. <p>While keys are locked, no key operation other than that to manipulate key locking is valid. By repeating the key locking operation while the keys are locked, the keys are unlocked. If the momentary keys are locked by input to the KEYLOCK pin (pin 14), the keys cannot be unlocked by a key operation.</p>

Momentary Key	Function Description						
<div style="border: 1px solid black; padding: 2px; display: inline-block; margin-bottom: 5px;">+5</div>	<p>This key is used to select preset memory M6 to M10 in combination with the <div style="border: 1px solid black; padding: 2px; display: inline-block; margin-bottom: 2px;">M1</div> to <div style="border: 1px solid black; padding: 2px; display: inline-block; margin-bottom: 2px;">M5</div> keys. It is valid when the radio is ON and initialization diode switch MEMSEL = 0.</p> <p>When the <div style="border: 1px solid black; padding: 2px; display: inline-block; margin-bottom: 2px;">+5</div> key is pressed, the preset shift status is set.</p> <p>In this status, operating the <div style="border: 1px solid black; padding: 2px; display: inline-block; margin-bottom: 2px;">M1</div> to <div style="border: 1px solid black; padding: 2px; display: inline-block; margin-bottom: 2px;">M5</div> key manipulates preset memory M6 to M10. The preset shift status is released on completion of the operation. If the <div style="border: 1px solid black; padding: 2px; display: inline-block; margin-bottom: 2px;">+5</div> key is pressed again in the preset shift status, the preset shift status is released.</p>						
<div style="border: 1px solid black; padding: 2px; display: inline-block;">SLEEP</div>	<p>This key is used to set the sleep timer.</p> <p>It is valid when the radio is ON.</p> <p>When the <div style="border: 1px solid black; padding: 2px; display: inline-block; margin-bottom: 2px;">SLEEP</div> key is pressed, the remaining time of the sleep timer is displayed for 10 seconds. The initial value of the remaining time of the sleep timer is 120 minutes.</p> <p>If the <div style="border: 1px solid black; padding: 2px; display: inline-block; margin-bottom: 2px;">SLEEP</div> key is pressed while the remaining time of the sleep timer is displayed, the time is decremented in steps of 30 minutes.</p> <p>(Example 60 minutes → 30 minutes, 45 minutes → 30 minutes)</p> <p>If the remaining time reaches 0 minutes, the sleep timer is released.</p> <p>If the radio is turned OFF (CE = low level) while the sleep timer is valid, the sleep timer is released.</p>						
<div style="border: 1px solid black; padding: 2px; display: inline-block;">STOP</div>	<p>This key is used to cancel output of the alarm sound.</p> <p>It is valid when the watch function is used (when a high level is input to the CLKENA pin (pin 56)).</p> <p>It is valid when initialization diode switch STOPSEL = 0.</p> <p>(1) Stopping alarm sound output</p> <p>By pressing the <div style="border: 1px solid black; padding: 2px; display: inline-block; margin-bottom: 2px;">STOP</div> key while the alarm sound is output, output of the alarm sound can be stopped.</p> <p>(2) Locking momentary keys (when STOPSEL = 0)</p> <p>Momentary keys can be locked by pressing the <div style="border: 1px solid black; padding: 2px; display: inline-block; margin-bottom: 2px;">STOP</div> key and then the <div style="border: 1px solid black; padding: 2px; display: inline-block; margin-bottom: 2px;">MODE</div> key twice.</p> <p>For an explanation of how to lock the keys, refer to the description of the <div style="border: 1px solid black; padding: 2px; display: inline-block; margin-bottom: 2px;">MODE</div> key.</p>						
<div style="border: 1px solid black; padding: 2px; display: inline-block; margin-bottom: 5px;">UP</div> <div style="border: 1px solid black; padding: 2px; display: inline-block;">DOWN</div>	<p>This key is used to increment/decrement the receive frequency and adjust the time.</p> <ul style="list-style-type: none"> • When radio is ON: To increment/decrement receive frequency • When radio is OFF: To adjust time and set alarm time <p>(1) Incrementing/decrementing receive frequency (when radio is ON)</p> <table border="1" data-bbox="436 1304 1328 1434" style="width: 100%; border-collapse: collapse;"> <thead> <tr> <th style="text-align: left;">Time to hold down <div style="border: 1px solid black; padding: 2px; display: inline-block; margin-bottom: 2px;">UP</div> or <div style="border: 1px solid black; padding: 2px; display: inline-block; margin-bottom: 2px;">DOWN</div> key</th> <th style="text-align: left;">Operation</th> </tr> </thead> <tbody> <tr> <td style="text-align: center;">Less than 0.5 second</td> <td style="text-align: center;">Increments/decrements 1 channel</td> </tr> <tr> <td style="text-align: center;">0.5 second or longer</td> <td style="text-align: center;">Seek up/down</td> </tr> </tbody> </table>	Time to hold down <div style="border: 1px solid black; padding: 2px; display: inline-block; margin-bottom: 2px;">UP</div> or <div style="border: 1px solid black; padding: 2px; display: inline-block; margin-bottom: 2px;">DOWN</div> key	Operation	Less than 0.5 second	Increments/decrements 1 channel	0.5 second or longer	Seek up/down
Time to hold down <div style="border: 1px solid black; padding: 2px; display: inline-block; margin-bottom: 2px;">UP</div> or <div style="border: 1px solid black; padding: 2px; display: inline-block; margin-bottom: 2px;">DOWN</div> key	Operation						
Less than 0.5 second	Increments/decrements 1 channel						
0.5 second or longer	Seek up/down						

Momentary Key	Function Description																										
<div style="border: 1px solid black; padding: 2px; display: inline-block; margin-bottom: 5px;">UP</div> <div style="border: 1px solid black; padding: 2px; display: inline-block;">DOWN</div>	<p>The operation of each key is as follows during seek up/down operation.</p> <table border="1" data-bbox="516 264 1438 863"> <thead> <tr> <th data-bbox="516 264 708 306">Key</th> <th data-bbox="708 264 1438 306">Function description</th> </tr> </thead> <tbody> <tr> <td data-bbox="516 306 708 449"> <div style="border: 1px solid black; padding: 2px; display: inline-block;">UP</div> </td> <td data-bbox="708 306 1438 449"> <ul style="list-style-type: none"> • If the key is pressed while the seek up operation is in progress, the seek operation is stopped, and the frequency at which the seek operation was started is received. • During the seek down operation, the seek up operation is started. </td> </tr> <tr> <td data-bbox="516 449 708 592"> <div style="border: 1px solid black; padding: 2px; display: inline-block;">DOWN</div> </td> <td data-bbox="708 449 1438 592"> <ul style="list-style-type: none"> • If the key is pressed while the seek down operation is in progress, the seek operation is stopped and the frequency at which the seek operation was started is received. • During the seek up operation, the seek down operation is started. </td> </tr> <tr> <td data-bbox="516 592 708 705"> <div style="border: 1px solid black; padding: 2px; display: inline-block;">BAND</div> <div style="border: 1px solid black; padding: 2px; display: inline-block; margin-right: 5px;">M1</div> ~ <div style="border: 1px solid black; padding: 2px; display: inline-block; margin-right: 5px;">M5</div> <div style="border: 1px solid black; padding: 2px; display: inline-block;">MEMORY UP</div> </td> <td data-bbox="708 592 1438 705">Stops the seek operation and performs the operation of the key pressed.</td> </tr> <tr> <td data-bbox="516 705 708 863"> <div style="border: 1px solid black; padding: 2px; display: inline-block; margin-bottom: 2px;">ALARM</div> <div style="border: 1px solid black; padding: 2px; display: inline-block; margin-bottom: 2px;">CHECK</div> <div style="border: 1px solid black; padding: 2px; display: inline-block; margin-bottom: 2px;">+5</div> <div style="border: 1px solid black; padding: 2px; display: inline-block;">STOP</div> </td> <td data-bbox="708 705 1438 863"> Performs the operation of the key pressed. The seek operation continues. </td> </tr> </tbody> </table> <p>Any key other than above is invalid.</p> <p>(2) Adjusting time and setting alarm time (when radio is OFF)</p> <p>By pressing the <div style="border: 1px solid black; padding: 2px; display: inline-block;">UP</div> or <div style="border: 1px solid black; padding: 2px; display: inline-block;">DOWN</div> key in the alarm time setting mode or time adjust mode, the time can be adjusted.</p> <p>The following operation is performed in the alarm time setting mode and time adjust mode.</p> <table border="1" data-bbox="516 1073 1438 1545"> <thead> <tr> <th data-bbox="516 1073 643 1142">Key</th> <th data-bbox="643 1073 805 1142">Digit to be adjusted</th> <th data-bbox="805 1073 967 1142">Time to hold down key</th> <th data-bbox="967 1073 1438 1142">Operation</th> </tr> </thead> <tbody> <tr> <td data-bbox="516 1142 643 1356" rowspan="2"> <div style="border: 1px solid black; padding: 2px; display: inline-block;">UP</div> </td> <td data-bbox="643 1142 805 1356" rowspan="2">Minute digit</td> <td data-bbox="805 1142 967 1220">Less than 0.5 second</td> <td data-bbox="967 1142 1438 1220">Increments time by 1 minute each time the key is pressed.</td> </tr> <tr> <td data-bbox="805 1220 967 1356">0.5 second or longer</td> <td data-bbox="967 1220 1438 1356">Fast-forward the time at a rate of 8 minutes/second until the key is released. No carry to the hour digit occurs. Each time the minute digit has been adjusted, the second count value is reset.</td> </tr> <tr> <td data-bbox="516 1356 643 1545" rowspan="2"> <div style="border: 1px solid black; padding: 2px; display: inline-block;">DOWN</div> </td> <td data-bbox="643 1356 805 1545" rowspan="2">Hour digit</td> <td data-bbox="805 1356 967 1434">Less than 0.5 second</td> <td data-bbox="967 1356 1438 1434">Increments time by 1 hour each time the key is pressed.</td> </tr> <tr> <td data-bbox="805 1434 967 1545">0.5 second or longer</td> <td data-bbox="967 1434 1438 1545">Fast-forwards the time at a rate of 4 hours/second until the key is released. The minute digit and second count value are not affected.</td> </tr> </tbody> </table>	Key	Function description	<div style="border: 1px solid black; padding: 2px; display: inline-block;">UP</div>	<ul style="list-style-type: none"> • If the key is pressed while the seek up operation is in progress, the seek operation is stopped, and the frequency at which the seek operation was started is received. • During the seek down operation, the seek up operation is started. 	<div style="border: 1px solid black; padding: 2px; display: inline-block;">DOWN</div>	<ul style="list-style-type: none"> • If the key is pressed while the seek down operation is in progress, the seek operation is stopped and the frequency at which the seek operation was started is received. • During the seek up operation, the seek down operation is started. 	<div style="border: 1px solid black; padding: 2px; display: inline-block;">BAND</div> <div style="border: 1px solid black; padding: 2px; display: inline-block; margin-right: 5px;">M1</div> ~ <div style="border: 1px solid black; padding: 2px; display: inline-block; margin-right: 5px;">M5</div> <div style="border: 1px solid black; padding: 2px; display: inline-block;">MEMORY UP</div>	Stops the seek operation and performs the operation of the key pressed.	<div style="border: 1px solid black; padding: 2px; display: inline-block; margin-bottom: 2px;">ALARM</div> <div style="border: 1px solid black; padding: 2px; display: inline-block; margin-bottom: 2px;">CHECK</div> <div style="border: 1px solid black; padding: 2px; display: inline-block; margin-bottom: 2px;">+5</div> <div style="border: 1px solid black; padding: 2px; display: inline-block;">STOP</div>	Performs the operation of the key pressed. The seek operation continues.	Key	Digit to be adjusted	Time to hold down key	Operation	<div style="border: 1px solid black; padding: 2px; display: inline-block;">UP</div>	Minute digit	Less than 0.5 second	Increments time by 1 minute each time the key is pressed.	0.5 second or longer	Fast-forward the time at a rate of 8 minutes/second until the key is released. No carry to the hour digit occurs. Each time the minute digit has been adjusted, the second count value is reset.	<div style="border: 1px solid black; padding: 2px; display: inline-block;">DOWN</div>	Hour digit	Less than 0.5 second	Increments time by 1 hour each time the key is pressed.	0.5 second or longer	Fast-forwards the time at a rate of 4 hours/second until the key is released. The minute digit and second count value are not affected.
Key	Function description																										
<div style="border: 1px solid black; padding: 2px; display: inline-block;">UP</div>	<ul style="list-style-type: none"> • If the key is pressed while the seek up operation is in progress, the seek operation is stopped, and the frequency at which the seek operation was started is received. • During the seek down operation, the seek up operation is started. 																										
<div style="border: 1px solid black; padding: 2px; display: inline-block;">DOWN</div>	<ul style="list-style-type: none"> • If the key is pressed while the seek down operation is in progress, the seek operation is stopped and the frequency at which the seek operation was started is received. • During the seek up operation, the seek down operation is started. 																										
<div style="border: 1px solid black; padding: 2px; display: inline-block;">BAND</div> <div style="border: 1px solid black; padding: 2px; display: inline-block; margin-right: 5px;">M1</div> ~ <div style="border: 1px solid black; padding: 2px; display: inline-block; margin-right: 5px;">M5</div> <div style="border: 1px solid black; padding: 2px; display: inline-block;">MEMORY UP</div>	Stops the seek operation and performs the operation of the key pressed.																										
<div style="border: 1px solid black; padding: 2px; display: inline-block; margin-bottom: 2px;">ALARM</div> <div style="border: 1px solid black; padding: 2px; display: inline-block; margin-bottom: 2px;">CHECK</div> <div style="border: 1px solid black; padding: 2px; display: inline-block; margin-bottom: 2px;">+5</div> <div style="border: 1px solid black; padding: 2px; display: inline-block;">STOP</div>	Performs the operation of the key pressed. The seek operation continues.																										
Key	Digit to be adjusted	Time to hold down key	Operation																								
<div style="border: 1px solid black; padding: 2px; display: inline-block;">UP</div>	Minute digit	Less than 0.5 second	Increments time by 1 minute each time the key is pressed.																								
		0.5 second or longer	Fast-forward the time at a rate of 8 minutes/second until the key is released. No carry to the hour digit occurs. Each time the minute digit has been adjusted, the second count value is reset.																								
<div style="border: 1px solid black; padding: 2px; display: inline-block;">DOWN</div>	Hour digit	Less than 0.5 second	Increments time by 1 hour each time the key is pressed.																								
		0.5 second or longer	Fast-forwards the time at a rate of 4 hours/second until the key is released. The minute digit and second count value are not affected.																								

2.5 Alarm Function

The alarm function outputs an alarm sound at specified alarm time every day.

Only one alarm time can be set.

When the watch function is not selected on initialization, the alarm function cannot be used.

For initialization of the watch function, refer to the description on the CLKENA pin (pin 56).

(1) Setting of alarm time

To set alarm time, select the alarm time setting mode when the radio is OFF.

Each time the **MODE** key is pressed when the radio is OFF, the mode is changed as follows:

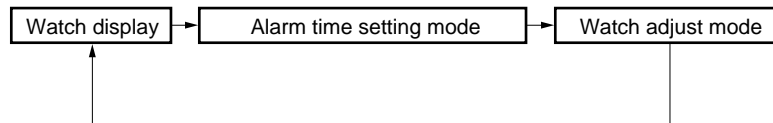

The alarm time can be adjusted by using the **UP** and **DOWN** key in the alarm time setting mode.

The operation is as follows in the alarm time setting mode.

Key	Digit to Be Adjusted	Time to Hold Down Key	Operation
UP	Minute digit	Less than 0.5 second	Increments the minute by one each time the key is pressed.
		0.5 second or longer	Increments the minute at a rate of 8 minutes/second until key is released.
DOWN	Hour digit	Less than 0.5 second	Increments the hour by one each time the key is pressed.
		0.5 second or longer	Increments the hour at a rate of 4 hours/second until the key is released.

The initial alarm time on power application is “00:00” (midnight).

(2) Setting/releasing alarm

By pressing the **ALARM** key, the alarm is set for the time set.

When the time has reached the alarm time set, output of the alarm sound is started.

The alarm can be released by pressing the **ALARM** key again while the alarm is set.

However, the alarm cannot be set or released in the time adjust mode or alarm time setting mode.

(3) Canceling alarm sound output

Output of the alarm sound is stopped if the key for canceling the alarm sound output is pressed while the alarm sound is being output.

The following key is used as the key for canceling the alarm sound output, depending on the initialization.

- When initialization diode switch STOPSEL = 0

STOP key

- When initialization diode switch STOPSEL = 1

ALARM key

The output of the alarm sound continues for 10 minutes from the start, or until it is canceled.

2.6 Key Lock Function

The key lock function is to lock the momentary keys and invalidate key operations.

The keys are locked by input to the KEYLOCK pin (pin 14).

When the input to the KEYLOCK pin is low, the keys can also be locked by a key operation.

(1) Locking keys by input to KEYLOCK pin (pin 14)

The momentary keys can be locked by input to the KEYLOCK pin.

The operation of the momentary keys can be manipulated as follows by the pin input.

- High-level input
Locks keys and invalidates all key operations.
Also invalidates the key operation to unlock the keys.
- Low-level input
All the keys perform normally when the keys are pressed.
At this time, the keys can be locked or unlocked by a key operation.

(2) Locking keys by key operation

The keys can be locked or unlocked by a key operation when the input to the KEYLOCK pin (pin 14) is low. If the input to the KEYLOCK pin is high, however, the locked keys cannot be unlocked by a key operation.

The momentary keys are locked by performing the following key lock operation.

- When the keys are locked, they are unlocked when the key lock operation is performed again.
- When the keys are locked, all key operations other than that to unlock the key is invalid.

The following key lock operation is performed, depending on initialization.

- **When initialization diode switch STOPSEL = 0**
Press the **STOP** key and then the **MODE** key twice.
- **When initialization diode switch STOPSEL =1**
Press the **ALARM** key and then the **MODE** key twice.

3. LCD DISPLAY

3.1 LCD Panel

The configuration of the LCD panel is shown below.



3.2 Font



3.3 LCD Pattern

(1) Connection of segment lines

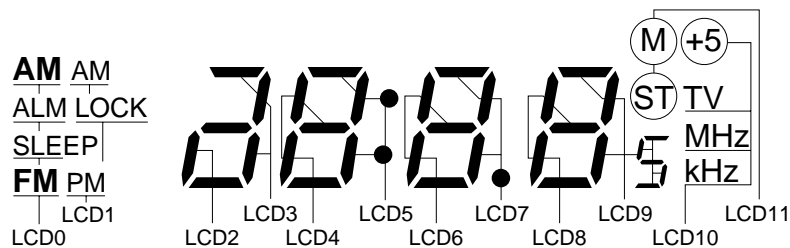

(2) Connection of common lines

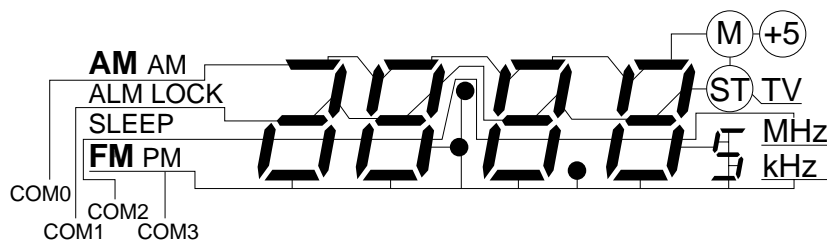

3.4 LCD Pin Assignment

Table 3-1 shows assignment of the LCD pins.

<1> through <4> in the figure and table below indicate the column positions of the 7-segment digits. "a" through "f" indicate the segments of each digit.

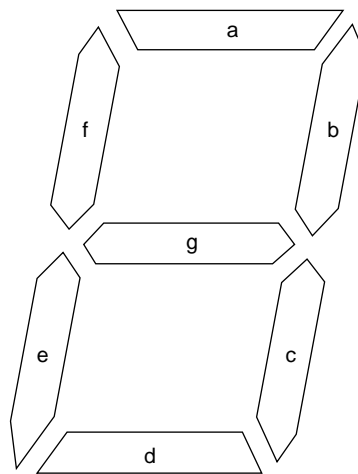
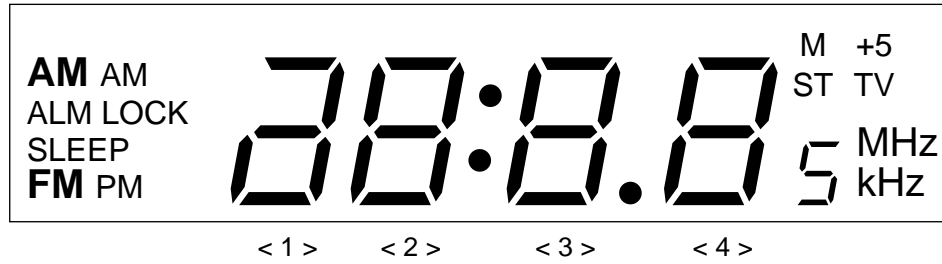

Table 3-1. Assignment of LCD Pins

Segment \ Common	COM0 (31)	COM1 (32)	COM2 (33)	COM3 (34)
LCD0 (35)	AM	ALM	SLEEP	FM
LCD1 (36)	AM	LOCK	—	PM
LCD2 (37)	—	<1>g	<1>e	<1>d
LCD3 (38)	<1>a	<1>b	<1>c	—
LCD4 (39)	<2>f	<2>g	<2>e	<2>d
LCD5 (40)	<2>a	<2>b	<2>c	:
LCD6 (41)	<3>f	<3>g	<3>e	<3>d
LCD7 (42)	<3>a	<3>b	<3>c	.
LCD8 (43)	<4>f	<4>g	<4>e	<4>d
LCD9 (44)	<4>a	<4>b	<4>c	5
LCD10 (45)	+5	TV	MHz	kHz
LCD11 (46)	M	ST	—	—
LCD12 (47)	—	—	—	—
LCD13 (48)	—	—	—	—
LCD14 (49)	—	—	—	—

Remarks 1. Numbers in brackets () are pin numbers.
 2. —: Not used

3.5 Display Description

Symbol	Description
AM	Lights when the AM band is selected in the radio mode. Lights only when a frequency is displayed.
AM	Lights when the time is in the morning in the 12-hour mode.
ALM	Lights while the alarm is set. Always lights while alarm time is set, and goes off while time is being adjusted.
FM	Lights when the FM band is selected in the radio mode. Lights only when a frequency is displayed.
kHz	Lights when a frequency is displayed or AM band is selected in the radio mode.
LOCK	Lights when key locking is valid.
M	Lights when the preset memory is manipulated in the radio mode. Also lights at 1 Hz when the preset memory is enabled to be written.
MHz	Lights when a frequency is displayed and the FM band is selected in the radio mode.
+5	Lights when +5 (preset memory shift) is valid in the radio mode.
PM	Lights when the time is in the afternoon in the 12-hour mode.
SLEEP	Lights when the sleep timer is set.
ST	Lights when the stereo input is low in the radio mode.
TV	Lights when the TV band is selected in the radio mode. Lights only when a frequency is displayed.
●	Lights when time is displayed. However, blinks at 1 Hz in synchronization with time display when the time or alarm time is adjusted.
●	
●	Lights when a frequency in the FM band is selected.
5	Lights to indicate the least significant digit of a frequency in the FM band (part). Lights if the least significant digit is 5 and goes off if it is 0.
	Displays a frequency, time, and timer. The high-order digits is zero-suppressed.

3.6 Display Example

(1) Initial display (without time set, 12-hour display)

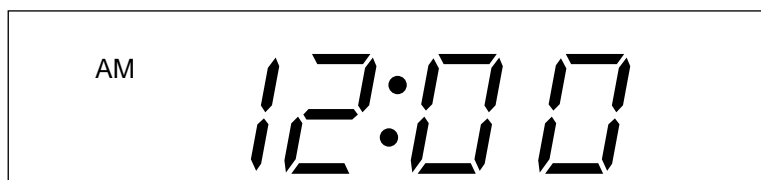

(2) Initial display (without time set, 24-hour display)

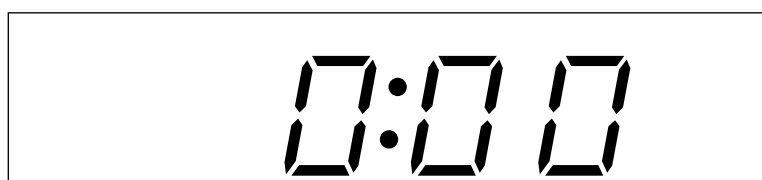

(3) Watch display (during FM band selection)

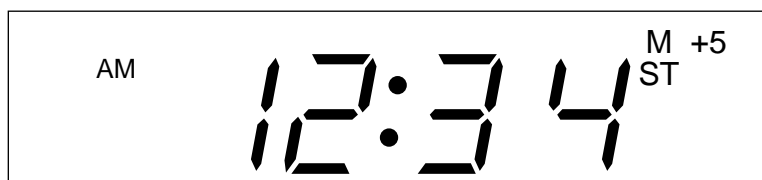

This is an example of display with "M" and "+5" lit while a stereo station is selected at 12:34 a.m.

The "FM" and "AM" indications are not displayed to avoid confusion with time when time is displayed in the radio mode.

(4) Frequency display (during FM band selection)

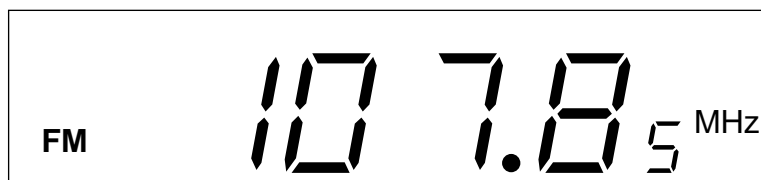

(5) Frequency display (during AM band selection)



(6) Frequency display (during TV band selection)

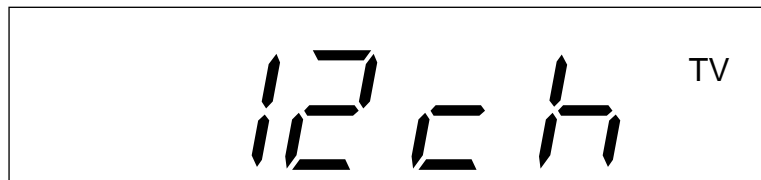

(7) Sleep timer display

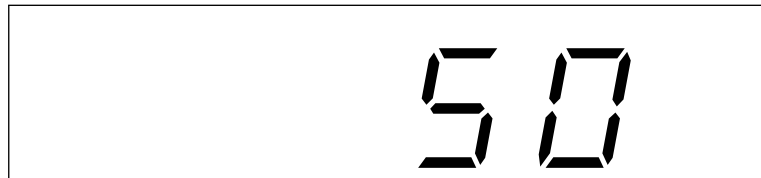

4. MUTE OUTPUT TIMING CHART

This section describes the timing of the mute output.

<1> through <7> in the timing charts indicate the time required for the respective processing, as follows:

- <1> Key ON chattering wait time
- <2> Mute leading time
- <3> Division ratio setting and display contents updating time
- <4> Mute trailing time
- <5> Scan time
- <6> PLL lock wait time
- <7> Key OFF chattering wait time

4.1 Manual up/down (operates by pressing key and releasing within 0.5 sec)

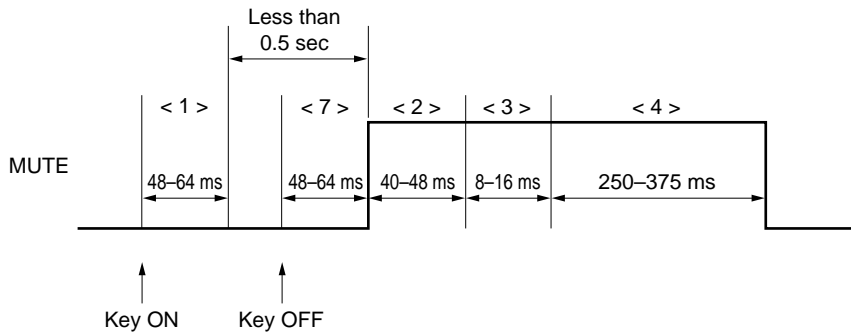

Time of <4> is 625 to 750 ms at the band edge.

4.2 Auto up/down (operates by holding down key for 0.5 sec or longer)

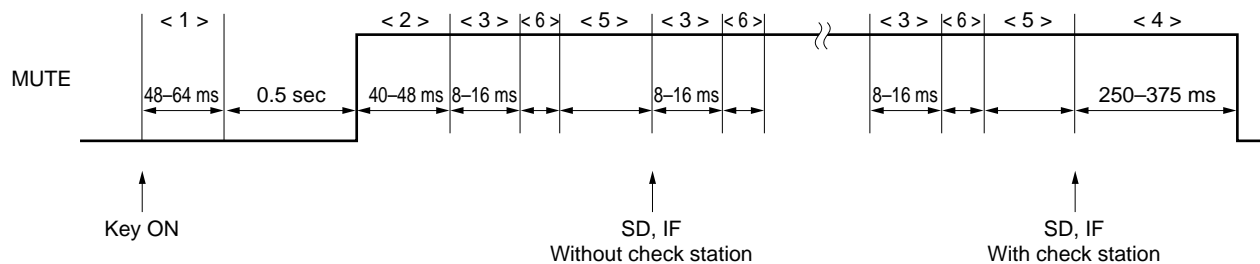

Scan time of <5> is as follows depending the received band.

FM: 40 to 48 ms

AM: 24 to 32 ms

TV: 496 to 504 ms

Time of <5> is 500 ms, and time of <4> is 625 to 750 ms at the band edge.

4.3 Calling Preset Memory

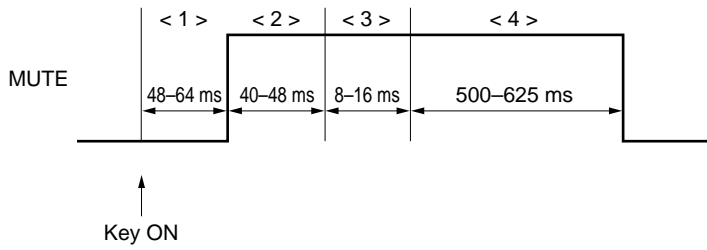

Time of <2> to <4> is the tuner mute time.

4.4 Band Selection

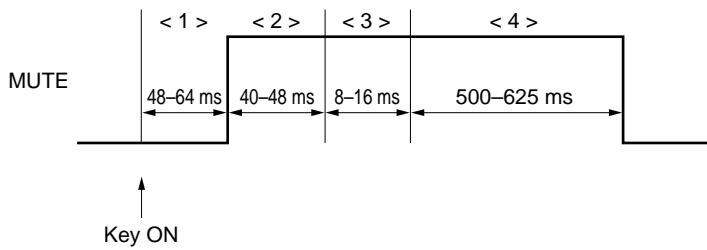

4.5 CE Pin

4.5.1 High level to low level

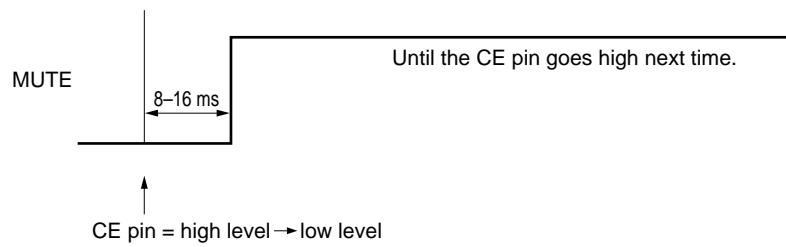

4.5.2 Low level to high level

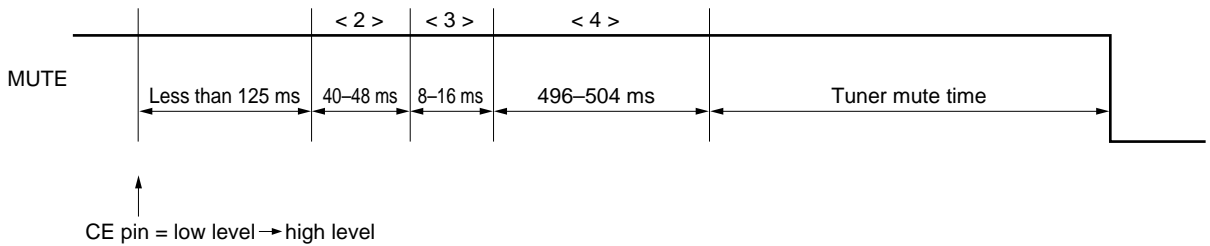

The tuner mute time is the same as 4.3 Calling Preset Memory.

4.6 Sleep Timer

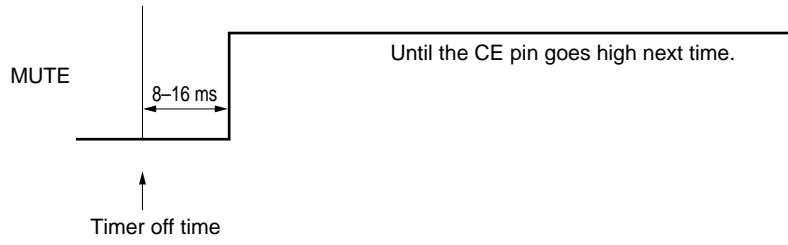

5. ELECTRICAL SPECIFICATIONS (PRELIMINARY)

Absolute Maximum Ratings (T_A = 25 °C)

Parameter	Symbol	Condition	Rating	Unit
Supply voltage	V _{DD}		-0.3 to +4.0	V
Input voltage	V _I	CE pin	-0.3 to V _{DD} +0.6	V
		Other than CE pin	-0.3 to V _{DD} +0.3	V
Output voltage	V _O		-0.3 to V _{DD} +0.3	V
High-level output current	I _{OH}	1 pin	-3.0	mA
		Total of all pins	-20.0	mA
Low-level output current	I _{OL}	1 pin	3.0	mA
		Total of all pins	20.0	mA
Operating temperature	T _A		-20 to +70	°C
Storage temperature	T _{stg}		-55 to +125	°C

Caution If any of the parameters exceeds the absolute maximum ratings, even momentarily, the quality of the product may be impaired. The absolute maximum ratings are values that may physically damage the product(s). Be sure to use the product(s) within the ratings.

Recommended Operating Range

Parameter	Symbol	Condition	MIN.	TYP.	MAX.	Unit
Supply voltage	V _{DD1}	When CPU, PLL, and AD operates	1.8	3.0	3.6	V
		T _A = -20 to +70 °C				
	V _{DD2}	When CPU operates, and PLL and AD stop	T _A = -10 to +70 °C	1.7	3.0	3.6
T _A = 0 to +70 °C			1.6	3.0	3.6	V
Supply voltage rise time	t _{RISE}	V _{DD} = 0 → 1.8 V (T _A = 25 °C)			500	ms

DC Characteristics (T_A = -20 to +70 °C, V_{DD} = 1.8 to 3.6 V)

(1/2)

Parameter	Symbol	Condition	MIN.	TYP.	MAX.	Unit
Supply current	I _{DD1}	When CPU and PLL are operating with sine wave input to VCOH pin (f _{IN} = 250 MHz, V _{IN} = 0.2 Vp-p) V _{DD} = 3 V, T _A = 25 °C		6.5	10	mA
	I _{DD2}	When CPU is operating and PLL is stopped (IF counter stops) with sine wave input to X _{IN} pin (f _{IN} = 75 kHz, V _{IN} = V _{DD}) V _{DD} = 3 V, T _A = 25 °C		35	45	μA
	I _{DD3}	When CPU and PLL are stopped (when HALT instruction is used) with sine wave input to X _{IN} pin (f _{IN} = 75 kHz, V _{IN} = V _{DD}) V _{DD} = 3 V, T _A = 25 °C		10	18	μA
Data retention voltage	V _{DDR}	On detection of power failure	1.7			V
Data retention current	I _{DDR}	When crystal oscillator stops V _{DD} = 3.0 V, T _A = 25 °C			3	μA
High-level input voltage	V _{IH1}	CE, INT, P0B0-P0B3, P0C0, P0C1, P0D2, P0D3	0.8 V _{DD}			V
	V _{IH2}	P1A0-P1A3	0.5 V _{DD}			V
Low-level input voltage	V _{IL1}	CE, INT, P0B0-P0B3, P0C0, P0C1, P0D2, P0D3			0.2 V _{DD}	V
	V _{IL2}	P1A0-P1A3			0.05 V _{DD}	V
High-level output current	I _{OH1}	P0A0-P0A3, P0B0-P0B3, P0C0, P0C1, P0D2, P0D3, P1B0-P1B3, P1C0, BEEP V _{OH} = V _{DD} - 0.5 V	-0.5			mA
	I _{OH2}	EO V _{OH} = V _{DD} - 0.5 V	-0.2			mA
	I _{OH3}	LCD0-LCD14 V _{OH} = V _{DD} - 0.5 V	-20			μA
Low-level output current	I _{OL1}	P0A0-P0A3, P0B0-P0B3, P0C0, P0C1, P0D2, P0D3, P1C0, BEEP V _{OL} = 0.5 V	0.5			mA
	I _{OL2}	EO V _{OL} = 0.5 V	0.2			mA
	I _{OL3}	P1B0-P1B3 V _{OL} = 0.5 V	5			μA
	I _{OL4}	LCD0-LCD14 V _{OL} = 0.5 V	20			μA
High-level input current	I _{IH1}	When P1A0 through P1A3 are pulled down V _{IH} = V _{DD} = 1.8 V	3		30	μA
	I _{IH2}	When X _{IN} pin is pulled down V _{IH} = V _{DD} = 1.8 V	40			μA
LCD drive voltage	V _{LCD1}	When LCD0 through LCD14 outputs are open C1 = 0.1 μF, C2 = 0.01 μF T _A = 25 °C	2.8	3.1	3.3	V
Output off leakage current	I _L	EO			±1	μA

AC Characteristics (T_A = -20 to +70 °C, V_{DD} = 1.8 to 3.6 V)

(2/2)

Parameter	Symbol	Condition	MIN.	TYP.	MAX.	Unit
Operating frequency	f _{IN1}	VCOL pin, MF mode, with sine wave input V _{IN} = 0.2 V _{p-p}	0.3		8	MHz
	f _{IN2}	VCOL pin, HF mode, with sine wave input V _{IN} = 0.3 V _{p-p}	5		130	MHz
	f _{IN3}	VCOH pin, VHF mode, with sine wave input V _{IN} = 0.2 V _{p-p}	40		230	MHz
	f _{IN4}	FMIFC/AMIFC pin, AMIF count mode, with sine wave input V _{IN} = 0.1 V _{p-p}	400		500	kHz
	f _{IN5}	FMIFC/AMIFC pin, AMIF count mode, with sine wave input V _{IN} = 0.15 V _{p-p}	0.4		2	MHz
	f _{IN6}	FMIFC/AMIFC pin, FMIF count mode, with sine wave input V _{IN} = 0.1 V _{p-p}	10		11	MHz

A/D Converter Characteristics (T_A = -20 to +70 °C, V_{DD} = 1.8 to 3.6 V)

Parameter	Symbol	Condition	MIN.	TYP.	MAX.	Unit
A/D conversion resolution					4	bit
A/D conversion total error		T _A = 25 °C			±1.5	LSB

6. PACKAGE

56 PIN PLASTIC QFP (10×10)

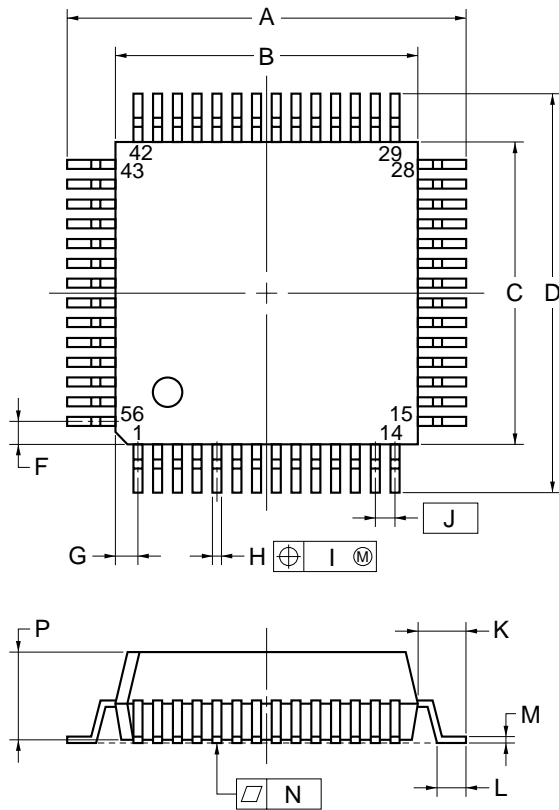

detail of lead end

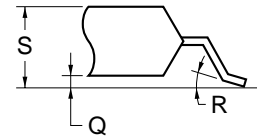

NOTE

Each lead centerline is located within 0.13 mm (0.005 inch) of its true position (T.P.) at maximum material condition.

ITEM	MILLIMETERS	INCHES
A	12.8±0.4	0.504±0.016
B	10.0±0.2	0.394±0.008
C	10.0±0.2	0.394±0.008
D	12.8±0.4	0.504±0.016
F	0.8	0.031
G	0.8	0.031
H	0.30±0.10	0.012±0.004
I	0.13	0.005
J	0.65 (T.P.)	0.026 (T.P.)
K	1.4±0.2	0.055±0.008
L	0.6±0.2	0.024 ^{+0.008} _{-0.009}
M	0.15 ^{+0.10} _{-0.05}	0.006 ^{+0.004} _{-0.003}
N	0.10	0.004
P	1.7	0.067
Q	0.125±0.075	0.005±0.003
R	5°±5°	5°±5°
S	2.0 MAX.	0.079 MAX.

S56GB-65-1A7-3

[MEMO]

[MEMO]

[MEMO]

NOTES FOR CMOS DEVICES

① PRECAUTION AGAINST ESD FOR SEMICONDUCTORS

Note: Strong electric field, when exposed to a MOS device, can cause destruction of the gate oxide and ultimately degrade the device operation. Steps must be taken to stop generation of static electricity as much as possible, and quickly dissipate it once, when it has occurred. Environmental control must be adequate. When it is dry, humidifier should be used. It is recommended to avoid using insulators that easily build static electricity. Semiconductor devices must be stored and transported in an anti-static container, static shielding bag or conductive material. All test and measurement tools including work bench and floor should be grounded. The operator should be grounded using wrist strap. Semiconductor devices must not be touched with bare hands. Similar precautions need to be taken for PW boards with semiconductor devices on it.

② HANDLING OF UNUSED INPUT PINS FOR CMOS

Note: No connection for CMOS device inputs can be cause of malfunction. If no connection is provided to the input pins, it is possible that an internal input level may be generated due to noise, etc., hence causing malfunction. CMOS device behave differently than Bipolar or NMOS devices. Input levels of CMOS devices must be fixed high or low by using a pull-up or pull-down circuitry. Each unused pin should be connected to V_{DD} or GND with a resistor, if it is considered to have a possibility of being an output pin. All handling related to the unused pins must be judged device by device and related specifications governing the devices.

③ STATUS BEFORE INITIALIZATION OF MOS DEVICES

Note: Power-on does not necessarily define initial status of MOS device. Production process of MOS does not define the initial operation status of the device. Immediately after the power source is turned ON, the devices with reset function have not yet been initialized. Hence, power-on does not guarantee out-pin levels, I/O settings or contents of registers. Device is not initialized until the reset signal is received. Reset operation must be executed immediately after power-on for devices having reset function.

Regional Information

Some information contained in this document may vary from country to country. Before using any NEC product in your application, please contact the NEC office in your country to obtain a list of authorized representatives and distributors. They will verify:

- Device availability
- Ordering information
- Product release schedule
- Availability of related technical literature
- Development environment specifications (for example, specifications for third-party tools and components, host computers, power plugs, AC supply voltages, and so forth)
- Network requirements

In addition, trademarks, registered trademarks, export restrictions, and other legal issues may also vary from country to country.

NEC Electronics Inc. (U.S.)

Santa Clara, California
Tel: 800-366-9782
Fax: 800-729-9288

NEC Electronics (Germany) GmbH

Duesseldorf, Germany
Tel: 0211-65 03 02
Fax: 0211-65 03 490

NEC Electronics (UK) Ltd.

Milton Keynes, UK
Tel: 01908-691-133
Fax: 01908-670-290

NEC Electronics Italiana s.r.l.

Milano, Italy
Tel: 02-66 75 41
Fax: 02-66 75 42 99

NEC Electronics (Germany) GmbH

Benelux Office
Eindhoven, The Netherlands
Tel: 040-2445845
Fax: 040-2444580

NEC Electronics (France) S.A.

Velizy-Villacoublay, France
Tel: 01-30-67 58 00
Fax: 01-30-67 58 99

NEC Electronics (France) S.A.

Spain Office
Madrid, Spain
Tel: 01-504-2787
Fax: 01-504-2860

NEC Electronics (Germany) GmbH

Scandinavia Office
Taeby, Sweden
Tel: 08-63 80 820
Fax: 08-63 80 388

NEC Electronics Hong Kong Ltd.

Hong Kong
Tel: 2886-9318
Fax: 2886-9022/9044

NEC Electronics Hong Kong Ltd.

Seoul Branch
Seoul, Korea
Tel: 02-528-0303
Fax: 02-528-4411

NEC Electronics Singapore Pte. Ltd.

United Square, Singapore 1130
Tel: 253-8311
Fax: 250-3583

NEC Electronics Taiwan Ltd.

Taipei, Taiwan
Tel: 02-719-2377
Fax: 02-719-5951

NEC do Brasil S.A.

Sao Paulo-SP, Brasil
Tel: 011-889-1680
Fax: 011-889-1689

[MEMO]

Purchase of NEC I²C components conveys a license under the Philips I²C Patent Rights to use these components in an I²C system, provided that the system conforms to the I²C Standard Specification as defined by Philips.

No part of this document may be copied or reproduced in any form or by any means without the prior written consent of NEC Corporation. NEC Corporation assumes no responsibility for any errors which may appear in this document.

NEC Corporation does not assume any liability for infringement of patents, copyrights or other intellectual property rights of third parties by or arising from use of a device described herein or any other liability arising from use of such device. No license, either express, implied or otherwise, is granted under any patents, copyrights or other intellectual property rights of NEC Corporation or others.

While NEC Corporation has been making continuous effort to enhance the reliability of its semiconductor devices, the possibility of defects cannot be eliminated entirely. To minimize risks of damage or injury to persons or property arising from a defect in an NEC semiconductor device, customers must incorporate sufficient safety measures in its design, such as redundancy, fire-containment, and anti-failure features.

NEC devices are classified into the following three quality grades:

"Standard", "Special", and "Specific". The Specific quality grade applies only to devices developed based on a customer designated "quality assurance program" for a specific application. The recommended applications of a device depend on its quality grade, as indicated below. Customers must check the quality grade of each device before using it in a particular application.

Standard: Computers, office equipment, communications equipment, test and measurement equipment, audio and visual equipment, home electronic appliances, machine tools, personal electronic equipment and industrial robots

Special: Transportation equipment (automobiles, trains, ships, etc.), traffic control systems, anti-disaster systems, anti-crime systems, safety equipment and medical equipment (not specifically designed for life support)

Specific: Aircrafts, aerospace equipment, submersible repeaters, nuclear reactor control systems, life support systems or medical equipment for life support, etc.

The quality grade of NEC devices is "Standard" unless otherwise specified in NEC's Data Sheets or Data Books. If customers intend to use NEC devices for applications other than those specified for Standard quality grade, they should contact an NEC sales representative in advance.

Anti-radioactive design is not implemented in this product.