

# ASSP for Image Processing

CMOS

## A/D Converter (1-channel, 8-bit, 45MHz)

### MB40C558

#### DESCRIPTION

The MB40C558 is a high-speed A/D converter using high-speed CMOS process technology.

#### FEATURES

- Resolution: 8 bits
- Linearity error:  $\pm 0.20\%$  (Typ.)
- Maximum conversion rate: 45 MSPS (Min.)
- Power supply voltage: Analog section +5.0 V  
Digital section +3.0 V or +5.0 V
- Digital input voltage range: TTL level
- Digital output voltage range: CMOS level compatible
- Analog input voltage range: 0.5 to 3 V (with 2 V<sub>p-p</sub>)
- Analog input capacity: 15 pF (Typ.)
- Power consumption: 110 mW (Typical: @f<sub>CLK</sub> = 45 MHz, AV<sub>DD</sub> = 5 V, DV<sub>DD</sub> = 3 V)  
135 mW (Typical: @f<sub>CLK</sub> = 45 MHz, AV<sub>DD</sub> = 5 V, DV<sub>DD</sub> = 3 V)
- Additional function: Reference voltage generator circuit: V<sub>REFT</sub> = 3 V, V<sub>REFB</sub> = 1 V
- Package options: SOP24, SSOP24

#### PACKAGES

24-pin, Plastic SOP

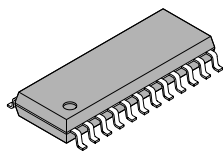

(FPT-24P-M01)

24-pin, Plastic SSOP

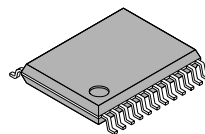

(FPT-24P-M03)

This device contains circuitry to protect the inputs against damage due to high static voltages or electric fields. However, it is advised that normal precautions be taken to avoid application of any voltage higher than maximum rated voltages to this high impedance circuit.

## ■ PIN ASSIGNMENT

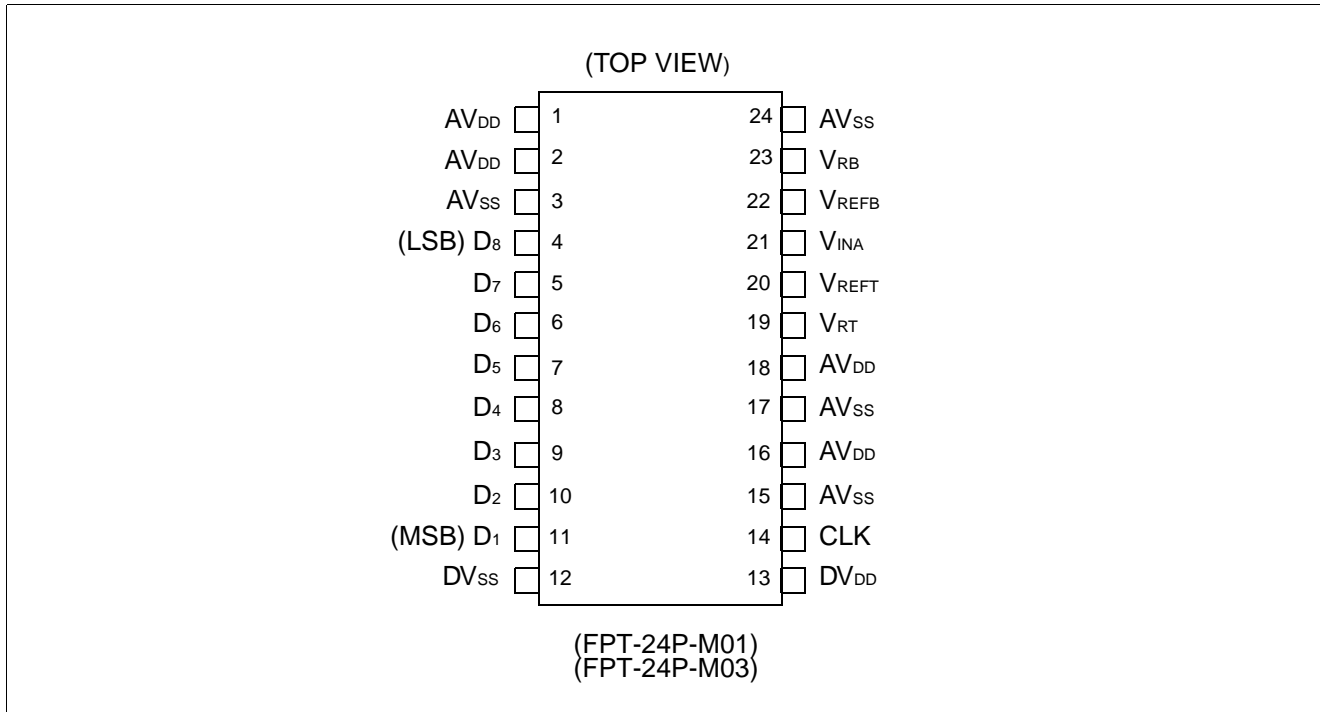

## ■ PIN DESCRIPTION

Pin No.	Pin name	Functions
1, 2, 16, 18	AV <sub>DD</sub>	Analog power supply pins (+5 V)
13	DV <sub>DD</sub>	Digital power supply pin (+3 or +5 V)
3, 15, 17, 24	AV <sub>SS</sub>	Analog power ground pins (0 V)
12	DV <sub>SS</sub>	Digital power ground pin (0 V)
4 to 11	D <sub>1</sub> to D <sub>8</sub>	Digital output pins. D <sub>1</sub> : MSB, D <sub>8</sub> : LSB
14	CLK	Clock input pin
21	V <sub>INA</sub>	Analog input pin. Input range: V <sub>RB</sub> to V <sub>RT</sub> (2 V <sub>p-p</sub> between 0.5 to 3 V)
19	V <sub>RT</sub>	Reference voltage input pin (3 V)
20	V <sub>REFT</sub>	Reference voltage output pin. When connected to V <sub>RT</sub> , the pin generates 0.6 × AV <sub>DD</sub> (3 V).
23	V <sub>RB</sub>	Reference voltage input pin (1 V)
22	V <sub>REFB</sub>	Reference voltage output pin. When connected to V <sub>RB</sub> , the pin generates 0.2 × AV <sub>DD</sub> (1 V).

Values within ( ) are typical values.

## ■ NOTES ON USE

- Be sure to bypass the AV<sub>DD</sub>, DV<sub>DD</sub>, V<sub>RT</sub> and V<sub>RB</sub> pins to the ground using a high-frequency capacitor. The high-frequency capacitor should be connected as near the pin as possible.
- Provide four clocks or more immediately after the power up to prevent current dissipation due to the indeterminate internal logic.

## ■ ABSOLUTE MAXIMUM RATINGS (See WARNING)

Parameter	Symbol	Rating		Unit
		Min.	Max.	
Power supply voltage	$AV_{DD}, DV_{DD}$	-0.3	7.0	V
Input voltage	CLK, $V_{INA}$ $V_{RT}, V_{RB}$	-0.3	$AV_{DD}+0.3$	V
Output voltage	$D_1$ to $D_8$	-0.3	$DV_{DD}+0.3$	V
Storage temperature	Tstg	-55	+125	°C

**WARNING:** Semiconductor devices can be permanently damaged by application of stress (voltage, current, temperature, etc.) in excess of absolute maximum ratings. Do not exceed these ratings.

## ■ RECOMMENDED OPERATING CONDITIONS

Parameter	Symbol	Value			Unit
		Min.	Typ.	Max.	
Analog input voltage	$V_{INA}$	$V_{RB}$	–	$V_{RT}$	V
Analog reference voltage: T	$V_{RT}$	–	–	3.00	V
Analog reference voltage: B	$V_{RB}$	0.50	–	–	V
Analog reference voltage range	$V_{RT}-V_{RB}$	1.90	2.00	2.10	V
Digital "H" level input voltage	$V_{IHD}$	2.4	–	–	V
Digital "L" level input voltage	$V_{ILD}$	–	–	0.8	V
Digital input current	$I_{ID}$	–	–	5	μA
Clock frequency	$f_{CLK}$	0.1	–	45	MHz
Minimum "H" level clock pulse width	$tw^+$	10.0	–	–	ns
Minimum "L" level clock pulse width	$tw^-$	10.0	–	–	ns
Operating temperature range	$T_a$	-20	–	70	°C

**WARNING:** Recommended operating conditions are normal operating ranges for the semiconductor device. All the device's electrical characteristics are warranted when operated within these ranges.

Always use semiconductor devices within the recommended operating conditions. Operation outside these ranges may adversely affect reliability and could result in device failure.

No warranty is made with respect to uses, operating conditions, or combinations not represented on the data sheet. Users considering application outside the listed conditions are advised to contact their FUJITSU representative beforehand.

(Continued)

# MB40C558

(Continued)

- When using a single power supply

Parameter	Symbol	Value			Unit
		Min.	Typ.	Max.	
Power supply voltage	$AV_{DD}, DV_{DD}$	4.75	5.00	5.25	V

- When using dual power supplies

Parameter	Symbol	Value			Unit
		Min.	Typ.	Max.	
Power supply voltage	$AV_{DD}$	4.75	5.00	5.25	V
	$DV_{DD}$	2.70	3.00	3.30	V

**WARNING:** Recommended operating conditions are normal operating ranges for the semiconductor device. All the device's electrical characteristics are warranted when operated within these ranges.

Always use semiconductor devices within the recommended operating conditions. Operation outside these ranges may adversely affect reliability and could result in device failure.

No warranty is made with respect to uses, operating conditions, or combinations not represented on the data sheet. Users considering application outside the listed conditions are advised to contact their FUJITSU representative beforehand.

## ■ ELECTRICAL CHARACTERISTICS (Using a Single Power Supply)

### DC Characteristics

#### (1) Analog section

( $AV_{DD} = DV_{DD} = 4.75\text{ V to }+5.25\text{ V}$ ,  $T_a = -20^\circ\text{C to }+70^\circ\text{C}$ )

Parameter	Symbol	Value			Unit	
		Min.	Typ.	Max.		
Resolution	–	–	8	–	bit	
Linearity error	DC precision	LE	–	$\pm 0.20$	$\pm 0.30$	%
Differential linearity error		DLE	–	$\pm 0.12$	$\pm 0.20$	%
Analog input capacity	$C_{INA}$	–	15	–	pF	
Reference voltage: T	$V_{REFT}$	–	$0.6 \times AV_{DD}$	–	V	
Reference voltage: B	$V_{REFB}$	–	$0.2 \times AV_{DD}$	–	V	
Reference current	$I_{RB}$	–16.0	–8.0	–2.0	mA	
Analog power supply current	$AI_{DD}$	–	18.0	31.0	mA	
Digital power supply current	$DI_{DD}$	–	9.0	15.0	mA	

#### (2) Digital section

( $AV_{DD} = DV_{DD} = 4.75\text{ V to }+5.25\text{ V}$ ,  $T_a = -20^\circ\text{C to }+70^\circ\text{C}$ )

Parameter	Symbol	Value			Unit
		Min.	Typ.	Max.	
Digital “H” level output voltage	$V_{OHD}$	4.2	–	$DV_{DD}$	V
Digital “L” level output voltage	$V_{OLD}$	–	–	0.4	V
Digital “H” level output current	$I_{OH}$	–400	–	–	$\mu\text{A}$
Digital “L” level output current	$I_{OL}$	–	–	1.6	mA

#### (3) Switching section

( $AV_{DD} = DV_{DD} = 4.75\text{ V to }+5.25\text{ V}$ ,  $T_a = -20^\circ\text{C to }+70^\circ\text{C}$ )

Parameter	Symbol	Value			Unit
		Min.	Typ.	Max.	
Maximum conversion rate	fs	45	–	–	MSPS
Digital output delay time	tpd	0	5	14	ns

# MB40C558

## ■ ELECTRICAL CHARACTERISTICS (Using Dual Power Supplies)

### DC Characteristics

#### (1) Analog section

( $AV_{DD} = 4.75\text{ V to }+5.25\text{ V}$ ,  $DV_{DD} = 2.70\text{ V to }+3.30\text{ V}$   $T_a = -20^\circ\text{C to }+70^\circ\text{C}$ )

Parameter	Symbol	Value			Unit	
		Min.	Typ.	Max.		
Resolution	–	–	8	–	bit	
Linearity error	DC precision	LE	–	$\pm 0.20$	$\pm 0.30$	%
Differential linearity error		DLE	–	$\pm 0.12$	$\pm 0.20$	%
Analog input capacity	$C_{INA}$	–	15	–	pF	
Reference voltage: T	$V_{REFT}$	–	$0.6 \times AV_{DD}$	–	V	
Reference voltage: B	$V_{REFB}$	–	$0.2 \times AV_{DD}$	–	V	
Reference current	$I_{RB}$	–16.0	–8.0	–2.0	mA	
Analog power supply current	$AI_{DD}$	–	18.0	31.0	mA	
Digital power supply current	$DI_{DD}$	–	6.0	10.0	mA	

#### (2) Digital section

( $AV_{DD} = 4.75\text{ V to }+5.25\text{ V}$ ,  $DV_{DD} = 2.70\text{ V to }+3.30\text{ V}$   $T_a = -20^\circ\text{C to }+70^\circ\text{C}$ )

Parameter	Symbol	Value			Unit
		Min.	Typ.	Max.	
Digital "H" level output voltage	$V_{OHD}$	2.4	–	$DV_{DD}$	V
Digital "L" level output voltage	$V_{OLD}$	–	–	0.4	V
Digital "H" level output current	$I_{OH}$	–400	–	–	$\mu\text{A}$
Digital "L" level output current	$I_{OL}$	–	–	1.6	mA

#### (3) Switching section

( $AV_{DD} = 4.75\text{ V to }+5.25\text{ V}$ ,  $DV_{DD} = 2.70\text{ V to }+3.30\text{ V}$   $T_a = -20^\circ\text{C to }+70^\circ\text{C}$ )

Parameter	Symbol	Value			Unit
		Min.	Typ.	Max.	
Maximum conversion rate	fs	45	–	–	MSPS
Digital output delay time	tpd	0	6	15	ns

## ■ EQUIVALENT CIRCUIT

### • Clock input

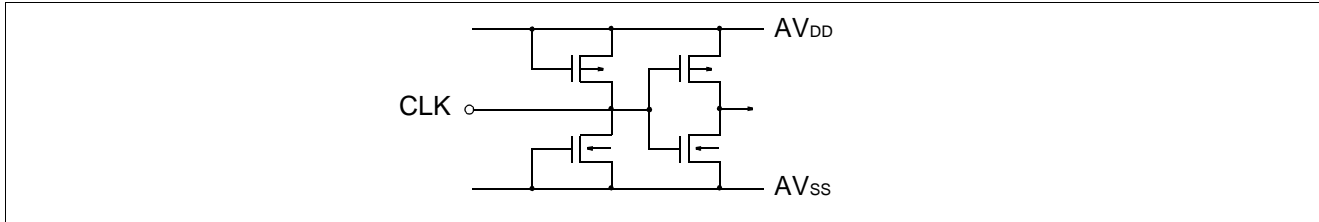

### • Analog input

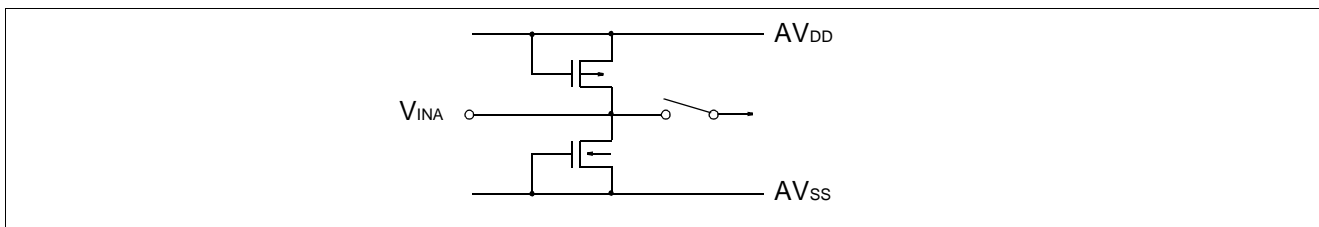

### • Reference voltage input

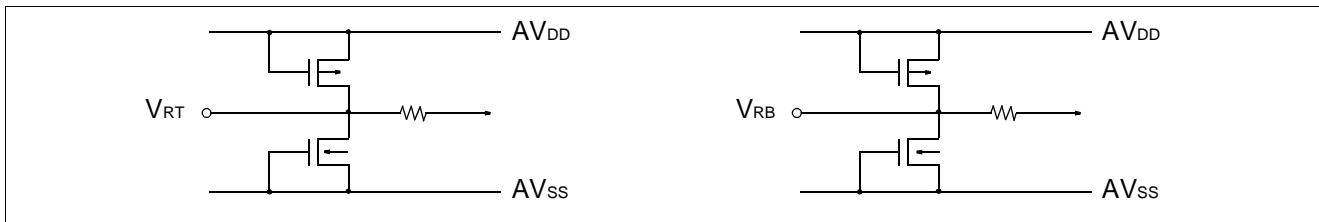

### • Reference voltage output

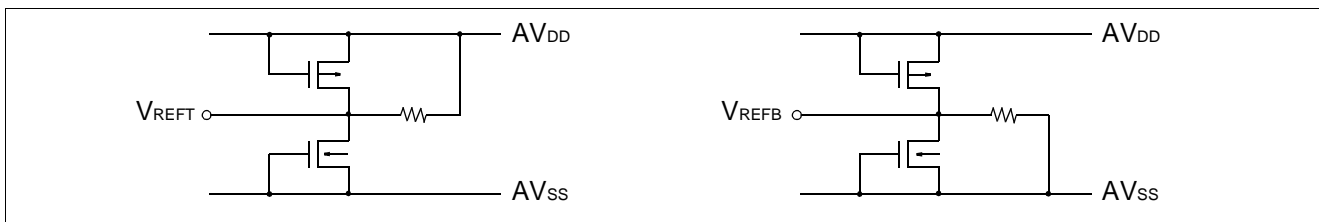

### • Digital output

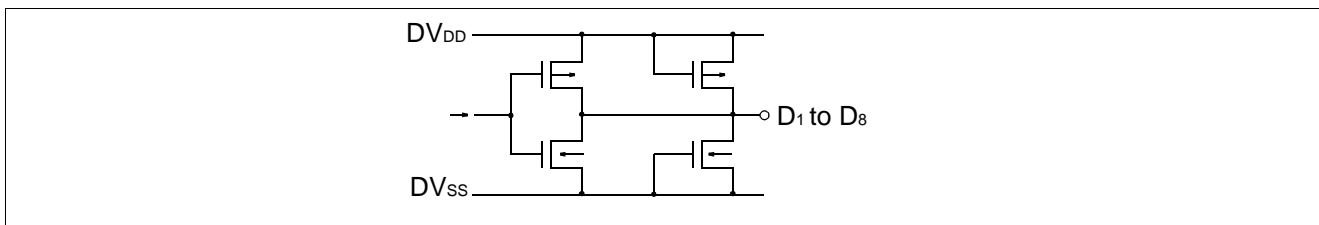

## ■ TIMING CHART

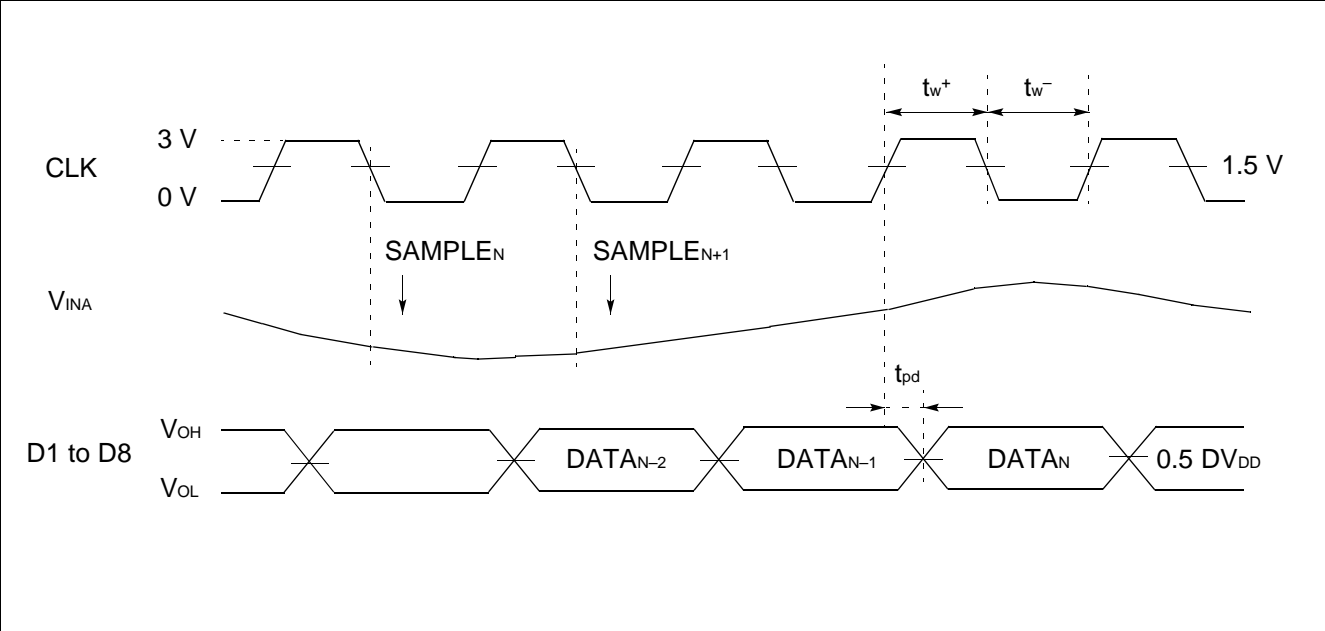

## ■ DIGITAL OUTPUT BUFFER LOAD CIRCUIT

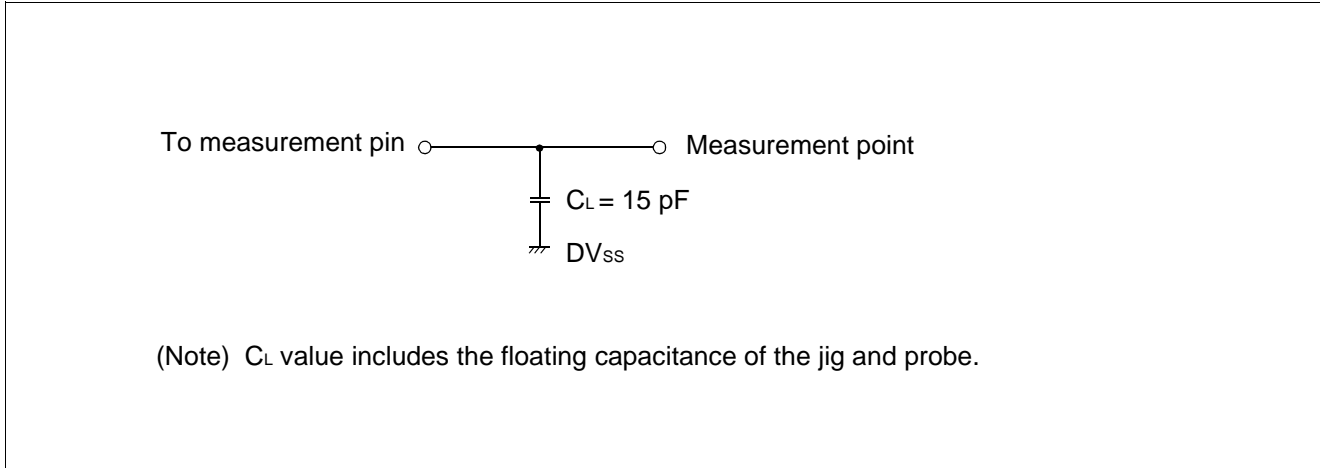



## ■ ORDERING INFORMATION

Part number	Package	Remarks
MB40C558PF	24-pin, Plastic SOP (FPT-24P-M01)	
MB40C558PFV	24-pin, Plastic SSOP (FPT-24P-M03)	

# MB40C558

## ■ PACKAGE DIMENSIONS

24-pin, Plastic SOP  
(FPT-24P-M01)

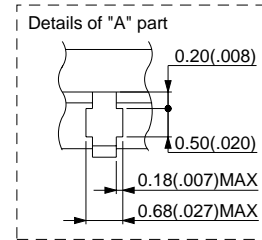
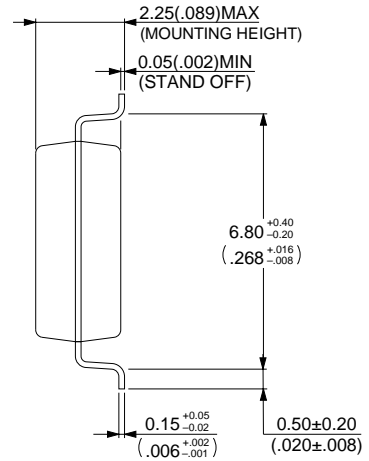
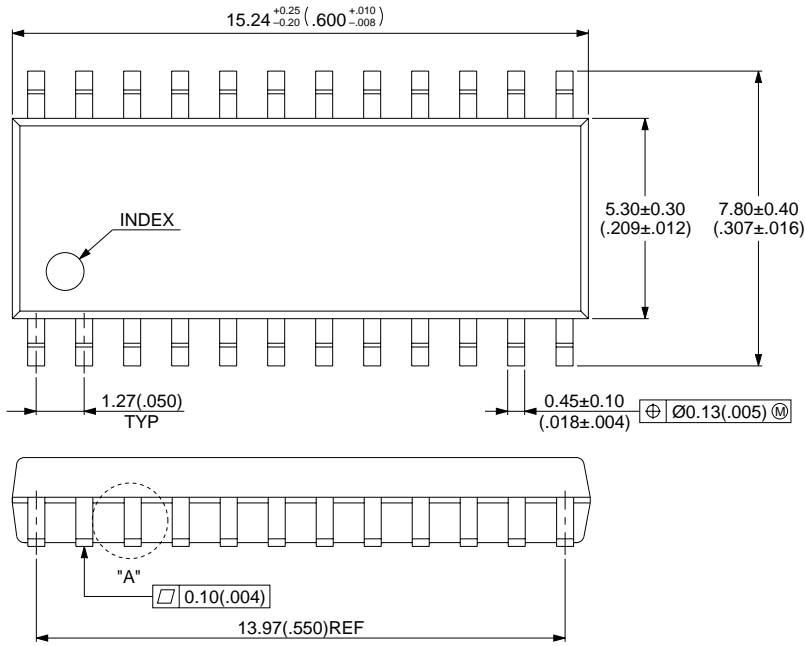

© 1994 FUJITSU LIMITED F24007S-3C-4

Dimensions in mm (inches).

(Continued)

(Continued)

24-pin, Plastic SSOP  
(FPT-24P-M03)

\*: These dimensions do not include resin protrusion.

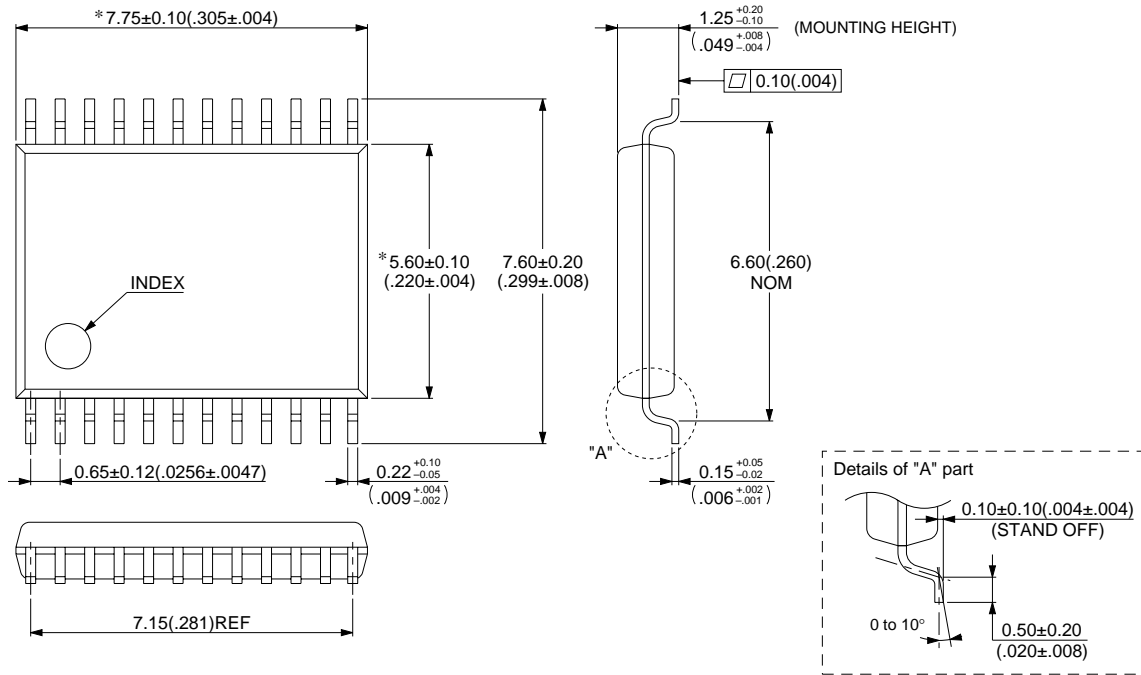

© 1994 FUJITSU LIMITED F24018S-2C-2

Dimensions in mm (inches).

## FUJITSU LIMITED

*For further information please contact:*

### **Japan**

FUJITSU LIMITED  
Corporate Global Business Support Division  
Electronic Devices  
KAWASAKI PLANT, 4-1-1, Kamikodanaka  
Nakahara-ku, Kawasaki-shi  
Kanagawa 211-88, Japan  
Tel: (044) 754-3763  
Fax: (044) 754-3329

### **North and South America**

FUJITSU MICROELECTRONICS, INC.  
Semiconductor Division  
3545 North First Street  
San Jose, CA 95134-1804, U.S.A.  
Tel: (408) 922-9000  
Fax: (408) 432-9044/9045

### **Europe**

FUJITSU MIKROELEKTRONIK GmbH  
Am Siebenstein 6-10  
63303 Dreieich-Buchsschlag  
Germany  
Tel: (06103) 690-0  
Fax: (06103) 690-122

### **Asia Pacific**

FUJITSU MICROELECTRONICS ASIA PTE. LIMITED  
#05-08, 151 Lorong Chuan  
New Tech Park  
Singapore 556741  
Tel: (65) 281-0770  
Fax: (65) 281-0220

F9703

© FUJITSU LIMITED Printed in Japan

All Rights Reserved.

The contents of this document are subject to change without notice. Customers are advised to consult with FUJITSU sales representatives before ordering.

The information and circuit diagrams in this document presented as examples of semiconductor device applications, and are not intended to be incorporated in devices for actual use. Also, FUJITSU is unable to assume responsibility for infringement of any patent rights or other rights of third parties arising from the use of this information or circuit diagrams.

FUJITSU semiconductor devices are intended for use in standard applications (computers, office automation and other office equipment, industrial, communications, and measurement equipment, personal or household devices, etc.).

#### **CAUTION:**

Customers considering the use of our products in special applications where failure or abnormal operation may directly affect human lives or cause physical injury or property damage, or where extremely high levels of reliability are demanded (such as aerospace systems, atomic energy controls, sea floor repeaters, vehicle operating controls, medical devices for life support, etc.) are requested to consult with FUJITSU sales representatives before such use. The company will not be responsible for damages arising from such use without prior approval.

Any semiconductor devices have inherently a certain rate of failure. You must protect against injury, damage or loss from such failures by incorporating safety design measures into your facility and equipment such as redundancy, fire protection, and prevention of over-current levels and other abnormal operating conditions.

If any products described in this document represent goods or technologies subject to certain restrictions on export under the Foreign Exchange and Foreign Trade Control Law of Japan, the prior authorization by Japanese government should be required for export of those products from Japan.

\*DS04-2821