

# TIPL791, TIPL791A NPN SILICON POWER TRANSISTORS

Copyright © 1997, Power Innovations Limited, UK

MAY 1989 - REVISED MARCH 1997

- Rugged Triple-Diffused Planar Construction
- 4 A Continuous Collector Current
- Operating Characteristics Fully Guaranteed at 100°C
- 1000 Volt Blocking Capability

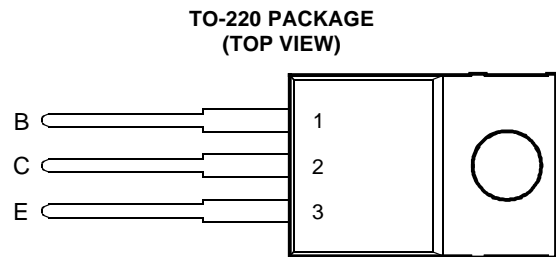

Pin 2 is in electrical contact with the mounting base.

MDTRACA

## absolute maximum ratings at 25°C case temperature (unless otherwise noted)

RATING		SYMBOL	VALUE	UNIT
Collector-base voltage ( $I_E = 0$ )	TIPL791	$V_{CBO}$	850	V
	TIPL791A		1000	
Collector-emitter voltage ( $V_{BE} = 0$ )	TIPL791	$V_{CES}$	850	V
	TIPL791A		1000	
Collector-emitter voltage ( $I_B = 0$ )	TIPL791	$V_{CEO}$	400	V
	TIPL791A		450	
Emitter-base voltage		$V_{EBO}$	10	V
Continuous collector current		$I_C$	4	A
Peak collector current (see Note 1)		$I_{CM}$	8	A
Continuous device dissipation at (or below) 25°C case temperature		$P_{tot}$	75	W
Operating junction temperature range		$T_j$	-65 to +150	°C
Storage temperature range		$T_{stg}$	-65 to +150	°C

NOTE 1: This value applies for  $t_p \leq 10$  ms, duty cycle  $\leq 2\%$ .

## PRODUCT INFORMATION

Information is current as of publication date. Products conform to specifications in accordance with the terms of Power Innovations standard warranty. Production processing does not necessarily include testing of all parameters.

# TIPL791, TIPL791A

## NPN SILICON POWER TRANSISTORS

MAY 1989 - REVISED MARCH 1997

### electrical characteristics at 25°C case temperature (unless otherwise noted)

PARAMETER	TEST CONDITIONS			MIN	TYP	MAX	UNIT
$V_{CEO(sus)}$ Collector-emitter sustaining voltage	$I_C = 100 \text{ mA}$	$L = 25 \text{ mH}$	(see Note 2)	TIPL791 400 TIPL791A 450			V
$I_{CES}$ Collector-emitter cut-off current	$V_{CE} = 850 \text{ V}$ $V_{CE} = 1000 \text{ V}$ $V_{CE} = 850 \text{ V}$ $V_{CE} = 1000 \text{ V}$	$V_{BE} = 0$ $V_{BE} = 0$ $V_{BE} = 0$ $V_{BE} = 0$	$T_C = 100^\circ\text{C}$ $T_C = 100^\circ\text{C}$	TIPL791 TIPL791A TIPL791 TIPL791A		5 5 200 200	$\mu\text{A}$
$I_{CEO}$ Collector cut-off current	$V_{CE} = 400 \text{ V}$ $V_{CE} = 450 \text{ V}$	$I_B = 0$ $I_B = 0$		TIPL791 TIPL791A		5 5	$\mu\text{A}$
$I_{EBO}$ Emitter cut-off current	$V_{EB} = 10 \text{ V}$	$I_C = 0$				1	mA
$h_{FE}$ Forward current transfer ratio	$V_{CE} = 5 \text{ V}$	$I_C = 0.5 \text{ A}$	(see Notes 3 and 4)	20		60	
$V_{CE(sat)}$ Collector-emitter saturation voltage	$I_B = 0.2 \text{ A}$ $I_B = 0.5 \text{ A}$ $I_B = 1 \text{ A}$ $I_B = 1 \text{ A}$	$I_C = 1 \text{ A}$ $I_C = 2.5 \text{ A}$ $I_C = 4 \text{ A}$ $I_C = 4 \text{ A}$	$T_C = 100^\circ\text{C}$ (see Notes 3 and 4)			0.5 1.0 2.5 5.0	V
$V_{BE(sat)}$ Base-emitter saturation voltage	$I_B = 0.2 \text{ A}$ $I_B = 0.5 \text{ A}$ $I_B = 1 \text{ A}$ $I_B = 1 \text{ A}$	$I_C = 1 \text{ A}$ $I_C = 2.5 \text{ A}$ $I_C = 4 \text{ A}$ $I_C = 4 \text{ A}$	$T_C = 100^\circ\text{C}$ (see Notes 3 and 4)			1.0 1.2 1.4 1.3	V
$f_t$ Current gain bandwidth product	$V_{CE} = 10 \text{ V}$	$I_C = 0.5 \text{ A}$	$f = 1 \text{ MHz}$		12		MHz
$C_{ob}$ Output capacitance	$V_{CB} = 20 \text{ V}$	$I_E = 0$	$f = 0.1 \text{ MHz}$		110		pF

NOTES: 2. Inductive loop switching measurement.

3. These parameters must be measured using pulse techniques,  $t_p = 300 \mu\text{s}$ , duty cycle  $\leq 2\%$ .

4. These parameters must be measured using voltage-sensing contacts, separate from the current carrying contacts.

### thermal characteristics

PARAMETER	MIN	TYP	MAX	UNIT
$R_{\theta JC}$ Junction to case thermal resistance			1.66	$^\circ\text{C/W}$

### inductive-load-switching characteristics at 25°C case temperature (unless otherwise noted)

PARAMETER	TEST CONDITIONS †			MIN	TYP	MAX	UNIT
$t_{sv}$ Voltage storage time	$I_C = 4 \text{ A}$ $V_{BE(off)} = -5 \text{ V}$	$I_{B(on)} = 0.8 \text{ A}$	(see Figures 1 and 2)			2	$\mu\text{s}$
$t_{rv}$ Voltage rise time						200	ns
$t_{fi}$ Current fall time						100	ns
$t_{ti}$ Current tail time						50	ns
$t_{xo}$ Cross over time						200	ns
$t_{sv}$ Voltage storage time	$I_C = 4 \text{ A}$ $V_{BE(off)} = -5 \text{ V}$	$I_{B(on)} = 0.8 \text{ A}$ $T_C = 100^\circ\text{C}$	(see Figures 1 and 2)			2.5	$\mu\text{s}$
$t_{rv}$ Voltage rise time						400	ns
$t_{fi}$ Current fall time						200	ns
$t_{ti}$ Current tail time						50	ns
$t_{xo}$ Cross over time						600	ns

† Voltage and current values shown are nominal; exact values vary slightly with transistor parameters.

## PRODUCT INFORMATION

PARAMETER MEASUREMENT INFORMATION

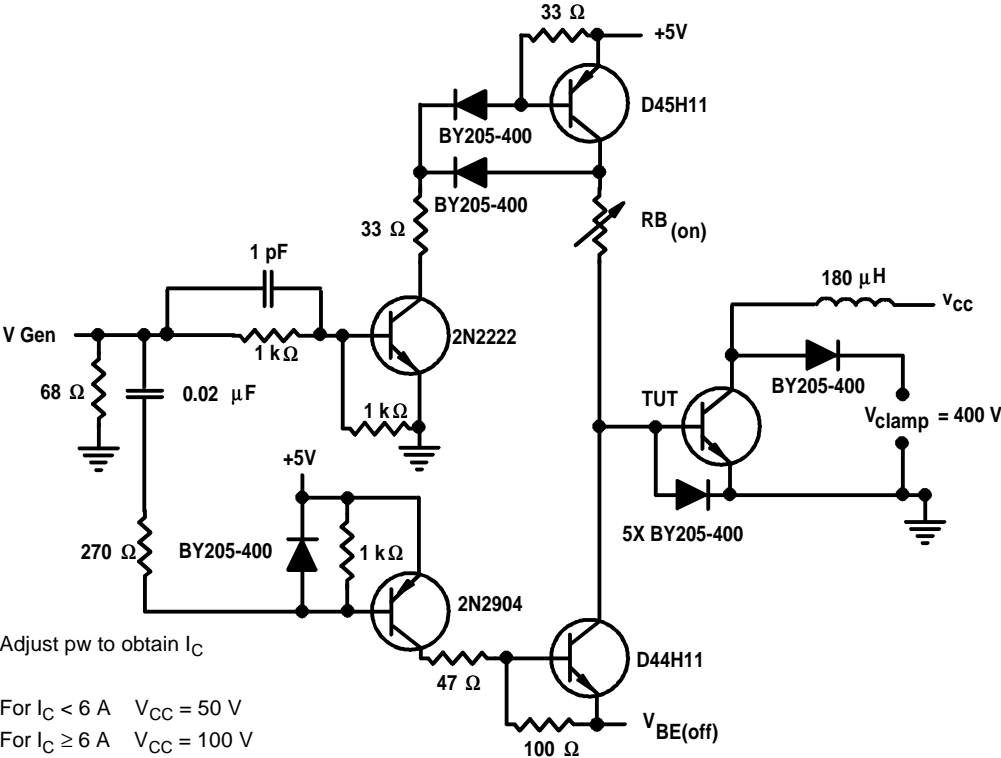
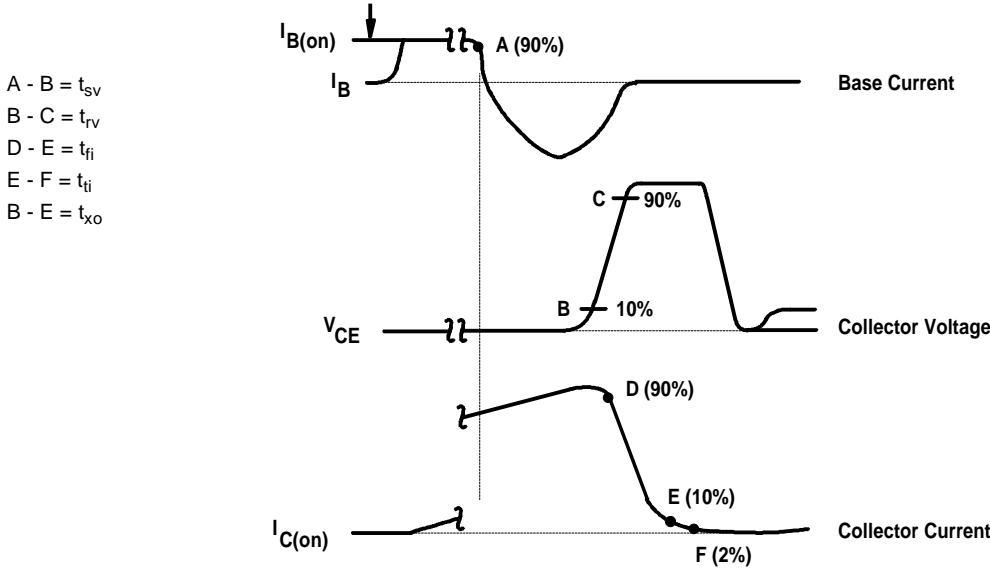

Figure 1. Inductive-Load Switching Test Circuit



NOTES: A. Waveforms are monitored on an oscilloscope with the following characteristics:  $t_r < 15 ns$ ,  $R_{in} > 10 \Omega$ ,  $C_{in} < 11.5 pF$ .  
 B. Resistors must be noninductive types.

Figure 2. Inductive-Load Switching Waveforms

# TIPL791, TIPL791A NPN SILICON POWER TRANSISTORS

MAY 1989 - REVISED MARCH 1997

## TYPICAL CHARACTERISTICS

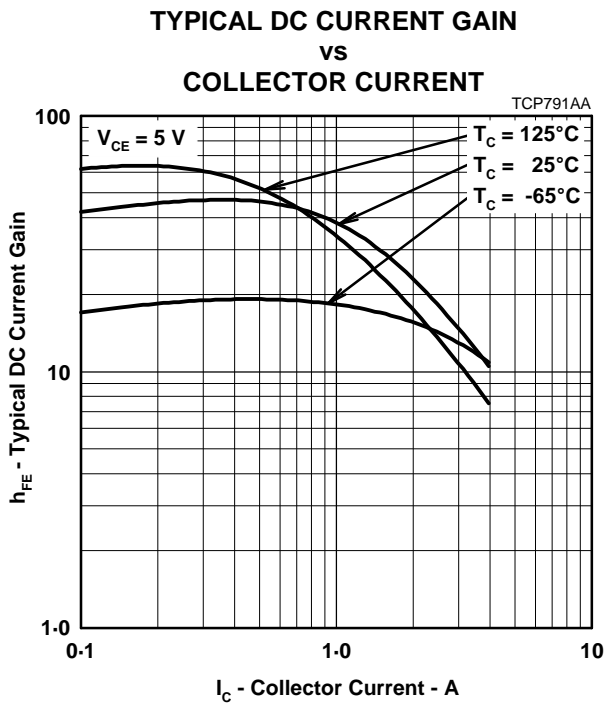

Figure 3.

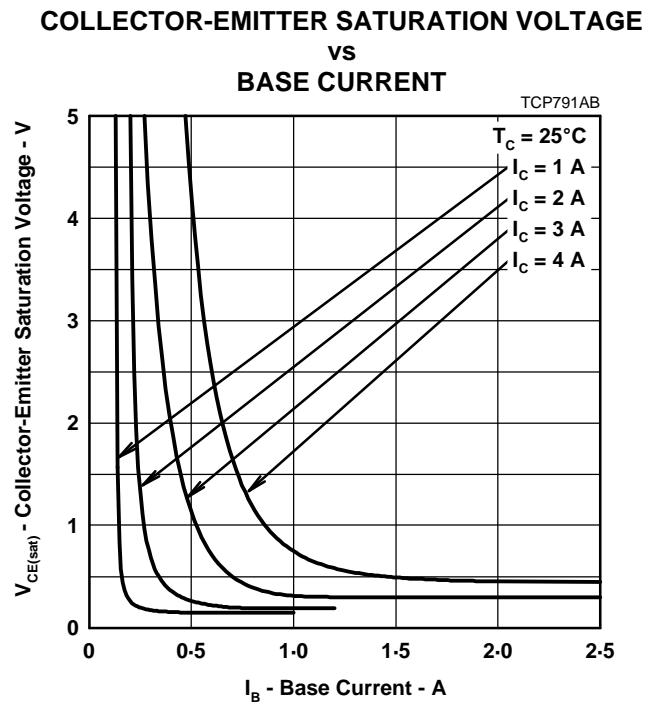

Figure 4.

## MAXIMUM SAFE OPERATING REGIONS

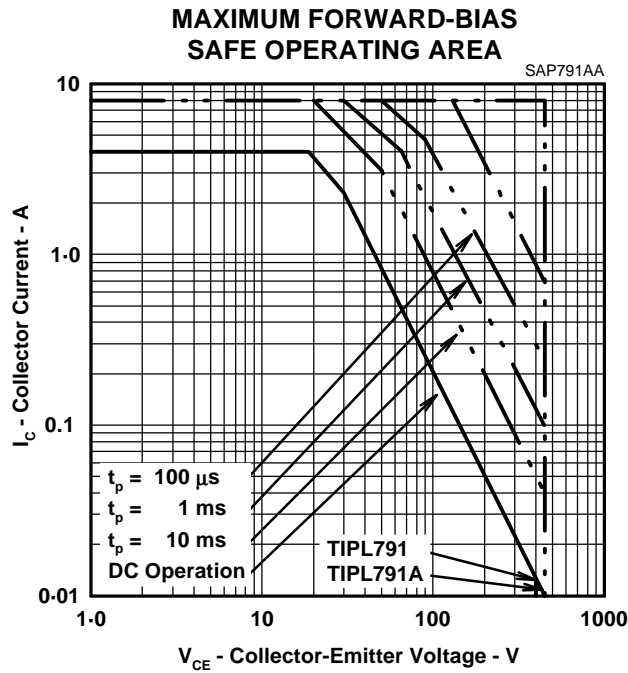

Figure 5.

THERMAL INFORMATION

THERMAL RESPONSE JUNCTION TO CASE  
VS  
POWER PULSE DURATION

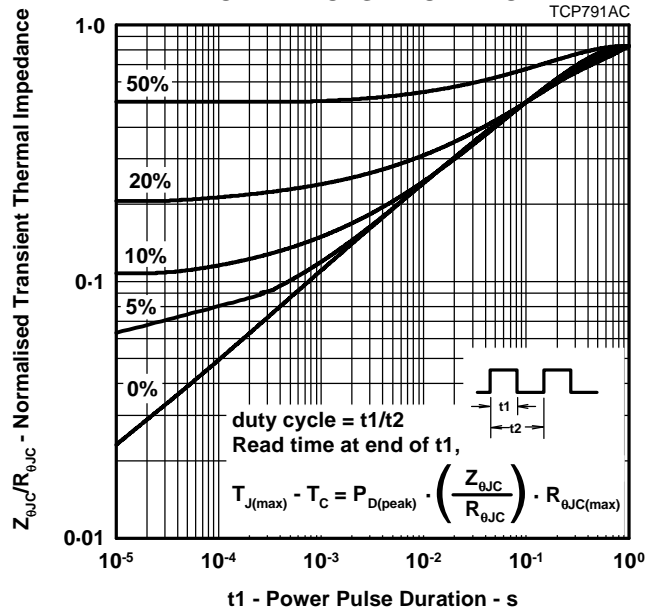

Figure 6.

# TIPL791, TIPL791A NPN SILICON POWER TRANSISTORS

MAY 1989 - REVISED MARCH 1997

## MECHANICAL DATA

### TO-220

#### 3-pin plastic flange-mount package

This single-in-line package consists of a circuit mounted on a lead frame and encapsulated within a plastic compound. The compound will withstand soldering temperature with no deformation, and circuit performance characteristics will remain stable when operated in high humidity conditions. Leads require no additional cleaning or processing when used in soldered assembly.

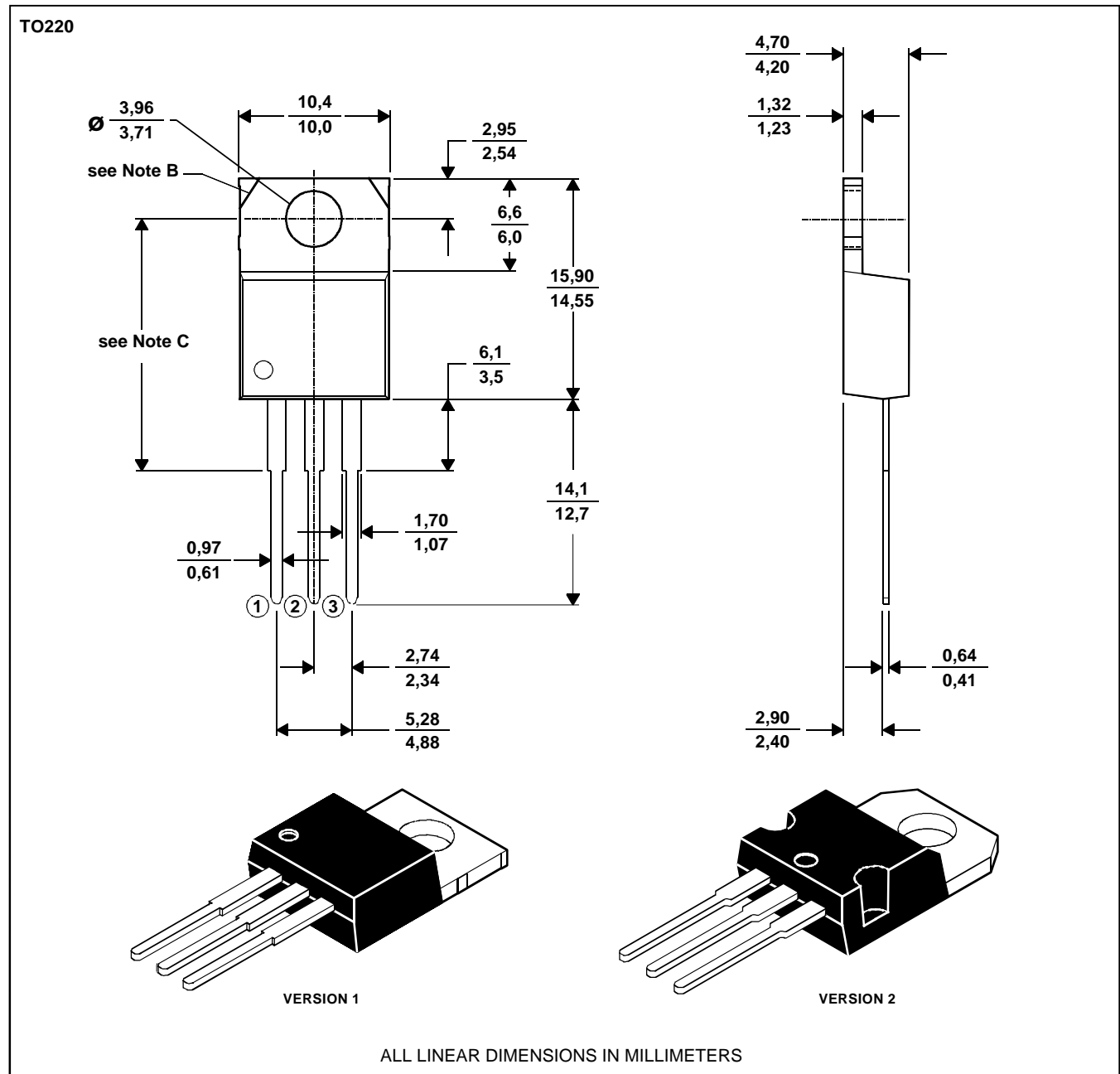

- NOTES: A. The centre pin is in electrical contact with the mounting tab.  
 B. Mounting tab corner profile according to package version.  
 C. Typical fixing hole centre stand off height according to package version.  
 Version 1, 18.0 mm. Version 2, 17.6 mm.

MDXXBE

## PRODUCT INFORMATION

### IMPORTANT NOTICE

Power Innovations Limited (PI) reserves the right to make changes to its products or to discontinue any semiconductor product or service without notice, and advises its customers to verify, before placing orders, that the information being relied on is current.

PI warrants performance of its semiconductor products to the specifications applicable at the time of sale in accordance with PI's standard warranty. Testing and other quality control techniques are utilized to the extent PI deems necessary to support this warranty. Specific testing of all parameters of each device is not necessarily performed, except as mandated by government requirements.

PI accepts no liability for applications assistance, customer product design, software performance, or infringement of patents or services described herein. Nor is any license, either express or implied, granted under any patent right, copyright, design right, or other intellectual property right of PI covering or relating to any combination, machine, or process in which such semiconductor products or services might be or are used.

PI SEMICONDUCTOR PRODUCTS ARE NOT DESIGNED, INTENDED, AUTHORIZED, OR WARRANTED TO BE SUITABLE FOR USE IN LIFE-SUPPORT APPLICATIONS, DEVICES OR SYSTEMS.

Copyright © 1997, Power Innovations Limited