

# DATA SHEET

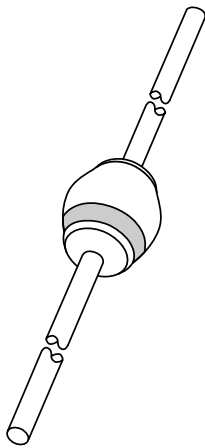

## **BYM26 series** Fast soft-recovery controlled avalanche rectifiers

Product specification  
Supersedes data of February 1994

1996 May 24

## Fast soft-recovery controlled avalanche rectifiers

## BYM26 series

### FEATURES

- Glass passivated
- High maximum operating temperature
- Low leakage current
- Excellent stability
- Guaranteed avalanche energy absorption capability
- Available in ammo-pack
- Also available with preformed leads for easy insertion.

### DESCRIPTION

Rugged glass SOD64 package, using a high temperature alloyed

construction. This package is hermetically sealed and fatigue free as coefficients of expansion of all used parts are matched.

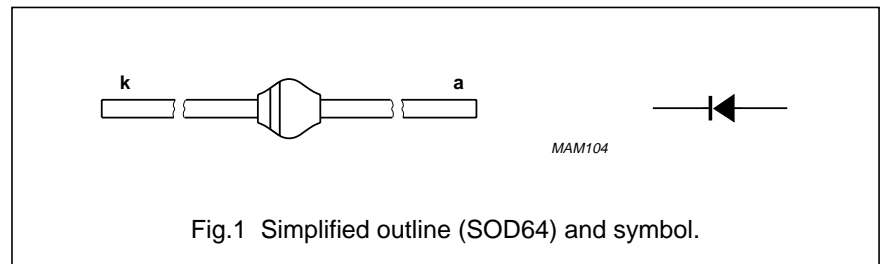

### LIMITING VALUES

In accordance with the Absolute Maximum Rating System (IEC 134).

SYMBOL	PARAMETER	CONDITIONS	MIN.	MAX.	UNIT
$V_{RRM}$	repetitive peak reverse voltage				
	BYM26A		–	200	V
	BYM26B		–	400	V
	BYM26C		–	600	V
	BYM26D		–	800	V
	BYM26E		–	1000	V
	BYM26F BYM26G		–	1200 1400	V V
$V_R$	continuous reverse voltage				
	BYM26A		–	200	V
	BYM26B		–	400	V
	BYM26C		–	600	V
	BYM26D		–	800	V
	BYM26E		–	1000	V
	BYM26F BYM26G		–	1200 1400	V V
$I_{F(AV)}$	average forward current	$T_{tp} = 55\text{ }^\circ\text{C}$ ; lead length = 10 mm; see Figs 2 and 3; averaged over any 20 ms period; see also Figs 10 and 11	–	2.30	A
	BYM26A to E BYM26F and G		–	2.40	A
$I_{F(AV)}$	average forward current	$T_{amb} = 65\text{ }^\circ\text{C}$ ; PCB mounting (see Fig.19); see Figs 4 and 5; averaged over any 20 ms period; see also Figs 10 and 11	–	1.05	A
	BYM26A to E BYM26F and G		–	1.00	A

## Fast soft-recovery controlled avalanche rectifiers

## BYM26 series

SYMBOL	PARAMETER	CONDITIONS	MIN.	MAX.	UNIT
$I_{FRM}$	repetitive peak forward current	$T_{tp} = 55\text{ °C}$ ; see Figs 6 and 7	–	19	A
	BYM26A to E		–	21	A
$I_{FRM}$	repetitive peak forward current	$T_{amb} = 65\text{ °C}$ ; see Figs 8 and 9	–	8.0	A
	BYM26F and G		–	8.5	A
$I_{FSM}$	non-repetitive peak forward current	$t = 10\text{ ms}$ half sine wave; $T_j = T_{jmax}$ prior to surge; $V_R = V_{RRMmax}$	–	45	A
$E_{RSM}$	non-repetitive peak reverse avalanche energy	$L = 120\text{ mH}$ ; $T_j = T_{jmax}$ prior to surge; inductive load switched off	–	10	mJ
$T_{stg}$	storage temperature		–65	+175	°C
$T_j$	junction temperature	see Figs 12 and 13	–65	+175	°C

### ELECTRICAL CHARACTERISTICS

$T_j = 25\text{ °C}$  unless otherwise specified.

SYMBOL	PARAMETER	CONDITIONS	MIN.	TYP.	MAX.	UNIT
$V_F$	forward voltage	$I_F = 2\text{ A}$ ; $T_j = T_{jmax}$ ; see Figs 14 and 15	–	–	1.34	V
	BYM26A to E		–	–	1.34	V
$V_F$	forward voltage	$I_F = 2\text{ A}$ ; see Figs 14 and 15	–	–	2.65	V
	BYM26F and G		–	–	2.30	V
$V_{(BR)R}$	reverse avalanche breakdown voltage	$I_R = 0.1\text{ mA}$				
	BYM26A		300	–	–	V
	BYM26B		500	–	–	V
	BYM26C		700	–	–	V
	BYM26D		900	–	–	V
	BYM26E		1100	–	–	V
	BYM26F and G		1300	–	–	V
$I_R$	reverse current	$V_R = V_{RRMmax}$ ; see Fig.16	–	–	10	μA
		$V_R = V_{RRMmax}$ ; $T_j = 165\text{ °C}$ ; see Fig.16	–	–	150	μA
$t_{rr}$	reverse recovery time	when switched from $I_F = 0.5\text{ A}$ to $I_R = 1\text{ A}$ ; measured at $I_R = 0.25\text{ A}$ ; see Fig.20	–	–	30	ns
	BYM26A to C		–	–	75	ns
	BYM26D and E		–	–	150	ns
	BYM26F and G					

## Fast soft-recovery controlled avalanche rectifiers

## BYM26 series

SYMBOL	PARAMETER	CONDITIONS	MIN.	TYP.	MAX.	UNIT
C <sub>d</sub>	diode capacitance	f = 1 MHz; V <sub>R</sub> = 0 V; see Figs 17 and 18				
	BYM26A to C		–	85	–	pF
	BYM26D and E		–	75	–	pF
	BYM26F and G		–	65	–	pF
$\left  \frac{dI_R}{dt} \right $	maximum slope of reverse recovery current	when switched from I <sub>F</sub> = 1 A to V <sub>R</sub> ≥ 30 V and dI <sub>F</sub> /dt = –1 A/μs; see Fig.21				
	BYM26A to C		–	–	7	A/μs
	BYM26D and E		–	–	6	A/μs
	BYM26F and G		–	–	5	A/μs

### THERMAL CHARACTERISTICS

SYMBOL	PARAMETER	CONDITIONS	VALUE	UNIT
R <sub>th j-tp</sub>	thermal resistance from junction to tie-point	lead length = 10 mm	25	K/W
R <sub>th j-a</sub>	thermal resistance from junction to ambient	note 1	75	K/W

### Note

1. Device mounted on an epoxy-glass printed-circuit board, 1.5 mm thick; thickness of Cu-layer ≥40 μm, see Fig.19. For more information please refer to the "General Part of associated Handbook".

Fast soft-recovery  
controlled avalanche rectifiers

BYM26 series

GRAPHICAL DATA

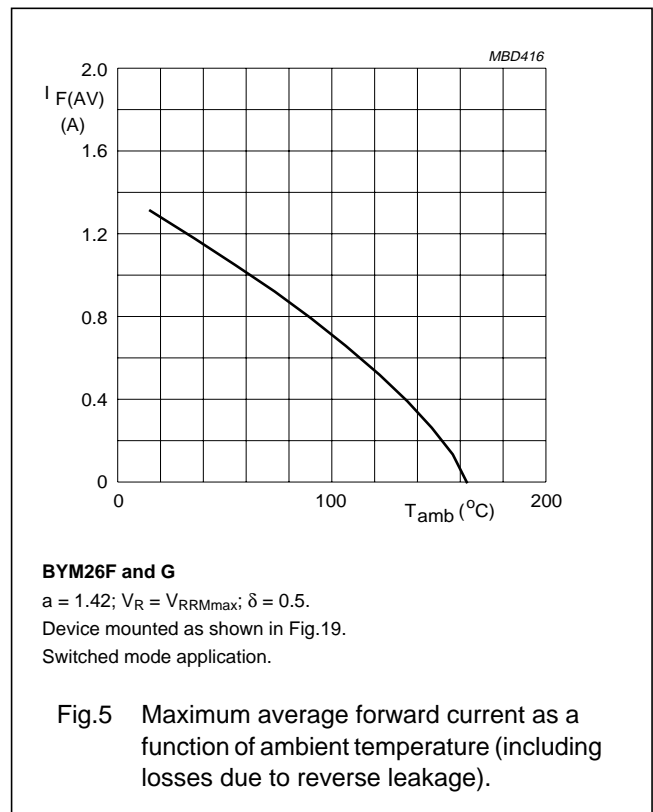
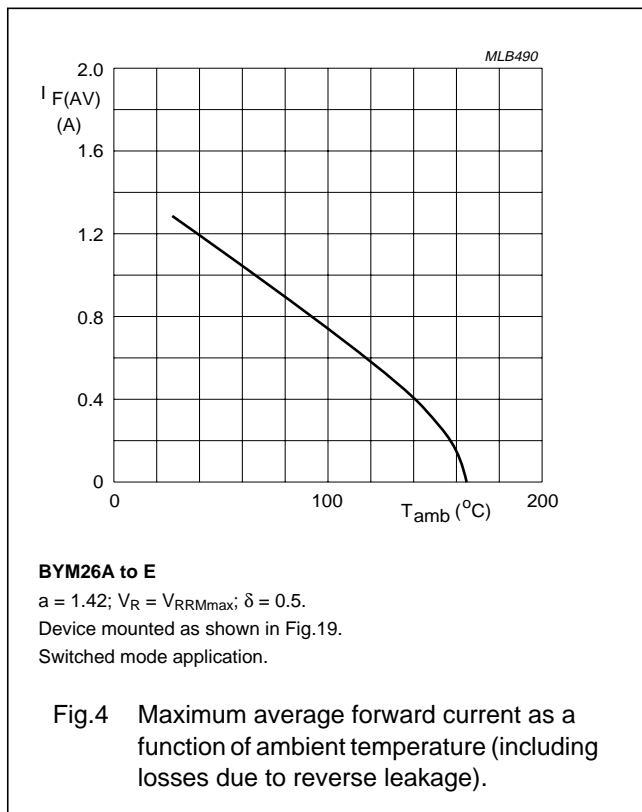
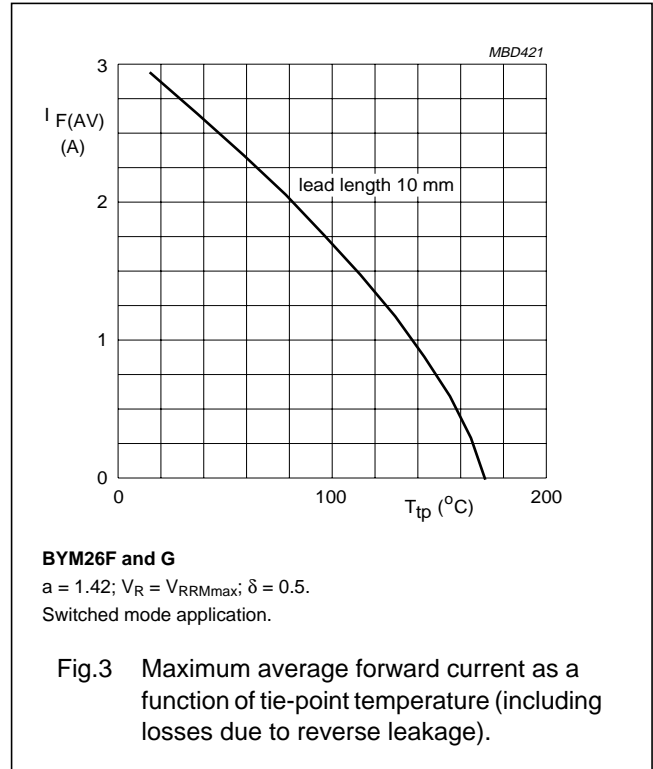
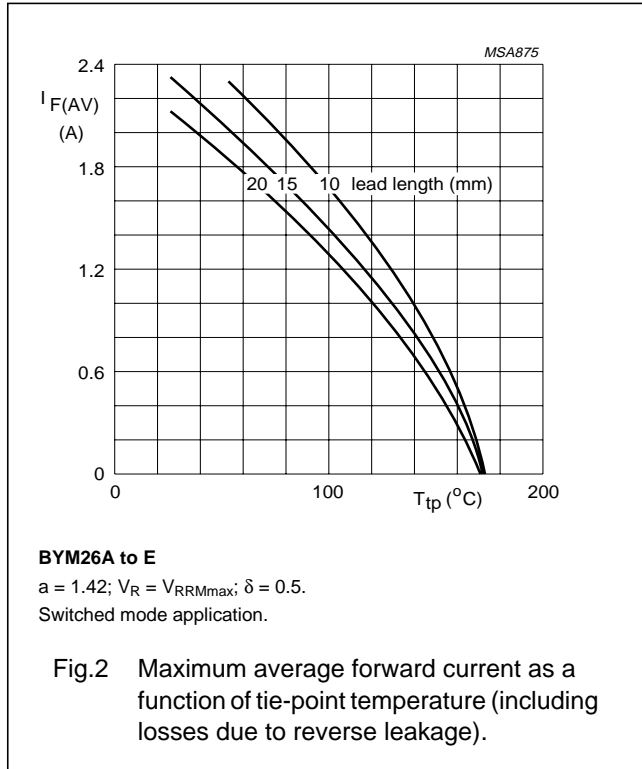

Fast soft-recovery  
controlled avalanche rectifiers

BYM26 series

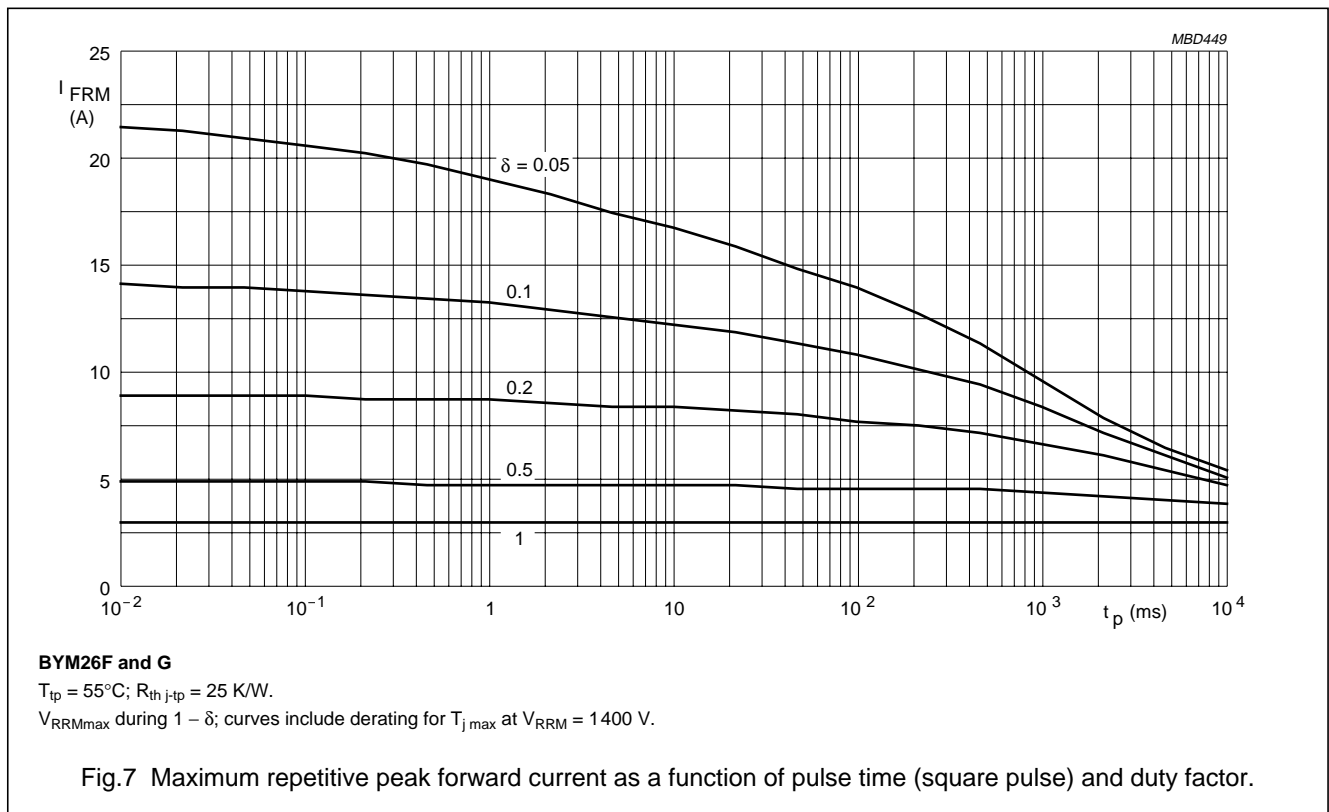
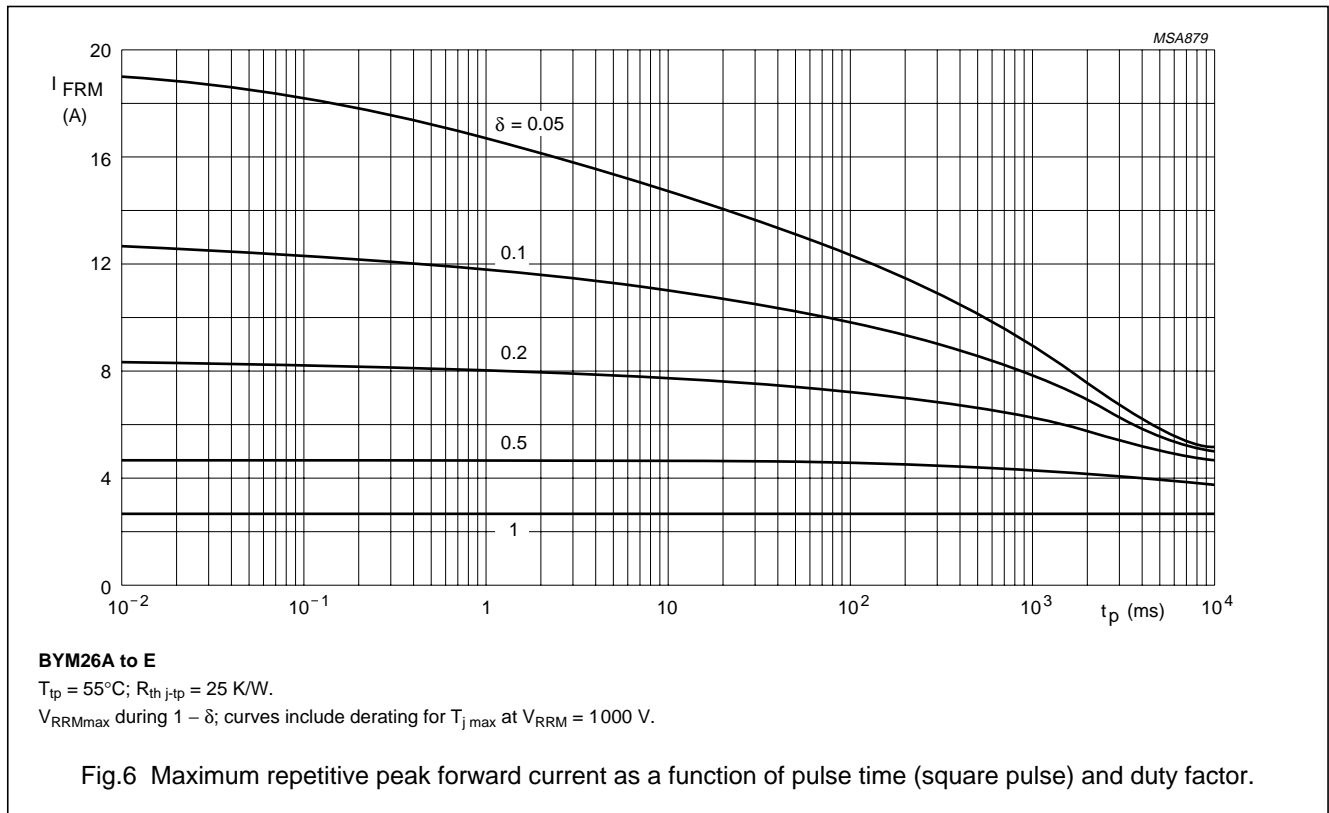

Fast soft-recovery  
controlled avalanche rectifiers

BYM26 series

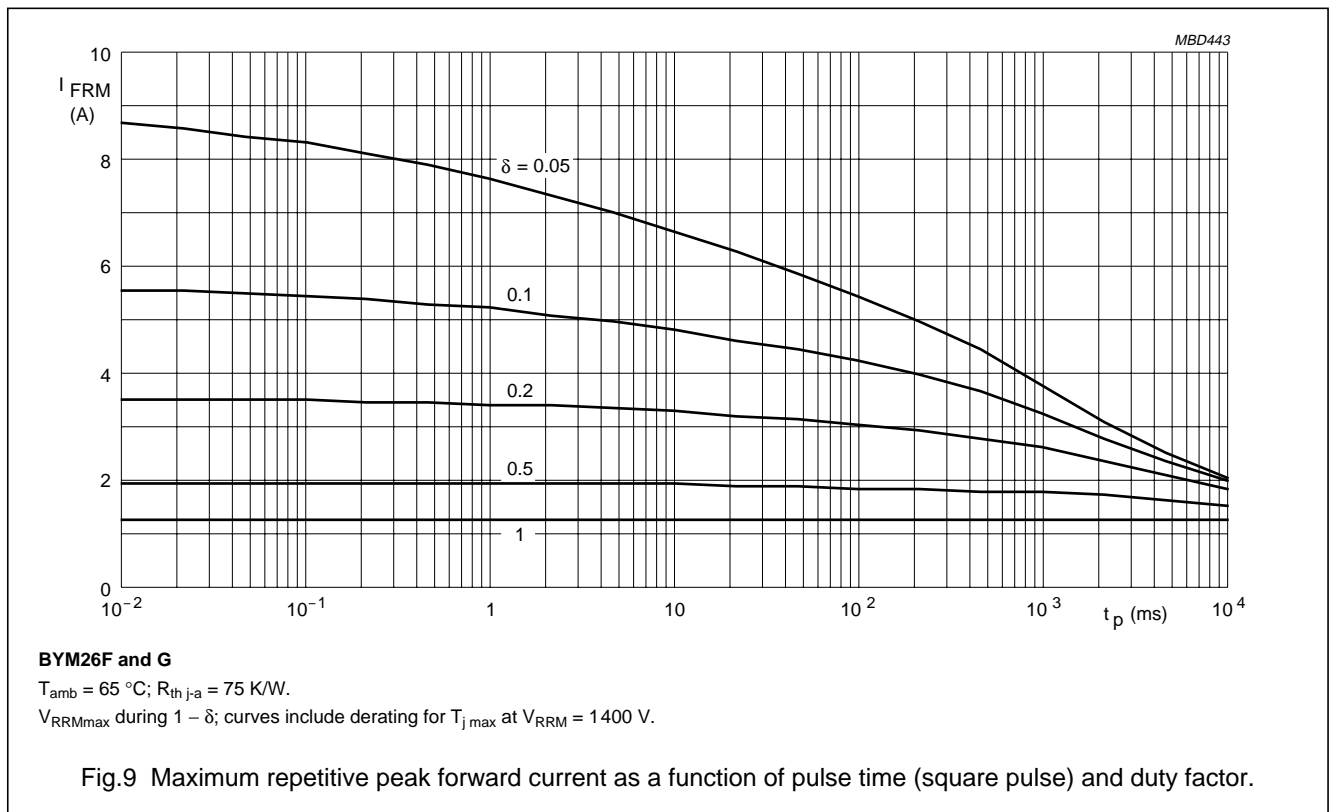
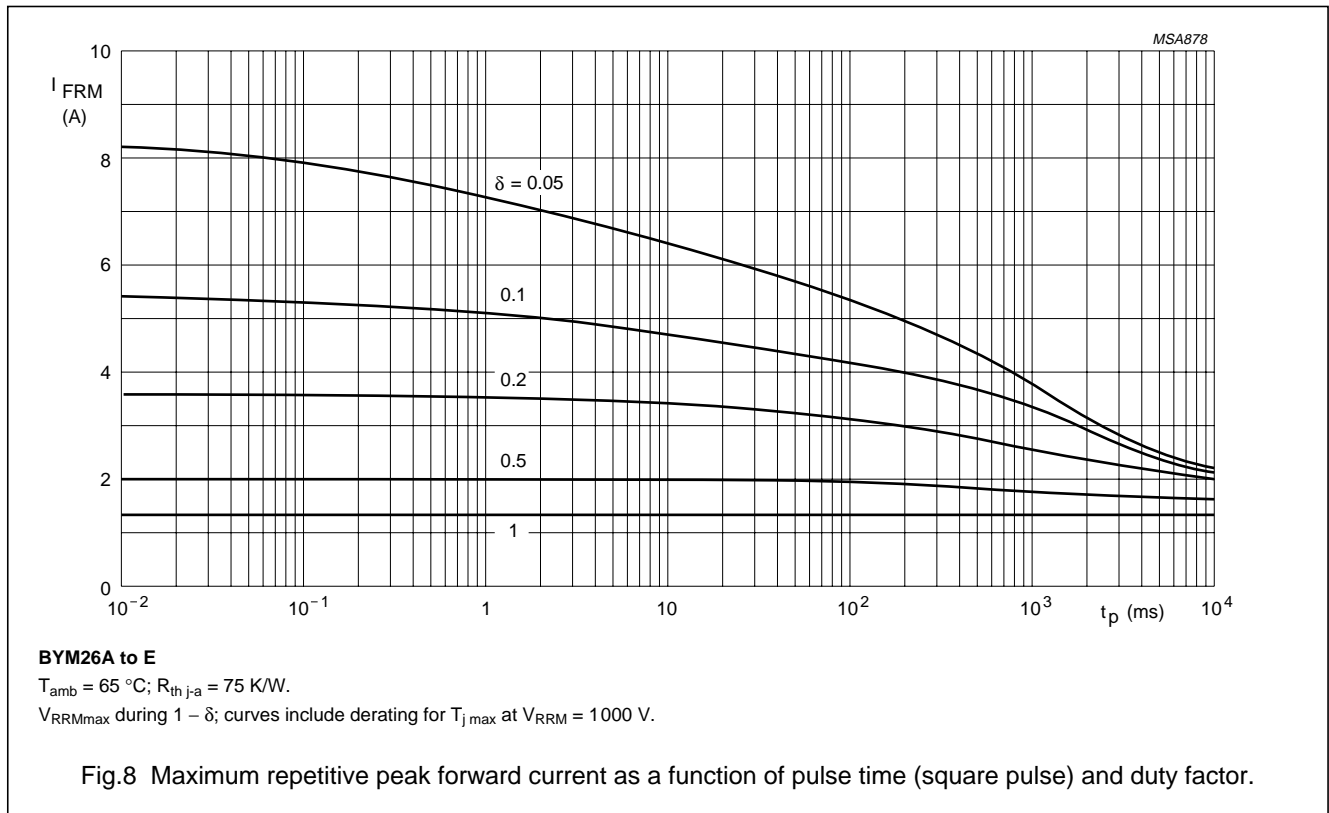

Fast soft-recovery  
controlled avalanche rectifiers

BYM26 series

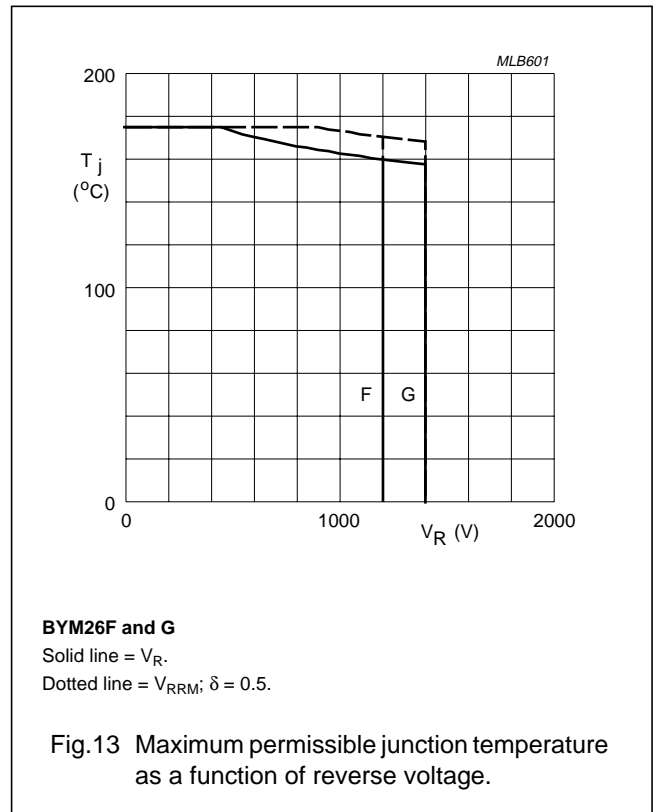
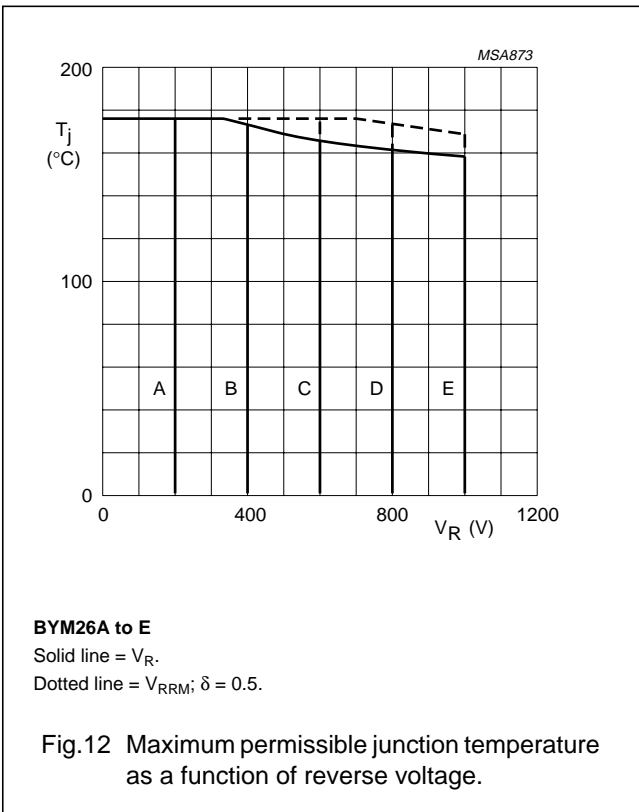
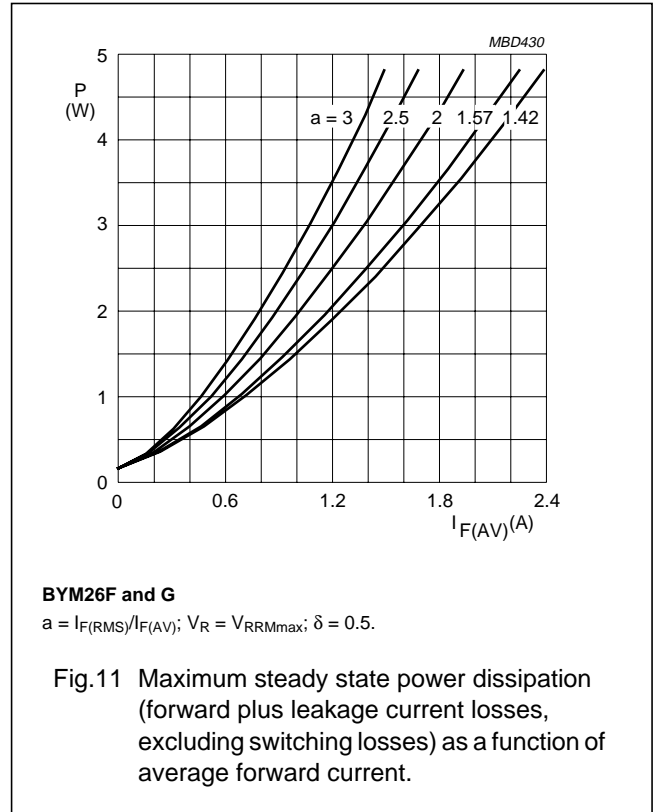
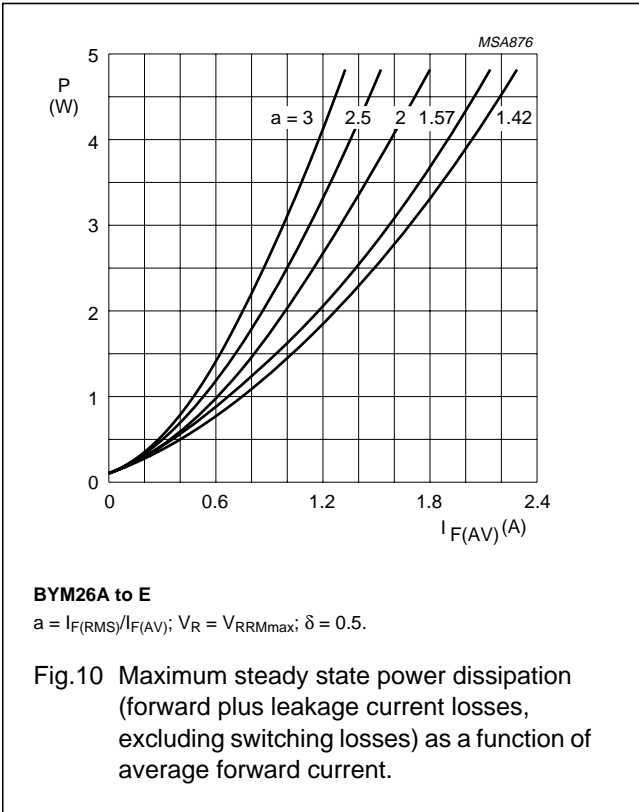



Fast soft-recovery  
controlled avalanche rectifiers

BYM26 series

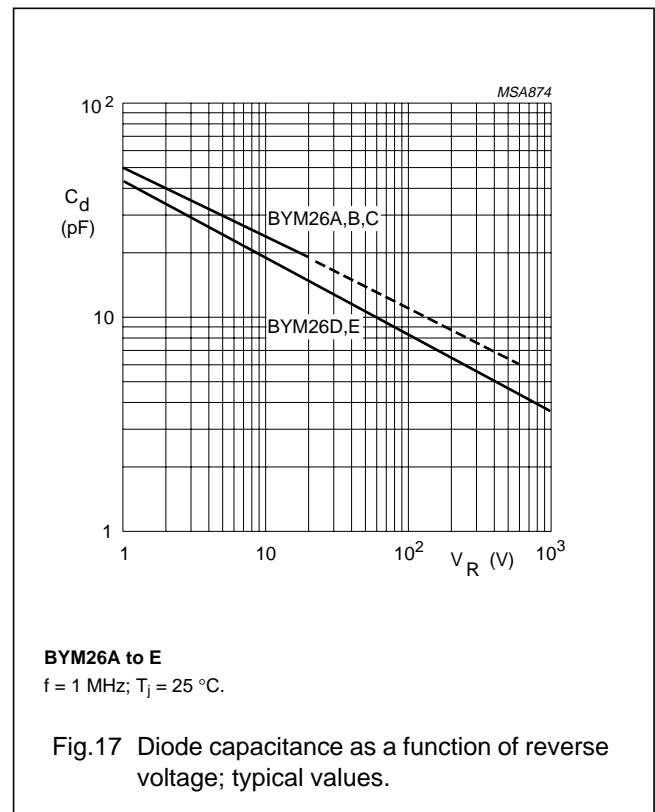
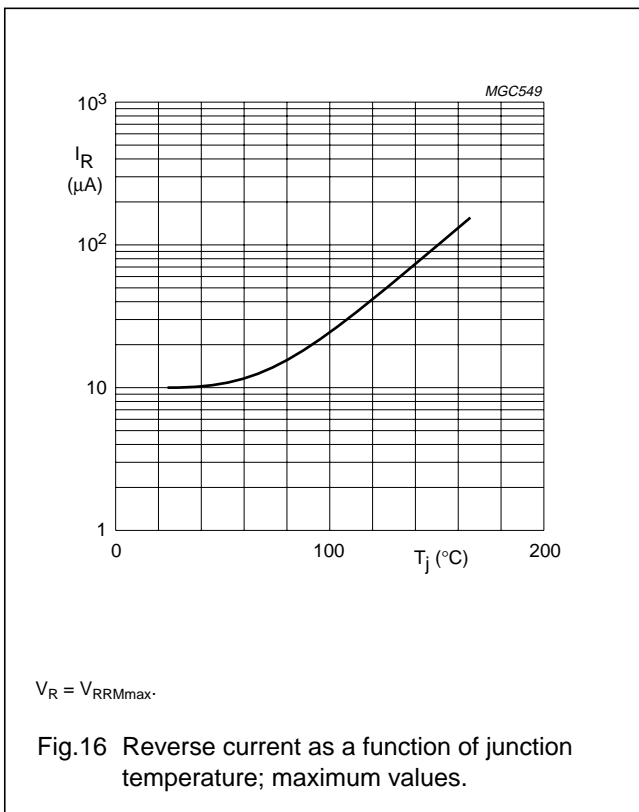
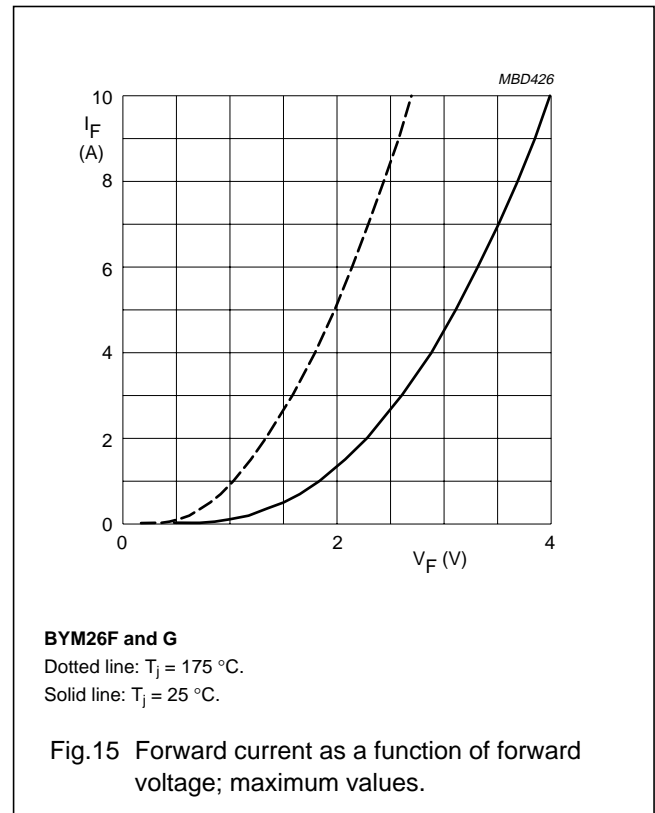
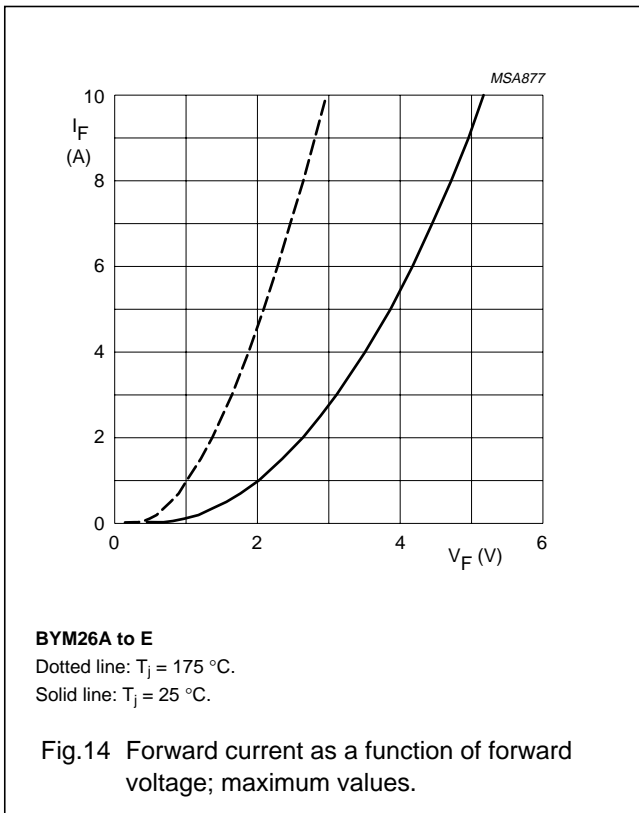

Fast soft-recovery controlled avalanche rectifiers

BYM26 series

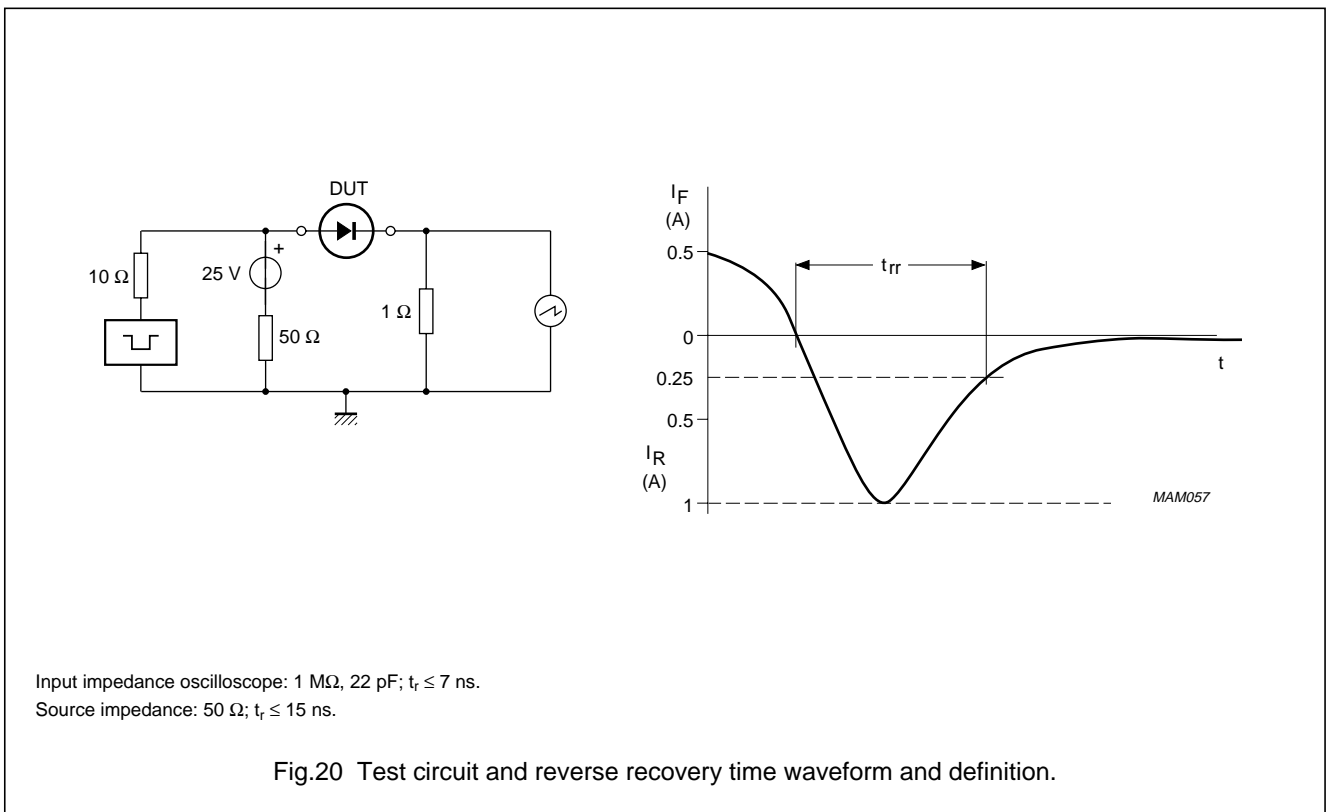
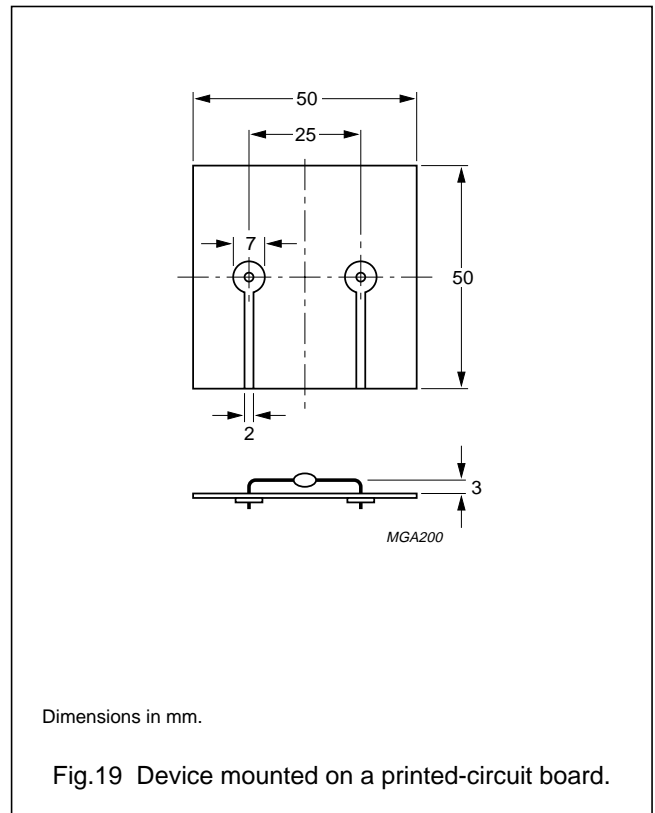
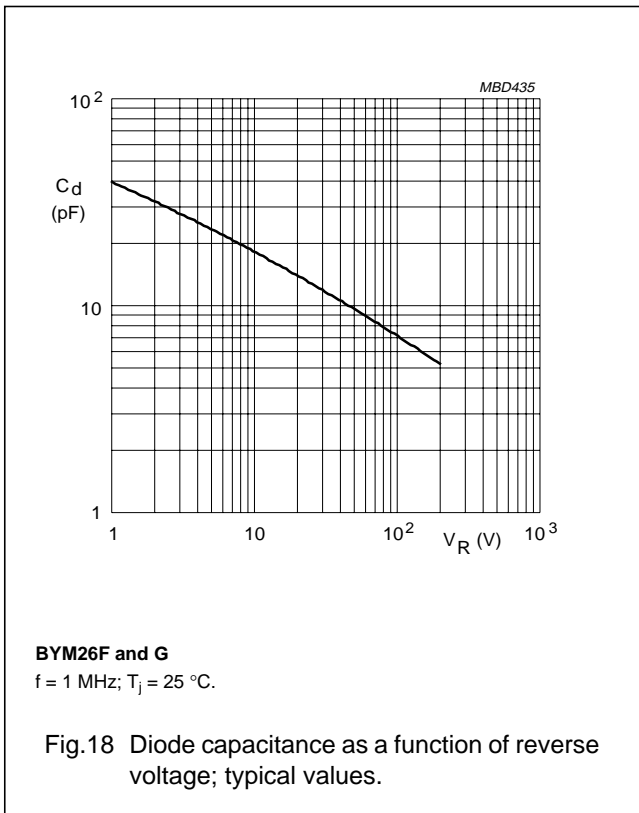

Fast soft-recovery  
controlled avalanche rectifiers

BYM26 series

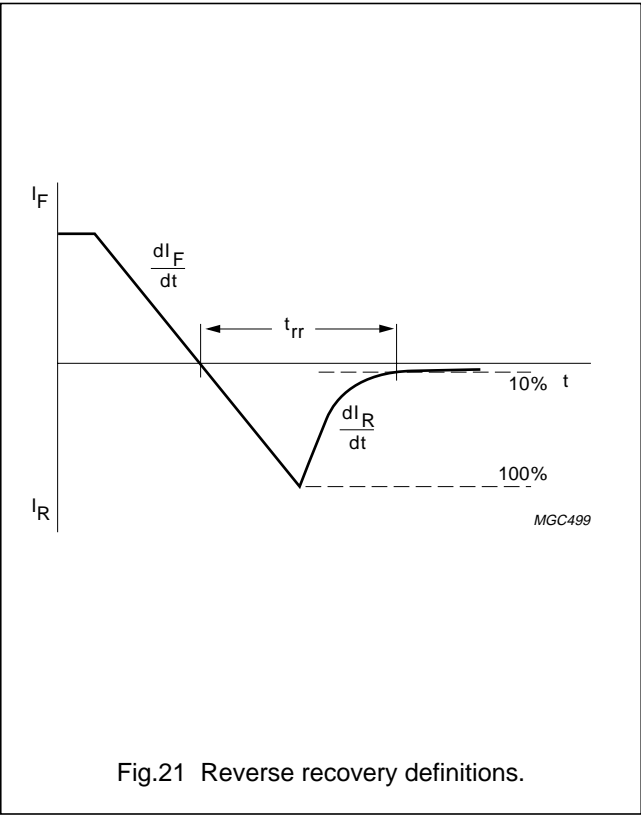
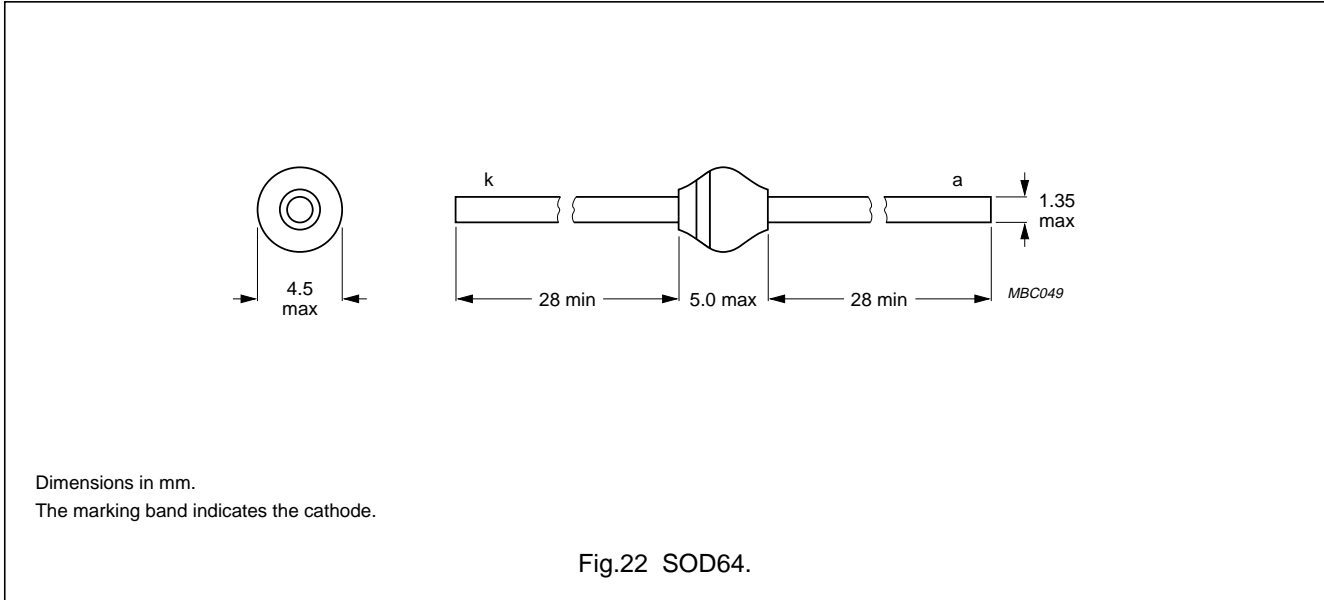

Fig.21 Reverse recovery definitions.

Fast soft-recovery  
controlled avalanche rectifiers

BYM26 series

PACKAGE OUTLINE



DEFINITIONS

<b>Data Sheet Status</b>	
Objective specification	This data sheet contains target or goal specifications for product development.
Preliminary specification	This data sheet contains preliminary data; supplementary data may be published later.
Product specification	This data sheet contains final product specifications.
<b>Limiting values</b>	
Limiting values given are in accordance with the Absolute Maximum Rating System (IEC 134). Stress above one or more of the limiting values may cause permanent damage to the device. These are stress ratings only and operation of the device at these or at any other conditions above those given in the Characteristics sections of the specification is not implied. Exposure to limiting values for extended periods may affect device reliability.	
<b>Application information</b>	
Where application information is given, it is advisory and does not form part of the specification.	

LIFE SUPPORT APPLICATIONS

These products are not designed for use in life support appliances, devices, or systems where malfunction of these products can reasonably be expected to result in personal injury. Philips customers using or selling these products for use in such applications do so at their own risk and agree to fully indemnify Philips for any damages resulting from such improper use or sale.