

# Low $V_{CE(sat)}$ Transistor(Strobe flash)

## 2SD2098 / 2SD2118 / 2SD2097 / 2SD2166

●Features

1) Low  $V_{CE(sat)}$ .

$$V_{CE(sat)} = 0.25V \text{ (Typ.)}$$

$$(I_c / I_B = 4A / 0.1A)$$

2) Excellent DC current gain characteristics.

3) Complements the  
2SB1386 / 2SB1412 / 2SB1326 /  
2SB1436.

●Structure

Epitaxial planar type  
NPN silicon transistor

●External dimensions (Units: mm)

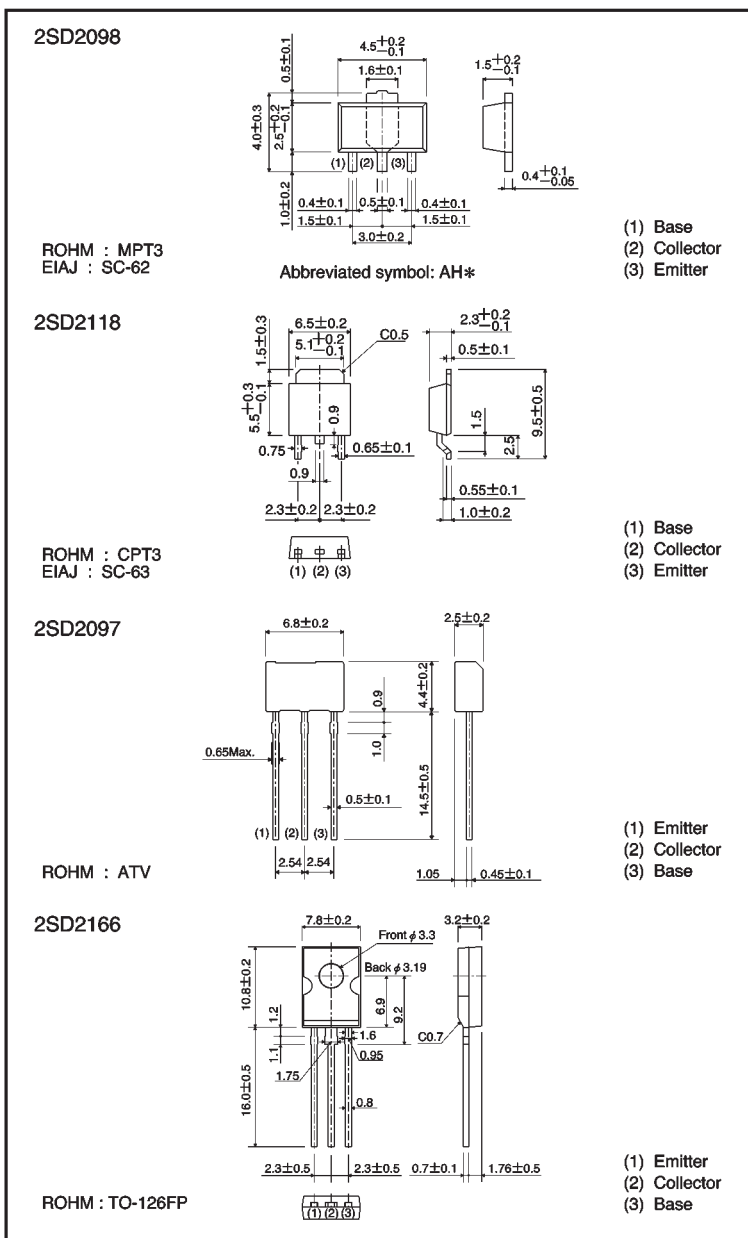

\* Denotes hFE

(96-229-D204)

## ● Absolute maximum ratings (Ta = 25°C)

Parameter		Symbol	Limits	Unit
Collector-base voltage		V <sub>CB0</sub>	50	V
Collector-emitter voltage		V <sub>CEO</sub>	20	V
Emitter-base voltage		V <sub>EBO</sub>	6	V
Collector current		I <sub>c</sub>	5	A(DC)
		I <sub>cP</sub>	10	A(Pulse) *1
Collector power dissipation	2SD2098	P <sub>c</sub>	0.5	W *2
			2	
	1			
	2SD2118		10	W(T <sub>c</sub> =25°C)
	2SD2097		1	W *3
	2SD2116		1.5	
Junction temperature		T <sub>j</sub>	150	°C
Storage temperature		T <sub>stg</sub>	-55~+150	°C

\*1 Single pulse P<sub>w</sub>=10ms

\*2 When mounted on a 40×40×0.7 mm ceramic board.

\*3 Printed circuit board glass epoxy board, 1.6 mm thick with copper plating 100mm<sup>2</sup> or larger.

## ● Electrical characteristics (Ta = 25°C)

Parameter	Symbol	Min.	Typ.	Max.	Unit	Conditions
Collector-base breakdown voltage	BV <sub>CB0</sub>	50	—	—	V	I <sub>c</sub> =50 μA
Collector-emitter breakdown voltage	BV <sub>CEO</sub>	20	—	—	V	I <sub>c</sub> =1mA
Emitter-base breakdown voltage	BV <sub>EBO</sub>	6	—	—	V	I <sub>E</sub> =50 μA
Collector cutoff current	I <sub>CB0</sub>	—	—	0.5	μA	V <sub>CB</sub> =40V
Emitter cutoff current	I <sub>EBO</sub>	—	—	0.5	μA	V <sub>EB</sub> =5V
Collector-emitter saturation voltage	V <sub>CE(sat)</sub>	—	0.25	1.0	V	I <sub>c</sub> /I <sub>B</sub> =4A/0.1A *
DC current transfer ratio	h <sub>FE</sub>	120	—	390	—	V <sub>CE</sub> =2V, I <sub>c</sub> =0.5A *
Transition frequency	f <sub>T</sub>	—	150	—	MHz	V <sub>CE</sub> =6V, I <sub>E</sub> =-50mA, f=100MHz
Output capacitance	C <sub>ob</sub>	—	30	—	pF	V <sub>CE</sub> =20V, I <sub>E</sub> =0A, f=1MHz

\* Measured using pulse current.

● Packaging specifications and h<sub>FE</sub>

Type	h <sub>FE</sub>	Package	Taping			Bulk
		Code	T100	TL	TV2	—
		Basic ordering unit (pieces)	1000	2500	2500	1000
2SD2098	QR	○	—	—	—	
2SD2118	QR	—	○	—	—	
2SD2097	QR	—	—	○	—	
2SD2166	QR	—	—	—	○	

$h_{FE}$  values are classified as follows :

Item	Q	R
$h_{FE}$	120~270	180~390

● Electrical characteristic curves

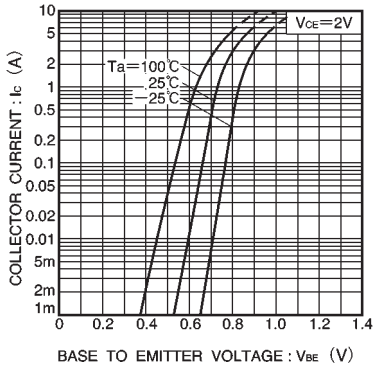

Fig.1 Grounded emitter propagation characteristics

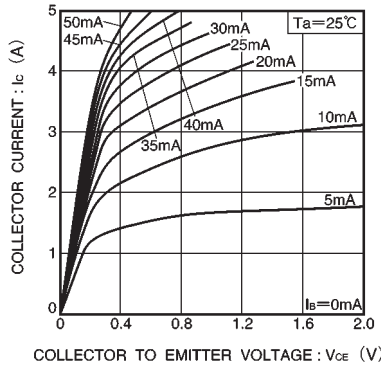

Fig.2 Grounded emitter output characteristics

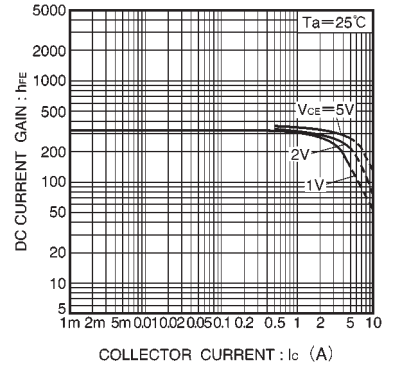

Fig.3 DC current gain vs. collector current ( I )

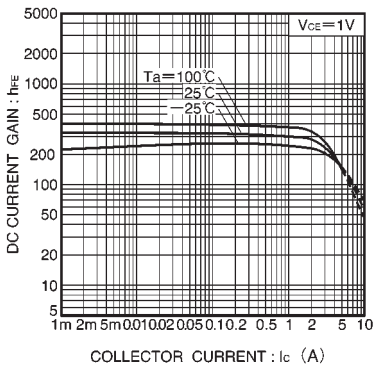

Fig.4 DC current gain vs. collector current ( II )

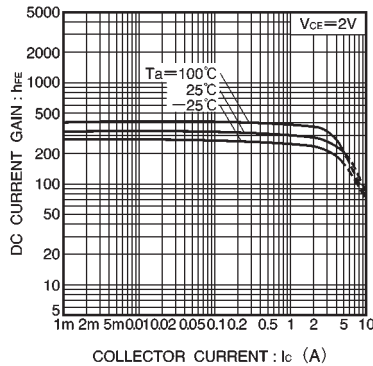

Fig.5 DC current gain vs. collector current ( III )

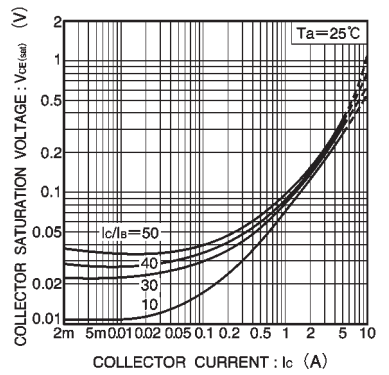

Fig.6 Collector-emitter saturation voltage vs. collector current ( I )

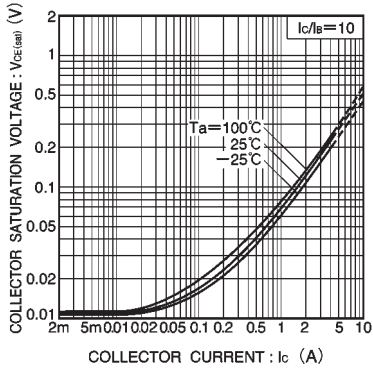

Fig.7 Collector-emitter saturation voltage vs. collector current (II)

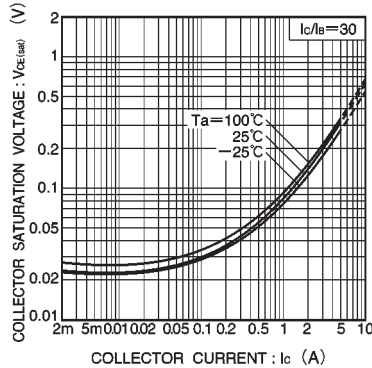

Fig.8 Collector-emitter saturation voltage vs. collector current (III)

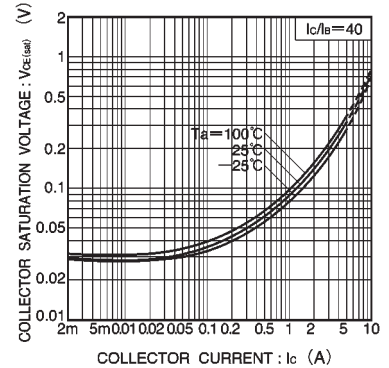

Fig.9 Collector-emitter saturation voltage vs. collector current (IV)

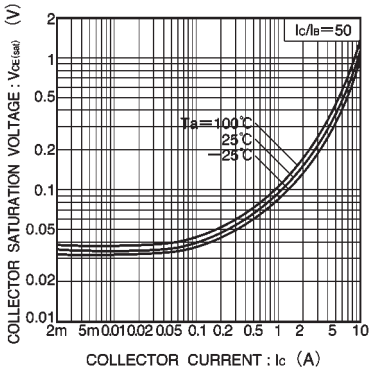

Fig.10 Collector-emitter saturation voltage vs. collector current (V)

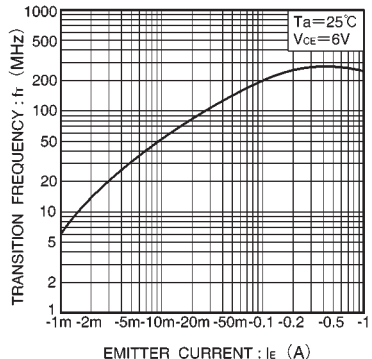

Fig.11 Gain bandwidth product vs. emitter current

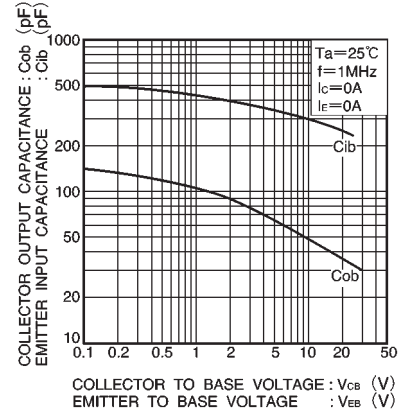

Fig.12 Collector output capacitance vs. collector-base voltage  
Emitter input capacitance vs. emitter-base voltage

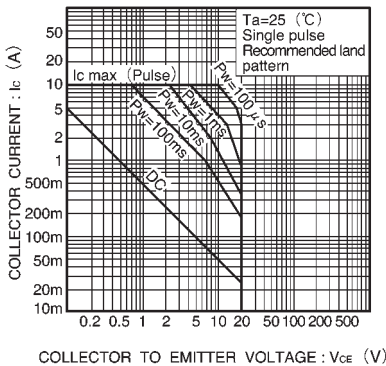

Fig.13 Safe operating area (2SD2098)

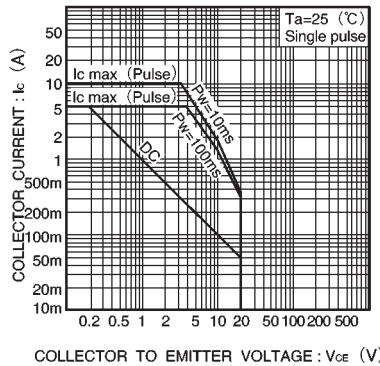

Fig.14 Safe operating area (2SD2118)