

P-Channel 30-V (D-S) MOSFET

CHARACTERISTICS

- P-Channel Vertical DMOS
- Macro Model (Subcircuit Model)
- Level 3 MOS
- Apply for both Linear and Switching Application
- Accurate over the -55 to 125°C Temperature Range
- Model the Gate Charge, Transient, and Diode Reverse Recovery Characteristics

DESCRIPTION

The attached spice model describes the typical electrical characteristics of the p-channel vertical DMOS. The subcircuit model is extracted and optimized over the -55 to 125°C temperature ranges under the pulsed 0 to 5V gate drive. The saturated output impedance is best fit at the gate bias near the threshold voltage.

A novel gate-to-drain feedback capacitance network is used to model the gate charge characteristics while avoiding convergence difficulties of the switched C_{gd} model. All model parameter values are optimized to provide a best fit to the measured electrical data and are not intended as an exact physical interpretation of the device.

SUBCIRCUIT MODEL SCHEMATIC

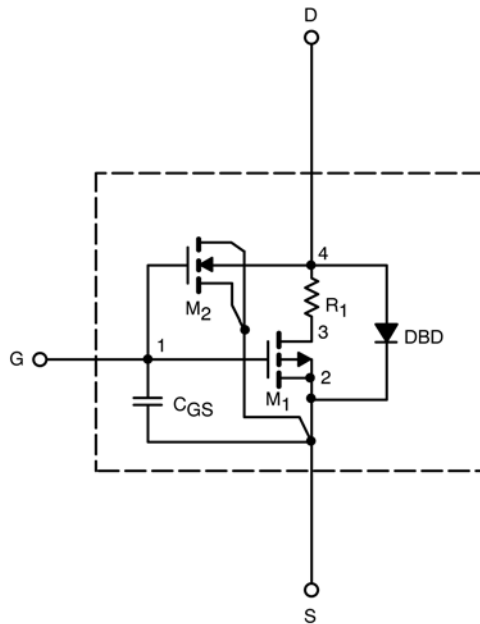

This document is intended as a SPICE modeling guideline and does not constitute a commercial product data sheet. Designers should refer to the appropriate data sheet of the same number for guaranteed specification limits.



SPECIFICATIONS ($T_J = 25^\circ\text{C}$ UNLESS OTHERWISE NOTED)				
Parameter	Symbol	Test Conditions	Typical	Unit
Static				
Gate Threshold Voltage	$V_{GS(th)}$	$V_{DS} = V_{GS}, I_D = -250 \mu\text{A}$	2.2	V
On-State Drain Current ^a	$I_{D(on)}$	$V_{DS} = -5 \text{ V}, V_{GS} = -10 \text{ V}$	117	A
		$V_{DS} = -5 \text{ V}, V_{GS} = -4.5 \text{ V}$	14	
Drain-Source On-State Resistance ^a	$r_{DS(on)}$	$V_{GS} = -10 \text{ V}, I_D = -5.3 \text{ A}$	0.033	Ω
		$V_{GS} = -6 \text{ V}, I_D = -3.6 \text{ A}$	0.042	
		$V_{GS} = -4.5 \text{ V}, I_D = -2.0 \text{ A}$	0.055	
Forward Transconductance ^a	g_{fs}	$V_{DS} = -15 \text{ V}, I_D = -5.3 \text{ A}$	9.3	S
Diode Forward Voltage ^a	V_{SD}	$I_S = -2.4 \text{ A}, V_{GS} = 0 \text{ V}$	-0.76	V
Dynamic^b				
Total Gate Charge ^b	Q_g	$V_{DS} = -10 \text{ V}, V_{GS} = -10 \text{ V}, I_D = -5.3 \text{ A}$	26.4	nC
Gate-Source Charge ^b	Q_{gs}		4.5	
Gate-Drain Charge ^b	Q_{gd}		5.6	
Turn-On Delay Time ^b	$t_{d(on)}$	$V_{DD} = -10 \text{ V}, R_L = 10 \Omega$ $I_D \cong -1 \text{ A}, V_{GEN} = -10 \text{ V}, R_G = 6 \Omega$	15	ns
Rise Time ^b	t_r		21	
Turn-Off Delay Time ^b	$t_{d(off)}$		35	
Fall Time ^b	t_f		45	
Source-Drain Reverse Recovery Time	t_{rr}	$I_F = -2.4 \text{ A}, di/dt = 100 \text{ A}/\mu\text{s}$	66	

Notes

- a. Pulse test; pulse width $\leq 300 \mu\text{s}$, duty cycle $\leq 2\%$.
- b. Guaranteed by design, not subject to production testing.



SPICE Device Model Si9430DY

Vishay Siliconix

COMPARISON OF MODEL WITH MEASURED DATA ($T_J=25^\circ\text{C}$ UNLESS OTHERWISE NOTED)

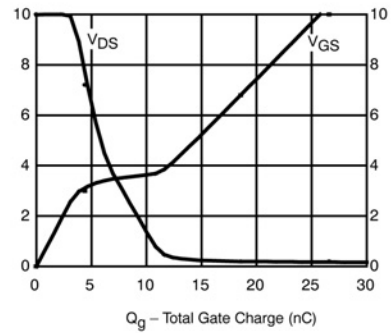
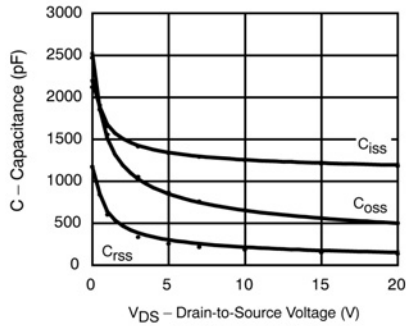
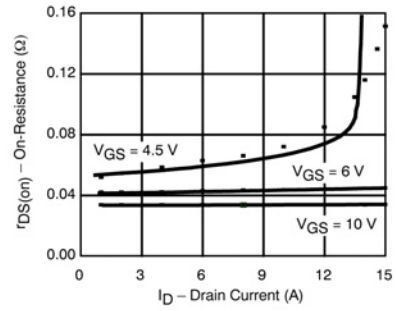
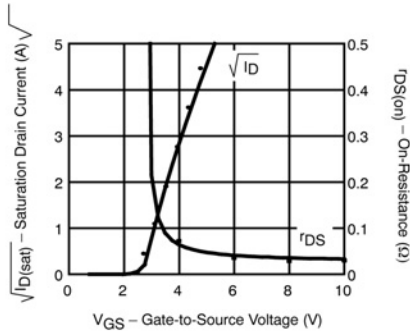
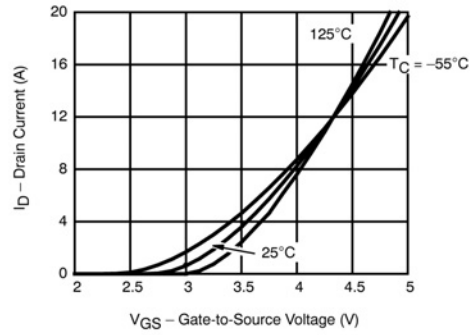
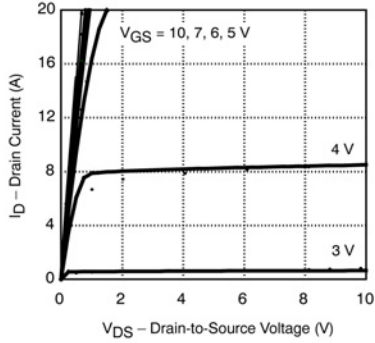

Note: Dots and squares represent measured data.