



MOS FIELD EFFECT TRANSISTOR

2SK827

FAST SWITCHING
N-CHANNEL SILICON POWER MOS FET

PACKAGE DIMENSIONS
(Unit: mm)

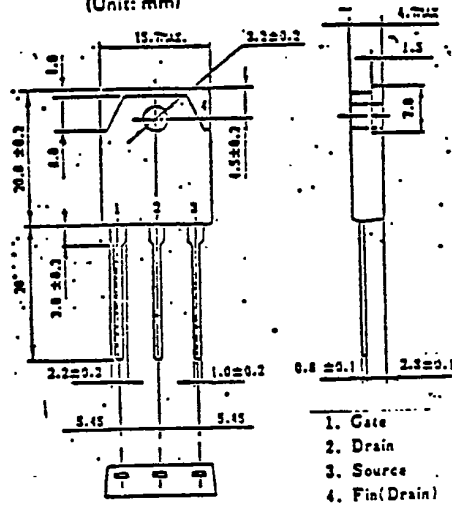

Features

Suitable for switching power supplies,
actuator controls and pulse circuits
Low RDS(on)

Absolute Maximum Ratings(Ta=25°C)

Drain to Source Voltage	VDS	450V
Gate to Source Voltage	VGS	± 20V
Continuous Drain Current	ID(DC)	± 18A
Pulse Drain Current	ID(pulse)	* ± 60A
Total Power Dissipation	PT	3.0W
Total Power Dissipation	PT**	120W
Channel Temperature	Tch	150 °C
Storage Temperature	Tstg	-55to+150 °C

* PW ≤ 300 us, Duty Cycle ≤ 2%
** Tc=25 °C

Electrical Characteristics (Ta=25 °C)

Characteristics	Symbol	Min.	Typ.	Max.	Unit	Test Conditions
Drain Leakage Current	IDSS			100	μA	VDS=450V, VGS=0
Gate to Source Leakage Current	IGSS			±100	nA	VGS=±20V, VDS=0
Gate to Source Cutoff Voltage	VGS(off)	1.5		3.5	V	VDS=10V, ID=1.0mA
Forward Transfer Admittance	yfs	8.0			S	VDS=10V, ID=0.0A
Drain to Source On-State Resistance	RDS(on)		0.32	0.38	Ω	VGS=10V, ID=0.0A
Input Capacitance	Ciss		2600		pF	VDS= 10V,
Output Capacitance	Coss		610		pF	VGS=0,
Reverse Transfer Capacitance	Crss		140		pF	f=1.0MHz
Turn-On Delay Time	td(on)		20		ns	ID=0.0A
Rise Time	tr		40		ns	VGS(on)= 10V,
Turn-Off Delay Time	td(off)		120		ns	Vcc=150V,
Fall Time	tf		55		ns	RL= 16 Ω

TURN-ON AND TURN-OFF TIME TEST CIRCUIT

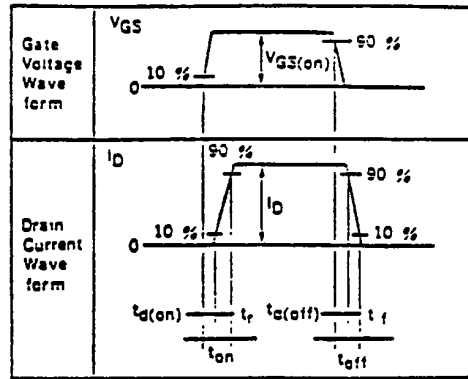
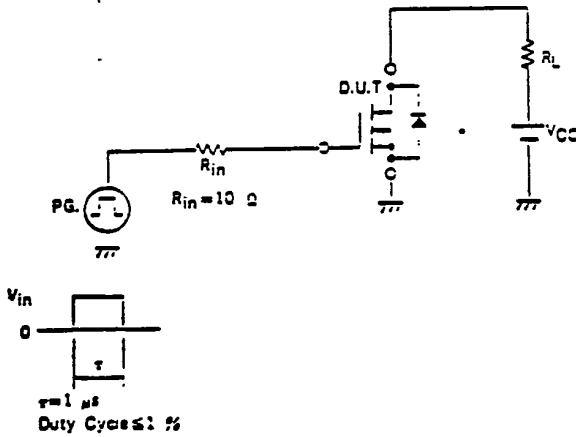

DERATING FACTOR OF FORWARD BIAS SAFE OPERATING AREA

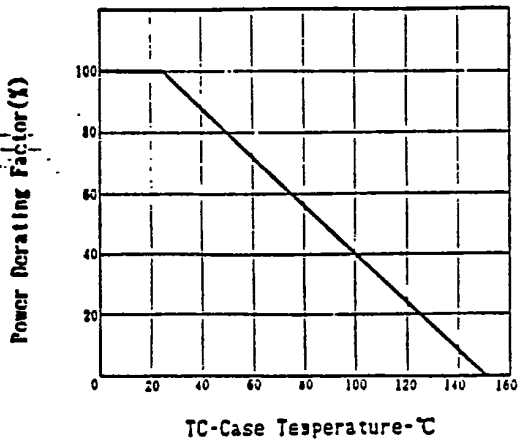

FORWARD BIAS SAFE OPERATING AREA

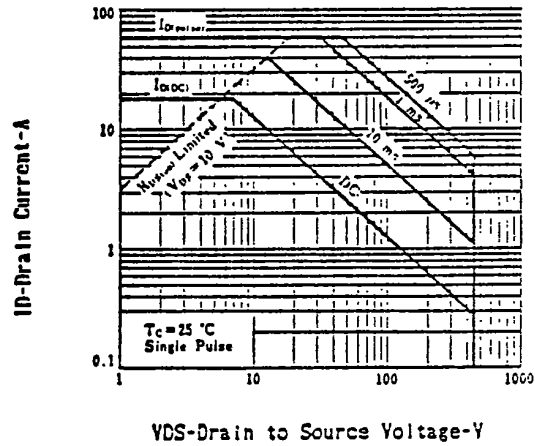

TOTAL POWER DISSIPATION vs. CASE TEMPERATURE

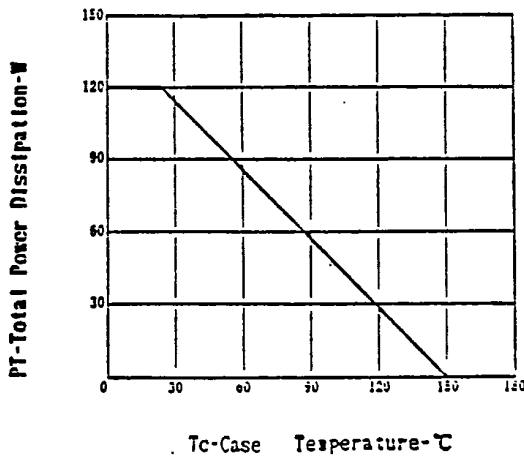

DRAIN CURRENT vs. DRAIN TO SOURCE VOLTAGE

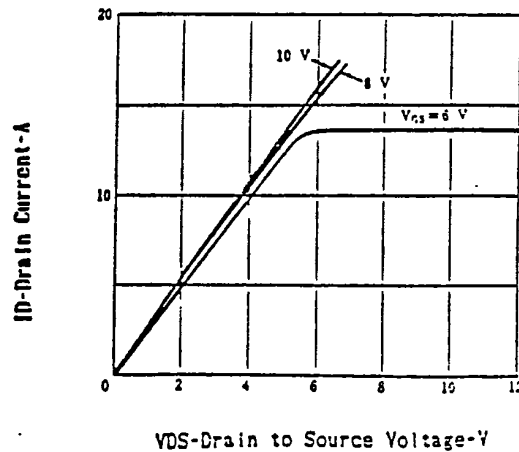

FORWARD TRANSFER ADMITTANCE
vs. DRAIN CURRENT

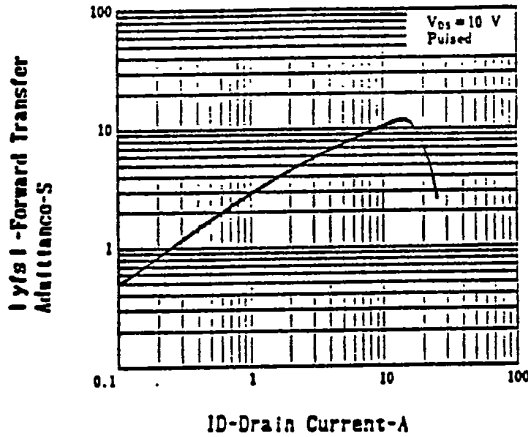

SOURCE TO DRAIN DIODE
FORWARD VOLTAGE

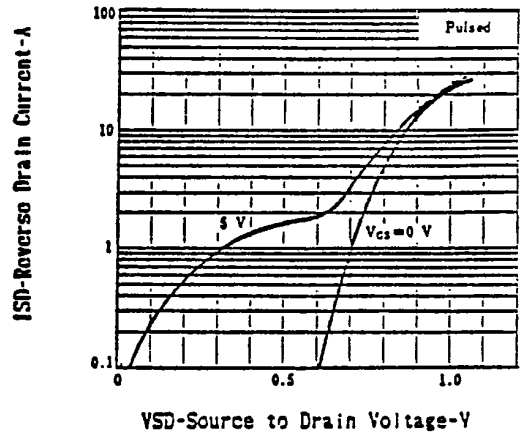

CAPACITANCE vs. DRAIN TO
SOURCE VOLTAGE

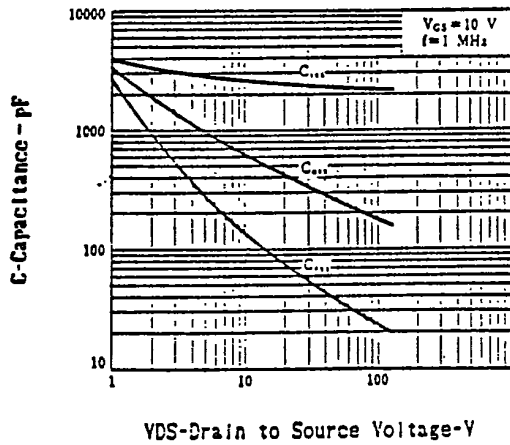

DRAIN TO SOURCE ON-STATE RESISTANCE
vs. GATE TO SOURCE VOLTAGE

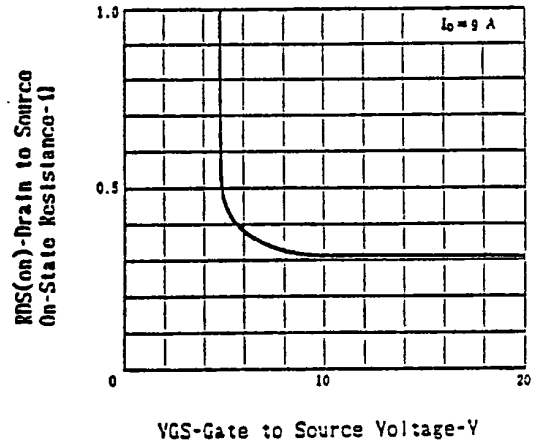

DRAIN TO SOURCE ON-STATE RESISTANCE
vs. CHANNEL TEMPERATURE

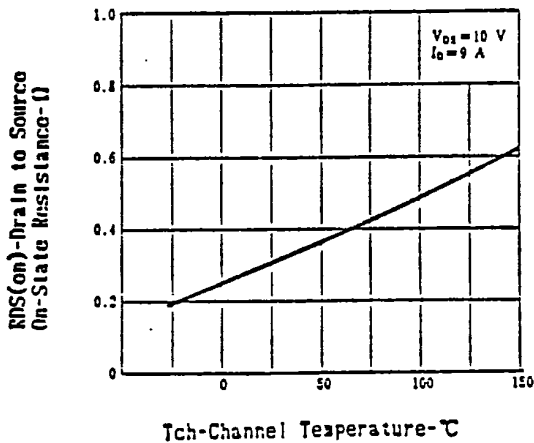

DRAIN TO SOURCE ON-STATE RESISTANCE
vs. DRAIN CURRENT

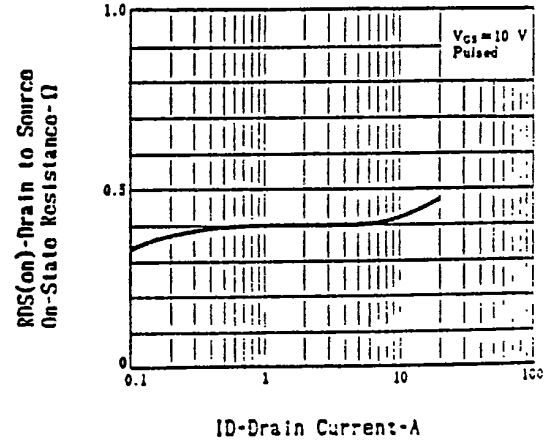

6427525 N E C ELECTRONICS INC

98D 19004 D

T-39-13

N E C ELECTRONICS INC

98 DE 6427525 0019004 2

TRANSFER CHARACTERISTICS

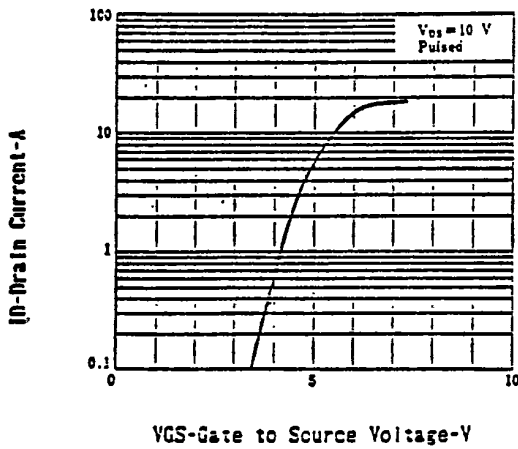

GATE TO SOURCE CUTOFF VOLTAGE vs. CHANNEL TEMPERATURE

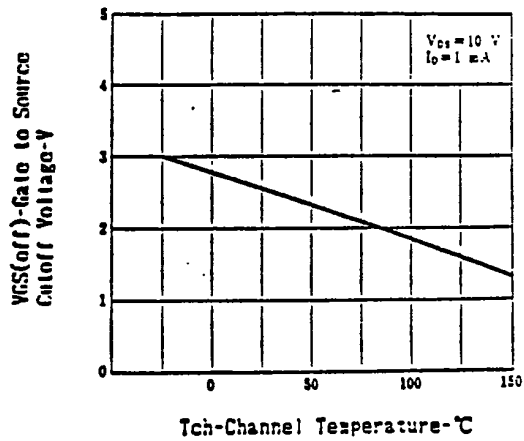

SWITCHING CHARACTERISTICS

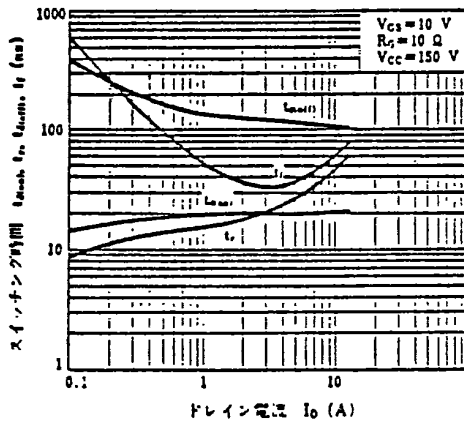

NEC Corporation

INTERNATIONAL ELECTRON DEVICES DIV.
 NEC Building, 33-1, Shioz Gochome
 Minato-ku, Tokyo 108, Japan
 Tel: Tokyo 454-1111
 Telex Address: NECTOK J22686
 Cable Address: MICROPHONE TOKYO

Printed in Japan